

Curtain Going Up

Everybody loves a live show. We feel a thrill of excitement as the house lights in the theater dim to black and the curtain rises on a stage play. Excitement in the audience runs like an electric current through the crowd and is, indeed, felt by the actors and crew members backstage as they wait in the wings.

That is the beauty of live theater. It is not like watching a movie on the big screen or on TV. Live theater is three-dimensional and interactive. The actors feed off the audience's reactions and, if the play is done well, the audience will become intricately involved with the characters and their actions on the stage. These are real people up there under the bright lights, putting their talents on the line to bring you a live performance.

If you can, go see a live theatrical performance of a play. If your town does not have professional theater or if the ticket prices for a show featuring paid, professional actors and expensive staging are too steep, go see a community or college theater production. Amateur theater is often surprisingly good and involves the talents and volunteer skills of many people to make the magic happen.

Of course, sometimes we are disappointed in a stage performance. Maybe the plot was ridiculous or the actors seemed wooden. Maybe the words—the dialogue—seemed stilted and not what real people would say. Or perhaps the lighting was off mark or the costuming was not in keeping with the historical period being depicted.

To earn the Theater merit badge, you will get to express your opinion as a theater critic and go behind the footlights to see the view from the other side. What you will find backstage

is that a lot of fun goes into making the illusion the audience sees. Theater also takes an enormous amount of hard work and creative imagination. Seeing a live play without knowing what's going on backstage is almost like seeing the tip of a huge iceberg from a ship. Much more goes on in theater than ever meets the audience's eye.

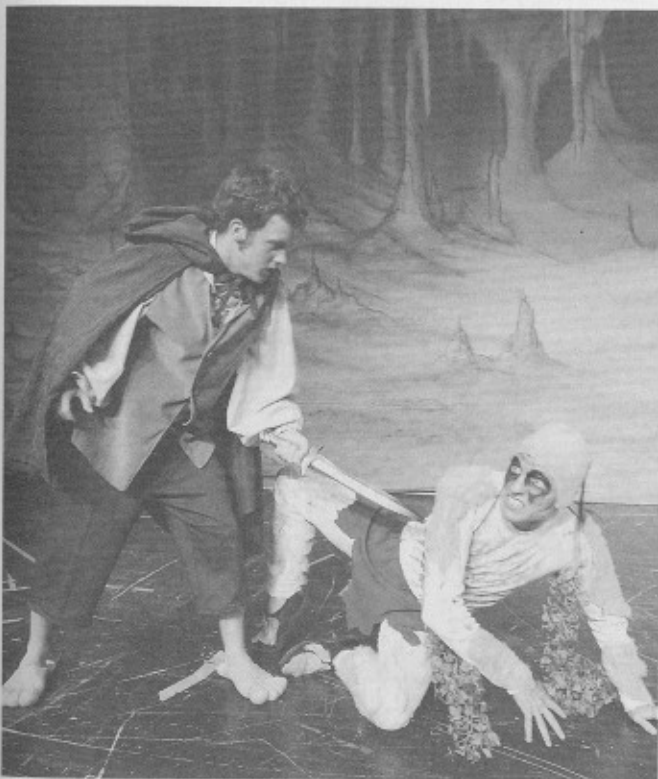

You will learn firsthand how a play is put together by writing a one-act play yourself and taking part in a production either on stage as an actor or backstage as a director or crew member. You will discover the art of communicating silently as a mime. You also will pick up some of the specialized language of theater. For instance, when a scene calls for an actor to "exit stage right," that means the actor will leave the stage to his right.

Stage directions are always given from the actor's perspective to make them easier for the performers to follow. The stage as seen through the audience's perspective, from the house or seating area of the theater, is called **house right** and **house left**.

Critical Thinking Skills

Many newspapers, as well as television and radio stations, employ people called *critics*. These people are specialists who review a special preview or opening night of a movie, play, live music, or art show. The critic describes the strong and weak points of a play, movie, musical performance, or art exhibit at the beginning of its run so that readers or listeners will have an idea whether they want to see it.

To fulfill requirement 1, you must view a play as a critic would. You will find that thinking critically about a play will teach you a great deal about the theater. First, consider all the elements that go into putting a play together. The director, whom an audience never sees, has coached the actors through each scene, telling them where to stand and how to best deliver their lines. A large degree of a play's success rests on the shoulders of the director and the actors.

Many other facets of a play can make it shine or sink it faster than the *Titanic*. These are called production values. Lighting, costume design, props, and stage-scenery or scenic design all contribute or can detract from the overall impressions you will glean from watching a play as a critic.

This is not to say you should not expect a few things to go wrong when you are watching a preview or opening night performance of a live play. Sometimes a piece of scenery not properly anchored to the stage will fall over right in the middle of a performance, creating a jarring effect. Sometimes a prop will not work right, like a phone an actor is supposed to pick up that does not ring at the right time. Actors are trained to work through these glitches and continue their performance without skipping a beat. Remember, in the best tradition of theater, regardless of what happens, "The show must go on."

In your review of a live play, you may want to mention whatever snafus occurred on stage. However, as a critical thinker, pay attention to how the actors deal with the situation. Offer a bit of praise if they rise above the problem.

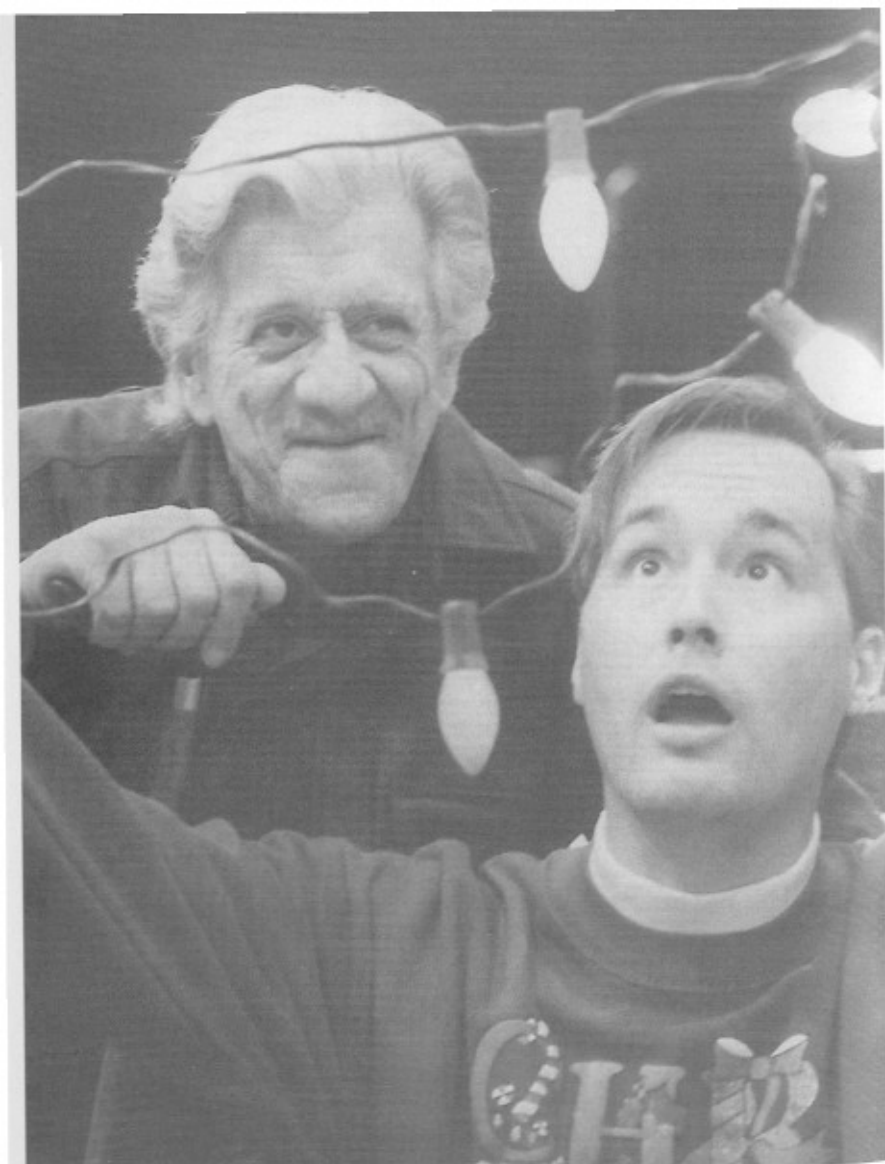

A scene from *Greetings!* by Tom Dudzick. Stage West Productions; photo by Buddy Myers.

Taking Notes

Whether you see a play on DVD in the comfort of your living room or experience the exhilaration of live theater with an audience around you, make sure you have a small, hand-sized notebook and a couple of pencils or pens with you as you watch the performance. If you are watching a DVD, you may have to play back the beginning and end of the film to jot down the names of the director, main and supporting actors, and production designers.

TV and Video. If you decide to meet requirement 1 by watching TV dramas, choose programs at least an hour and a half long. Chances are better that the plot, characters, and dialogue will be better developed. For example, try watching something from PBS's *Masterpiece Theater* presentations.

You can find a number of plays at your video store such as Kenneth Branagh's *Hamlet* or *Othello*, or plays by Horton Foote. Video is excellent for critical evaluation because you can rewind and see the same scene again to take in all the details. Also, seeing the same scene done by Mel Gibson as Hamlet and Kenneth Branagh as Hamlet gives you a good idea of how the same play can be interpreted in different ways.



Assessing the Show

If you are in a theater in front of live performers, be as quiet as possible while you jot down notes or turn the pages of your notebook. Do not write down everything that happens. Just make general notes about the various aspects of the play you observe.

- What actor's performance particularly impressed you?
- If it is an ensemble piece, how did each actor contribute to the group's success?
- How well is the play directed?
- How appropriate are the scenery, costumes, lighting, and props?

These are some of the questions you will need to ask yourself as a critic and write about in your review.

You may also form ideas during the performance or film about how the production could have been better. Maybe one of the actors could have performed better. Maybe you can't wrap your head around the story itself or find yourself not believing a character's motives. Your responsibility as a critic is not to be cruel but rather to give your honest opinion about the overall value of a play and the elements that went into making it a success, a failure, or something in between.

Don't forget the importance of sound when you are watching a performance. Plays that use microphones to amplify the actor's voices and require special effects sounds use a **sound board** to create the effects. From a desk, an operator takes cues from the stage manager ranging from special effects such as wind or rain, to mood music. When an actor turns on a radio or answers a phone, it is the sound board operator that really makes the appropriate music or ring come on.

As you describe the weak and strong points of a production, remember that you should not give away every aspect of the plot or the ending. Even though in this case the reader will be your merit badge counselor, critics should describe and illuminate various aspects of a play without giving away the plot. People will not want to see a play if the critic has already given away every detail.

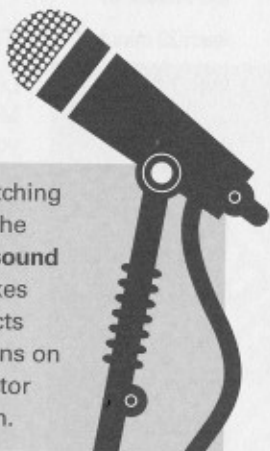

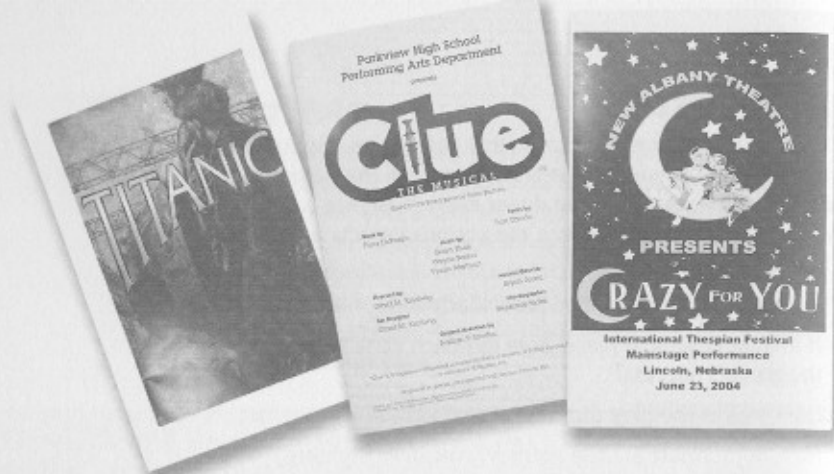

At the theater, you will be handed a *playbill*. This leaflet details the names of the characters and the actors who play them, how many acts or different parts of the play there are, and when the *intermission* will take place. Read the playbill before the play begins, and keep it so you can refer back to it as you write your review.

Theater Etiquette

Live theater is a different experience than going to a movie. Most people dress up a bit more to go to the theater. Also, you can't eat or drink while watching a play like you can a movie. The exception to this would be a dinner theater, where an elegant meal is served to patrons at their table during the performance, which is usually light theater fare such as a comedy or musical. You can stroll through the lobby during intermission for a snack or drink between acts. When the play is about to begin again, the lights will flick off and on several times to let patrons know it is time to return to their seats.

If you go to see a live show, try to get an aisle seat about seven to 10 rows from the stage. Avoid the front row because the sight lines to the stage are nearly straight up. Similarly, avoid the balcony or back rows of the theater if possible because the show will not seem nearly as immediate and live if the characters look the size of postage stamps and you cannot see the action in all of its detail.

Critics normally sit about seven to 10 rows back from the stage, on an aisle seat that is slightly to the left or right of **center stage**. This will give you an excellent view of the show and also enough light from the stage to write short notes to yourself as the play is under way. If you were a critic for a newspaper, you would have to leave the theater as soon as the play was over and write your review that very night. Having an aisle seat means you would be among the first patrons out of the theater and on your way.

Types of Theater Companies

Many large cities have *professional theater* companies that pay their directors, actors, designers, and crew members for their professional talents. Ticket prices will be higher (check for student ticket deals), and you can expect the acting and production values to be of the finest quality. Because these are trained, well-paid performers working on a set that has been designed and created with a great deal of financial underpinning, as a critic, you would be much more critical of a professional theater company than of an amateur theater group. Most professional theaters receive much of their funding from government programs for the arts, wealthy private patrons, and ticket sales.

You will find *community theater* organizations all over. These are true labors of love on the part of the local citizens and represent the best way for you to break into theater should you decide to pursue this art form further. Tickets usually are affordable.

Community theater is a volunteer's paradise. People from all walks of life—teachers, students, waiters, mechanics—participate in community theater as a passionate hobby. People who like to act, direct, design, build and paint sets, sew costumes, handle lighting, or serve in any number of roles from ushers to stage or prop managers come together to put on productions. In this setting, everything—from costumes to lighting to staging to the directing and acting—is done by volunteers on a shoestring budget.

center stage.

Literally, the space at the very center of the acting area.

It is also slang for being the focus of the audience's attention.

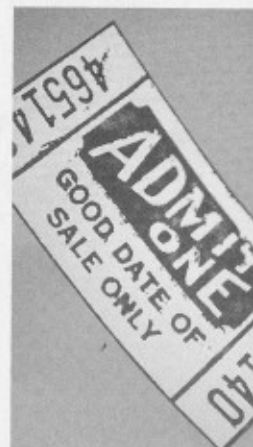

Word to the Wise. Arrive at the theater at least 20 minutes before curtain time. Never enter a live play late—it is a distraction to the actors and audience members alike to have someone fumbling in the dark to find a seat.

In community and student theater, costumes may be created from thrift store and garage sale finds or come out of a volunteer's personal closet. Props may be fashioned from toys or everyday household items. Scenery may be simply painted cardboard cutouts. Lighting may be done as inexpensively as possible with colored light bulbs and the use of a simple rheostat to dim and brighten the action onstage, a far cry from the high-tech computerized lighting board you would find on a professional theater production on Broadway in New York City.

Towns with colleges and universities that have theater departments offer student productions so that their drama students can get firsthand experience in the theatrical arts. In both community and college theater, you should expect both the action on stage and the production values to be of a different quality than what you will find in professional theater. As a critic, you would hold amateur productions to a different standard than what you would expect to see from professionals. Your assessment of the quality of the productions should be based and judged in part on what resources the company has to produce the play. Keep these things in mind as you write your one-page reviews.



How to Review a Play

The plays you will see or scripts you will read will likely fall into one of three broad categories: dramas, comedies, and musicals. There are advantages in reading plays and other advantages in seeing them. If you read a play, you are more likely to notice strengths and weaknesses in the story itself than if you only see the play performed.

On the other hand, because plays are written to be performed rather than read, you are more likely to see the full potential of the play if you see it performed. Either way, you must look at the play through the eyes of a theater critic.

Suppose you are going to meet the requirement by seeing three plays. Take your notebook to the theater or sit down with it in front of your television set. Concentrate on the play. Let yourself be entertained, but at the same time, keep the following in mind and jot down notes that pertain to these elements.

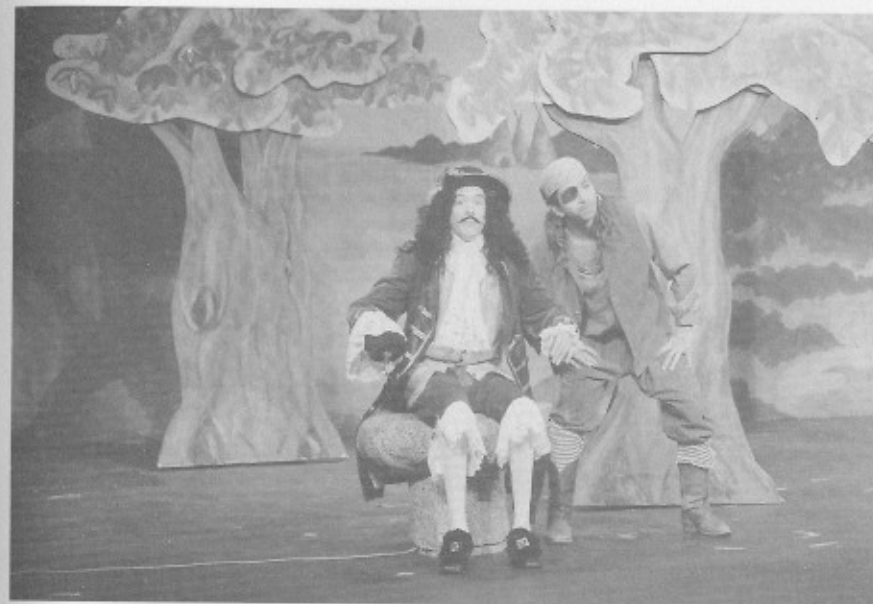

Do you believe in the story? Is the plot believable? Of course, in a fantasy play like *Peter Pan*, you do not really believe. But if the story is good, you can suspend your disbelief. That is, you will be persuaded to set aside your doubts if a fantasy is so good that it makes you believe that it could happen that way—if people could fly, boys never did grow up, and Neverland really did exist.

The actors should seem like real people and not like, well, actors. Ask yourself if the words and actions of the actors portray the way people in that situation would behave. If the show is a comedy, the actors' timing, the comedic pace, and the rhythm with which they deliver their lines and play off one another can make or break a play's success.

In dramatic plays, think about whether the actors are hitting their mark in portraying their individual characters. Are they overacting or *upstaging* (overshadowing) another key player in the scene? Do the characters on stage have good chemistry, or does it seem as though they are delivering their lines woodenly, without listening to the other characters or connecting with the audience? A play should stir your emotions—love, hate, anger, joy, sympathy, grief, elation. It should not leave you feeling blah.

A scene from
Peter Pan, Haltom
High School Theatre
Arts presentation,
Fort Worth, Texas



A scene from *Fences* by August Wilson. Stage West Productions; photo by Buddy Myers.

Aside from the acting, are the costumes right for the play? The lighting? Is the setting just right? Is it well-executed by the set design?

Lastly, ask yourself how the play could have been better. Perhaps a different twist to the plot would make it stronger. Or the feeling would be more dramatic if one of the characters were different—an old wizard instead of a young one, for example. Or a weak man rather than a brave one. Maybe a secondary character overshadowed the main character, who should be the center of interest at all times.

Ask yourself these questions as you watch and make notes. As you develop your critical thinking skills, you will get better at deconstructing what you are watching and breaking down the play into its smaller elements. Write down brief but clear opinions about what you are seeing and comment on each broad aspect of the play as you watch.

If you are reading a play, you can't comment about such things as the directing, costumes, stage sets, or lighting. However, you can still review the story and the dialogue—the conversations between characters—with a critical eye.

Soon after you have finished reading or seeing a play, write down your ideas about the plot and how successful the play was. Were all the loose ends tied up? Does the *foreshad-*

owing (the “hints” or “clues” about what is to come) become clear? Don't wait. Write down your impressions while they are fresh in your mind.

To complete requirement 1, your review does not need to be long and elaborate like a newspaper theater critic's. Each review can be about a page long. If you see a great many things to write about, you may want to make your reviews longer. However, you don't need to analyze each production as thoroughly as a professional critic would.

Backstage on Broadway: The Hour Before Half Hour

Here is what goes on during that crucial time before the curtain rises on a Broadway production. An hour and a half before curtain, the stage managers, stage hands, and lighting and sound crews are onsite, along with the prop crew and wardrobe personnel. A half-hour before curtain is the latest the actors can show up at the theater.

One hour before that last half hour, the sound crew checks microphones, charges batteries on mic (microphone) packs, and distributes the mics to the actors' dressing rooms. If the show is a musical, the sound crew also checks the mics used by background singers at the foot and the back of the stage.

The prop crew sets all the props for the entire show and places those to be used in the first act on stage in position. They shift and rotate the offstage props as needed. The prop manager goes through the prop list to make sure all props, from spoons, forks, a knife, or a gun—anything used or touched by the actor—are inventoried and on hand.

The wardrobe crew has laundered, ironed, and made repairs on all clothing and now ensures the actors' costumes are in their dressing rooms. For quick changes, they put wardrobe pieces to be hung at **stage right** or **stage left** on *deck level* (stage level) in place.



stage left,
stage right. The
sides of the stage
as seen through
the actors' eyes
when facing
the audience.

Basically the entire show is set up so that as things move offstage into the wings, other props and costumes move into position, ready for use in a later scene.

Lighting, although it is designed and *set* before the show's opening night, is checked cue by cue to make sure all lights are working properly. The lighting operator brings up each light cue by computer, checking to make sure all lamps are working and that the lighting gels that give the lights their color have not melted.

On Broadway, there are *stage managers* for stage left and stage right who are responsible for everything that happens on deck level. They have cue sheets and check to make sure all props are in place. They supervise all of the backstage crew's work.

The head stage manager *calls the show*, barking out sound cues, light cues, and prop cues over a headset. If you listened in, you might hear the stage manager say something like, "Cue 82, pick up the light

and pinspot actor in chair. Cue 83, bring up light on actor sitting opposed to him. Cue 84, bring on the desk. Cue 85, lights go to half (sunrise to sunset)." The stage manager has the entire script and calls the whole show.

A half-hour before the show and 15 minutes before the show, the actors and backstage crew are given notice. "Half-hour call!" "Fifteen-minute call!" Five minutes before curtain, the actors and crew are given their "Places!" call, which means everyone backstage should be in proper position. If an actor is supposed to be sitting in a chair on stage when the curtain rises, he should be sitting in that chair five minutes beforehand. Then the stage manager checks with the *house manager* (in charge of everything that takes place on the audience side of the theater) to make sure there are no problems in the house or with seating. The next call is "Curtain up!" just as the curtain rises.

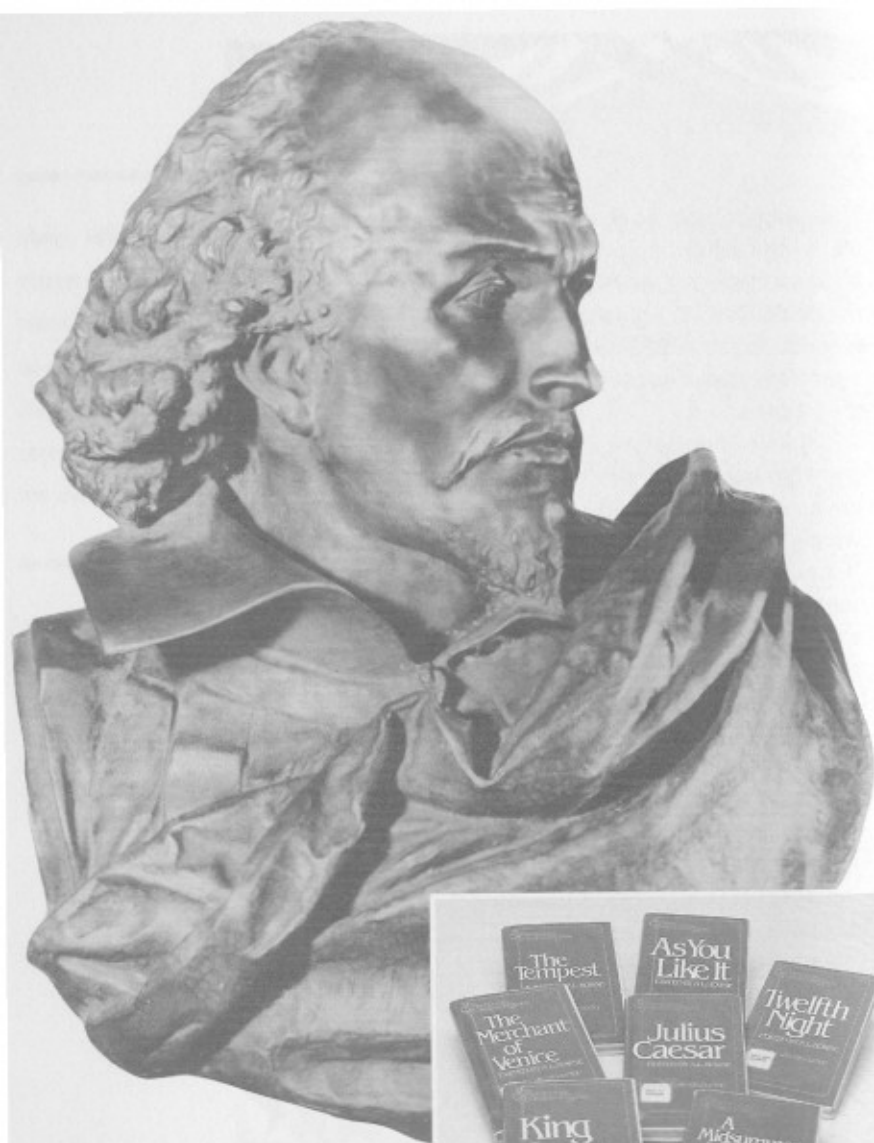

Playwright William Shakespeare
(1564–1616)



Writing a One-Act Play

For requirement 2, you become the playwright and get to pen your own one-act play. You will develop a great deal of respect for playwriting and the theater process as you go along. Good playwrights have perfected their skills over a long period of time and with lots of practice.

A playwright gets a dramatic idea for a plot or imagines a main character and then makes up a situation for that character to unravel. As a playwright, your task is to find a single dramatic idea and then make that idea live on stage by surrounding it with characters drawn from life.

First, decide on an idea for a plot. For example, say your plot involves two Scouts on a backpacking trip where everything goes wrong. Perhaps the two Scouts are arguing over which one forgot to bring the tent poles while their only dinner burns on a camp stove. Meanwhile, more bad luck—a storm is starting to brew. As one Scout is walking away angrily from the argument, he trips over a tent stake, falls onto some rocks, and breaks his leg.

The other Scout first thinks the other is faking and makes fun of him. But when he sees his friend is actually hurt, he quickly puts his own anger aside, makes a splint, and helps his fellow Scout out of the woods. As they are walking out, the two weary Scouts wind up friends again, laughing over the huge number of things that went awry on their backpacking trip. They vow to be better prepared next time and will not risk their friendship again over petty arguments.

If you get an idea that you think would be good for a play, ask your merit badge counselor or your English or drama teacher about it. Chances are good that one of them will be able to tell you whether your idea can be developed into a drama.

In the simple drama you are trying to write, the most important thing is to have some type of *conflict*. This conflict

might be between the wills of two people (such as in the example above), or a person struggling against a natural force such as a flood or tornado, or a character dealing with some aspect of life such as a strict new dress code at school or a big brother going off to war or college.

The point is, there will be some kind of conflict in your play, and the conflict will be resolved somehow. In the simplest terms, your plot might be, "Boy meets girl, boy loses girl, boy wins girl back." It is up to you to decide who and what you would like to write a short one-act play about. Just make sure it is a simple plot and that you can envision how you would stage it.

Neil Simon has been described as one of America's most successful and prolific playwrights.



Playwright August Wilson received a Pulitzer Prize for his play *Fences*, about a father who forbids his son to accept an athletic scholarship.

Finding a Character

One good way to find a plot for your play is to think about people you know. Often you can develop a plot by starting with a particular person you know well, someone who has an outstanding character trait.

For example, perhaps you know a Scout who sets a good example of a person who lives by the Scout Law. You could take this Scout and place him in a situation where his character is tested. You might make him the son of a poor fisherman who has a chance to get a great deal of money for college by doing one tiny dishonest act that only he will ever know about.

There you have the seed of a drama. The Scout would be the main character. The conflict would be the Scout's struggle against wrongdoing. The climax of the play would be the point where he makes his decision.

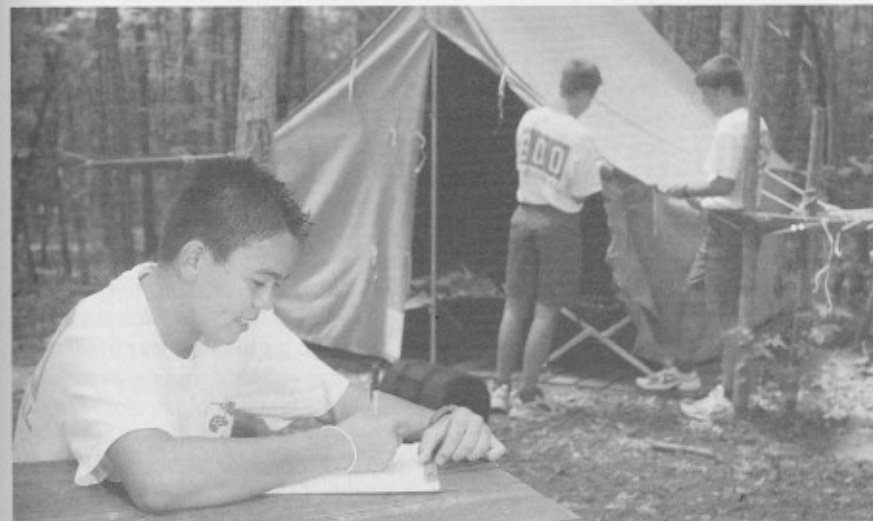

Everyday activities and people you know can give you ideas for a plot and characters.

Write your play about things you know, and pattern the characters in your script after people you know and understand. Do not take a chance on a subject or setting you know little about. If you do, the story and the characters are likely to sound false. If you believe in the characters and the plot, your audience will, too.

Creating a Scenario

Before you write your play, make an outline, from the opening words through the climax or big scene, to your final dialogue. This is called a *scenario*.

A scenario is an important step in writing a play. If you do not plan out your drama, you will find yourself rewriting and rewriting it. Even though your play will have only one act and one set, you need a scenario to keep on track from start to finish. As you write, you may make changes in your scenario, but at least it will keep you from wandering off into dialogue that does not advance the plot toward its climax.

As you develop your scenario, you must keep in mind your setting—what it looks like and where each of your characters will be at any moment. Prepare a short biography of each of the most important characters to help bring them to life.

Using the example again of the two Scouts on the disastrous camping trip, it is not enough that you know both of these boys are Scouts. Describe what they look like. What are their personalities like? Tell about their background, where they come from, and their individual quirks and values. Such facts about your characters may never enter your drama, but if you have each character fixed in your imagination as a living person, it will be easier for you to bring your drama to life.

Writing Dialogue

If you have never listened closely to a group of your friends talking on some subject, try it. You will be surprised at how disjointed their conversation seems when you pay close attention to each sentence. The exchange is likely to be full of “wells” and “uhs” and “you knows.” Yet, somehow, all the sentences finally come together in a meaning everyone understands.

The challenge in writing dialogue for the stage is cutting out all the unnecessary phrases—everything that is not vital to the story or the characterization—and at the same time maintaining the flavor of natural speech. If you are writing a dialogue between two Scouts, they must sound like Scouts—not like college professors or little boys. At the same time, you must compress their speech. If you wrote down exactly what two Scouts might actually say, you would have so many words that your audience would fall asleep before you reached the climax of your play.

Here are a few things to remember when writing dialogue.

Make it easy to say. Avoid tongue-twisting words, and keep sentences short.

Read it aloud. If a Scout is speaking, does his part sound like a Scout, or does it sound like the speech of a senator or an announcer on TV?

Does the dialogue move your story along toward its conclusion? Do not insert a joke in the dialogue unless it advances your plot or tells the audience something about one of your characters. You might like the joke, but it will distract the audience unless it fits into the story.

Trim the Excess

A one-act play written by a professional playwright would probably run about 10,000 words—about as much as a very long short story. As a beginner, you won't want to write that much. Your play should be about 10 to 12 handwritten pages or eight to 10 typed (double-spaced) pages. This will give you enough room to develop one dramatic idea and resolve it. You will not have much room for embellishments or for a deep exploration of the people in your play. But it will give you a feel for the art that is at the center of the theater experience.

Just remember to edit your play after you write it. Trim anything that does not advance the plot of your play or give your audience some insight into your characters and their motives.

Study This Sample Play

Let's take a look at a sample play by expanding on the disastrous camping trip example so you can get some concrete ideas on how to begin writing your scenario and your own play.

First, we need to develop brief biographies for the two Scouts in the one-act play, which will be called *Campout Chaos*.

Tank Morgan: Age 14, Star Scout, athletic build, captain of his junior high football team. Loves sports. Loyal, trustworthy, gregarious and outgoing, friendly, and a lifelong friend of Garrett Miles. Fairly disorganized both in school and in his personal life, he struggles to stay eligible to play football because his grades are not great. Leans on his best friend, Garrett, a great deal to keep him organized because he can't seem to do it himself.



Garrett Miles: Age 14, Life Scout, mechanical, a computer nerd, likes gadgets, working on cars, video games, backpacking, and is actually reading every word of the A to Z encyclopedias in his spare time. Bookish and bright. Slender, quiet, good-looking but shy. Meticulous about planning and highly organized, Garrett always has everything he owns in working order and seems to have every tool or item needed on Scout outings. Although he thinks of Tank as the brother he never had, Garrett is getting a bit tired of Tank just assuming he will pick up all the pieces that Tank seems to regularly let fall by the wayside.

Now that you have the main characters in mind, the conflict will be between these two, and the climax will be at the height of the dreadful camping trip during which there is an emergency and their lifelong friendship is tested.

Let's create the scenario.

The scene is a rocky ridge where Tank and Garrett are trying to raise their tent. Tank, however, has forgotten to bring one of the tent poles so the tent is basically at half-mast, drooping in the back. Nearby is a camping stove with a one-pot meal cooking on it. It is late afternoon on a cold autumn day. There are a few downed tree branches around their hilltop campsite and rocks below them. Their backpacks are nearby. One backpack is neatly packed and seems to have everything a camper could need such as rope, a camp shovel, rolled sleeping bag, mess kit, etc. The other pack is nearly empty and sloppy-looking. The painted backdrop shows thunderheads looming in the background.

As the play opens, Garrett is joking with but frustrated with Tank, who was responsible for bringing the tent, for not checking to make sure it had all of its poles and enough tent stakes. Now they have hiked 10 miles from the trailhead and it is too late to go back. Tank is shrugging off his lack of organization and suggests they just forget the tent and sleep outside in their sleeping bags. Garrett is watching the sky and thinks they are in for a huge storm.

While Garrett and Tank are trying to fashion a downed tree branch into a tent pole and messing around with the tent, the one-pot meal boils over. The tree branch the boys have been working on breaks in two and the tent sags again.

The friends start bickering over who forgot what, who ruined the dinner, and whether it is going to storm or not. Pretty soon the two are accusing each other of idiotic things that happened between them long ago on troop campouts. What began with friendly kidding has escalated to in-your-face yelling.

Tank marches back to the tent to drag his sleeping bag out into the open. He has decided to sleep outside and to heck with the weather and his best friend's opinions. He tells Garrett if he was so worried about the tent, he should have checked Tank's backpack beforehand. Garrett, usually quiet, is about to fly off the handle.

Just then, Tank stumbles hard over a tent stake and falls flat on his back. A huge clap of thunder booms at the same time and nearly drowns out the sound of Tank's voice.

Garrett thinks his buddy is just faking it and is sure Tank will jump up and tackle him teasingly if he shows the least bit of concern. Plus he wants to point out to Tank that he was wrong about the storm. But Tank does not get up, does not reply, and when Garrett goes to check on him, he realizes from the look on Tank's face that he is in great pain.

Garrett quickly puts his anger aside and carefully kneels beside his friend. He quickly assesses the situation and tells Tank he has broken his leg. Tank's leg is throbbing in pain; he tells Garrett there is no way he can walk and there is no way a skinny little guy like Garrett can carry him out. Garrett doesn't want to leave Tank behind in the approaching storm to go for help. He scrambles around for some rope, his knife, and grabs the lone tent pole to fashion a splint. As Garrett is splinting Tank's leg, the reality of the situation has dawned on Tank.

Garrett splints Tank's leg and gets the big guy on his feet. The storm sounds nearer, with thunder rumbling in the background and lightning on the horizon. As they are walking off the stage together, Tank limping badly with his arm slung over Garrett's shoulder, Garrett laboring under the weight of his larger friend, Tank apologizes for being so careless and disorganized. Garrett accepts the apology. The end scene shows the friends walking off together teasing one another once again in a friendly way, laughing about the chaotic campout where everything went wrong.

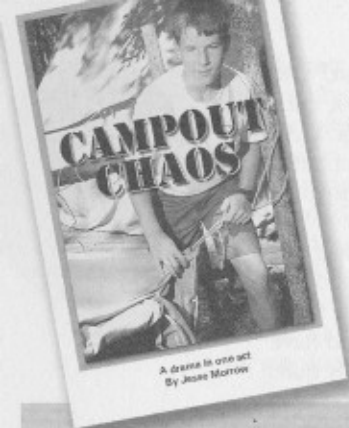

That is the scenario for the play. It is nothing but a skeleton that will need a good deal of fleshing out, but it gives an outline to follow in writing the dialogue.

The Script

The opening dialogue for this sample one-act play presents the basic format your finished script should follow. This is not the whole play, just enough to give you the idea.

Notice that the stage directions are underlined and enclosed in parentheses. As you prepare your own script, you will want to add occasional stage directions and advice for the actors on how a line should be said. Do not overdo this. The director will be in charge of bringing your play to life on stage. Leave most of the directing to the director.

CAMPOUT CHAOS

A Drama in One Act by Jesse Morrow

Characters:

TANK MORGAN—athletic, outgoing Scout

GARRETT MILES—small, bookish Scout

Scene: The scene is a campsite. At left, the audience sees GARRETT standing with his hands on his hips as TANK emerges from a half-raised tent with one tent pole missing in back. Beyond the sagging tent is a menacing bunch of thunderclouds on the horizon. At right is a small camping stove bubbling with something cooking in it. Two backpacks, one outfitted correctly for a Scout, the other nearly empty and sloppily put together, lie on the ground. Downed tree limbs are scattered around.

GARRETT: Tank, remember the conversation we had right before we hiked eight miles in here when I asked you if you'd packed both tent poles and all the tent stakes?

TANK: I must have left the other tent pole in the garage. I'm not sure what happened to the rest of the tent stakes. It's no big deal, Garrett, let's just rough it tonight and sleep outside in our bags.

GARRETT: Dude, have you checked the horizon? Look at those thunderheads!

TANK (crawling out of the tent, smiling): OK, Chicken Little, take it easy. A little rain isn't going to kill us. Let's make one of those limbs into a tent pole.



GARRETT (looking around at the downed branches): Most of these branches are rotted through. There's no way they'll hold up a wet tent.

TANK (looking playfully toward the camping stove, where the pot is now boiling over): Don't be such a cynic. It's not going to rain. Hey, what are you firing up for dinner there, Chef?

GARRETT (suddenly turning around and remembering the stove he walked away from to deal with the tent): Freeze-dried beef stroganoff—oh, man, look at that. It's totally ruined.

TANK: I could eat a bear and a moose for dessert after that hike. What else did you bring?

GARRETT (turning off the stove and plucking the hot pot off with his rolled-up jacket): Me bring? You were supposed to bring the food and the tent for this trip. I brought everything else, remember? I just happened to have that packet of freeze-dried stuff in my backpack.

TANK: That's it? We don't have anything else to eat?

GARRETT: That's right, Tank. Oh, did I forget to mention the tent at half-mast—and the storm that just happens to be scratching my back?

TANK (marching off toward the tent): Yeah, and the sky is falling and no one will listen to you. Lighten up, dude.

GARRETT: Sure, no problem. Just like the last three campouts we went on, remember? You completely blow off your end of things every time. Nothing ever changes.

TANK: You're the one who's always prepared for everything, Garrett. You should have known I wouldn't have my act together.

GARRETT: What? You want me to check your pack before every campout? To make sure you packed everything you said you would? I'm not your mama.

TANK (grabbing his sleeping bag out of the tent and punching it hard): Look, bud, the storm's going to pass in couple of minutes, and we won't starve without one dinner. I'm sleeping out under the open sky tonight. We're Scouts, remember? We're supposed to be tough outdoorsman. Why don't you go tie yourself in a bunch of knots with all that rope you brought. Just get off my back.

(TANK turns away sharply and tumbles over a tent stake, falling on his back. TANK cries out as he falls. At the same time a clap of thunder rumbles in the background, nearly muffling out his cry. The sky grows darker as GARRETT dries off the camp pot and repacks it in his backpack.)

TANK: Ooof! Aaaaaaaaahhhhh!

GARRETT (looking toward where TANK has landed): Tank? Come on, you faker. Sure, the captain of the football team falling over a tent stake and landing flat on his back. Get up and help me find a branch to hold up this tent.

TANK (grabbing his lower leg, wincing in pain): Oooohhhh...

GARRETT (alarmed, peering toward Tank in the growing darkness): TANK? Are you all right?



* * *

Writing Your Own Play

When you have your characters and setting in mind and have completed your scenario, start writing your own play. As you write, keep a few simple things in mind—not as rules, but as guides.

Early in the play, let the audience know who the characters are and what the problem is. In *Campout Chaos*, both characters are Scouts. The audience can tell this because Garrett refers to past Scout campouts they have been on and Tank states that they are Scouts and “supposed to be tough outdoorsmen.” It is also clear, at least to a Scout audience, that Garrett knows his Scouting. He makes it clear that he has brought everything he was supposed to bring and has overcompensated for his friend’s disorganization on more than one campout in the past. The audience also knows the root of the conflict between the two Scouts. One is normally prepared for anything; the other is careless and too carefree.

Plant some hints early in the play that will make your big scene or climax more effective. Try to increase the suspense as you build up to the climax. Then, put the climax near the end of the play.

An audience wants to know how a drama pans out. Once you have shown that, it will be hard to hold their interest much longer. In *Campout Chaos*, the climax comes when Tank breaks his leg and Garrett, the good Scout, utilizes the things he brought to render aid despite his anger at his friend. Tank, realizing he has been wrong about everything and that his disorganization led to a bummer of a camping trip and nearly the loss of a lifelong friendship, apologizes. He will probably be out of football for the rest of the season but he has learned a valuable lesson. The fact that these characters have faced difficulty and worked out their differences is emphasized by the fact that they can laugh and find humor in the situation after the fact. Then the curtain comes down.

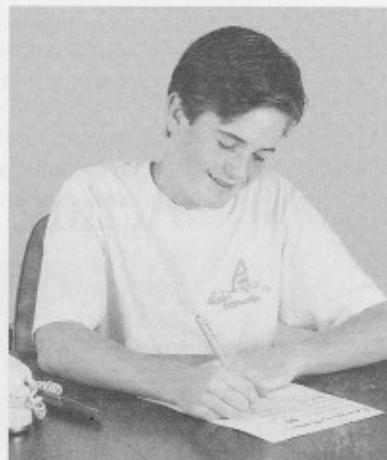

Acting a Part

When you were younger, you probably played make-believe all the time. You might have been a cowboy or a pirate or a soldier or any number of imaginative people you made up in your head. If you still have an active imagination and can envision yourself playing many different roles, this could be a sign that you will make a good actor.



If you feel comfortable trying requirement 3a, do it. In no other way can you get the same thrill of working in the theater than by acting a role on stage in a play. You can learn a lot about the theater process by filling other positions such as directing or designing, but if you are acting, then you are at the heart and soul of theater.

Maybe there is a drama club or class at your school that puts on plays during the school year. If so, join it and try to win a part. Perhaps your town supports a community or children's theater or summer stock theater. Community theaters often cast lots of children and young adults in seasonal plays such as *Scrooge* or *Joseph and the Amazing Technicolor Dreamcoat*, particularly around major holidays. These venues would give you an excellent opportunity to get acting experience and learn about every facet of the theater.

If these opportunities are not available where you live, how about your troop? Are there three or four other Scouts who would like to try their hand in the theater? If so, perhaps you could work with your counselor to plan a play for your next troop outing. It may not be Broadway quality, but it can be a lot of fun. At the same time, you will learn much more about the theater by taking part in an actual production than you would by reading all the books on drama in the library.

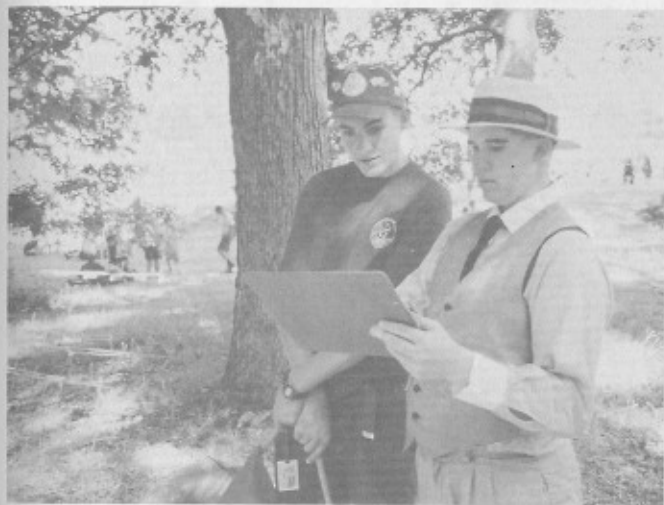

Qualities of an Actor

What qualities do you need as an actor? To begin, you need to be able to project your voice so that you can be heard distinctly in the back of an auditorium. You also need a good memory because you must be able to memorize hundreds of lines and bits of stage directions. A good memory is mainly a case of being able to focus or concentrate, and such concentration can be learned with practice.

You also need self-assurance—the confidence that you are capable of playing your part and the conviction that you can convince an audience to believe in your character. Self-assurance also comes with practice in front of people.

You need a good imagination. Without imagination, your character will not come alive. Ninety-nine percent of acting is imagination.



Danny Glover

With these qualities—most of which can be acquired—you can be a good actor. The greatest actors have an additional quality that is difficult to describe. It is a force of personality that energizes the audience as if a spark of electricity were passing back and forth between actor and spectator. Not everyone has that magic, but by working hard and studying, you, too, can become a fine actor.



Auditioning for a Role

When you audition or read for a part, do not waste valuable energy worrying about whether the director will like you. Get up there and show your stuff. If your audition starts out shaky, do not be afraid to stop and ask to begin again.

Occasionally, after a good reading, the director will ask you to read again and offer you an acting adjustment. Many times, that is done to see if you can take direction; it might not have anything to do with the scene or your own interpretation of the part. Other times, the director may be looking for different qualities in your persona or personality.

Portraying a Character

Once you have the part, the first and most important approach for the actor is to read the play and find out what the playwright wants to say to the world. *Who, what, where, and when* are some of the questions you should ask yourself when you first get a part.

Who am I? What kind of person is this character I am to play? As your character, you must know how old you are. What grade are you in, or have you already finished school? As your character, you must decide what your favorite color is, what your favorite food is, what food you detest, what your favorite TV shows are, the type of music you like or dislike, and so on. In short, you must know the same things about your character as you know about yourself.

What time is it? When does the action take place? What kind of day is it? Example: "It's 7 A.M. on Saturday and I am (as my character) getting ready for a campout. It's cloudy with a light rain falling."

Where am I? Where does the action take place? Example: "I am in my bedroom and it's a mess, so I have to spend time digging in the closet for my equipment. I can hear the sound of music coming from the stereo in my brother's room, which is down the hall."

What surrounds me? What objects are around me? Example: "My backpack is on the floor along with my camping gear, rain gear, clothes, swim trunks, and toothbrush."

What are the given circumstances? What is the situation? What events are taking place? Example: "My family has just moved here so this is a new troop for me. John, from three doors down, and his dad will pick me up in 20 minutes, and I'm not ready."

What do I want? What are my objectives? Example: "I want the other guys to like me. I want to make friends. I want to do a good job so others will respect me."

What is in my way? What obstacles confront me? Example: "I'm nervous and a little scared because I don't know anyone. I can't remember everything I need. I can't find all my gear."

What must I do to get what I want? What actions do I take? Example: "I make a checklist of everything I will need and check it off as I find things. I mentally make a list of funny stories so I will have something to tell around the campfire. I will volunteer to help teach others a skill I already know such as how to pitch a tent or pack a backpack."

Another important part of portraying a character is to know yourself. Know who you are and who your character is. Find your own sense of identity, enlarge upon it, and discover how that knowledge can be put to use in the characters you will portray onstage. Many directors will tell you that when you audition, it isn't just the reading that gets the actor the role. It is the actor's qualities, plus the reading, that does,



Your own identity and self-knowledge are the main sources for any character you play. Renowned acting instructor Lee Strasberg said, "If we cannot see the possibility of greatness, how can we dream it?" Sanford Meisner, a noted New York acting teacher, reminds us that acting is living truthfully under imaginary circumstances.

Mime

When you run around a track, lift weights, step into a pitch and swing toward the fences, or let loose on the dance floor, you are using your body as your instrument. The same is true in *mime*, a form of theater that requires you to communicate to your audience without words, using your body to express your ideas.

Before you start requirement 4, do some basic warm-up exercises. Run around a room, do leg stretches, move your arms in wide circles, do 10 jumping jacks. Then lie on your back for a couple of minutes and relax quietly.

Try an introductory mime exercise: Run around the room, shaking out your legs and arms until you are really loose. Make a lot of noise, any sound you feel like making. Then suddenly freeze like a stone. Do not move a muscle. Try not to let anyone see that you are breathing.

When you freeze, you are disciplining your body to hold perfectly still. You are also learning how to use your body's shape and lines to explore the rhythmic world of mime.

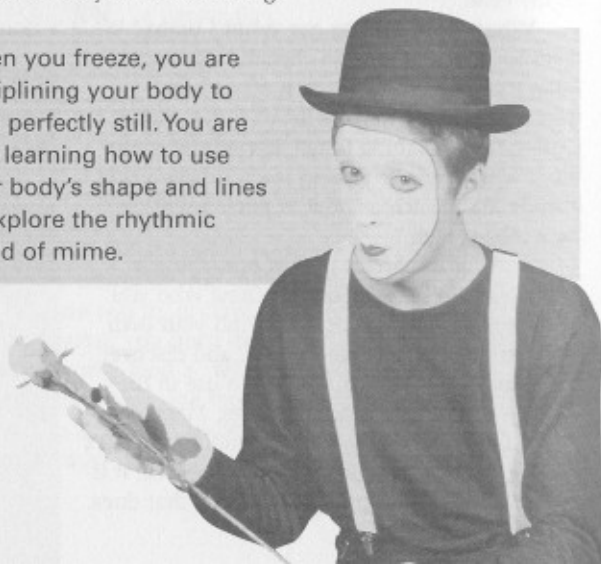

Now run and freeze again in any position you land in. Even though you are perfectly still on the outside, do not be a dead statue made of stone on the inside. Imagine that on the inside, you are full of energy, prepared at any second to spring into action. As a mime, this energy that emits from inside you makes you exciting to watch. It turns a simple game—playing statue—into a performance.

With a group, take turns freezing in the middle of an imagined activity, like swinging a bat, catching a football, or climbing a ladder. Do not use any props. Try to freeze in a position that reveals what you are doing. The group can then guess what the statue was in the midst of doing.

Try making yourself into a statue that shows a specific feeling, like anger, happiness, pain, or fear. If the group has trouble figuring out the emotion you are trying to express, spend time figuring out ways to improve your statue so your meaning is clear.

Next try some slow-motion exercises. You have seen slow-motion replays on television in football, baseball, and in Olympic sports such as skiing and gymnastics. When you see the athletes in slow motion, you can pick up the smallest details of their performance and the action that took place.

In mime, you can control your body and use the rhythm of slow motion—where there are no stops in the action, no sudden or quick movements. The rhythm never changes, it stays slow and constant from beginning to end.

Use your whole body when you are doing mime in slow motion. When you run in slow motion, use your whole body and shift your weight gradually from one foot to the other to keep the effect going. Exaggerate all of your movements. Try skating, shoveling dirt, hammering nails, or shaving your face in slow motion. Watch yourself in a mirror until your slow-motion rhythm is perfect.

Mimes also use *staccato* rhythm in performance. These are sharp, short, sudden movements separated from the others by a slight freeze in action. If you have ever seen anyone dance under a flashing strobe or disco ball, you have noticed that they look like mechanical people; their movements seem like they are separate frames on movie film.



Doing mime exercises can help your coordination, improve your physique, and help you better understand how people communicate nonverbally through body language in everyday life.

Charlie Chaplin, a famous silent-screen star, was a master at staccato rhythms. The short, snappy way he walked with his feet splayed outward like a duck, a cane perpetually swinging at his side, and the way he jauntily bobbed his head from side to side became his trademarks.

For requirement 4, practice one of the activities suggested in slow motion. Then try it in staccato motion. Remember to use your entire body and exaggerate each movement. Create situations that are funny, graceful, or slightly offbeat by exaggerating your facial expressions and isolating and defining your body's reactions to the situation.

For instance, if you choose requirement 4e, pretend that you *really* do not like the vegetable with your dinner, that it is as awful as eating a jar of baby food would be. Each bite would bring you closer to scooping the offending vegetable into your napkin and hiding it under the table—or feeding it to an imaginary dog.



The robot

One of the most well-known mime routines is "the robot." Robots do not walk or move like people do. Use shuffling, small steps and keep your feet close together as you slide across the floor. Turn on a dime sharply.

If you try robotic or mechanical man movements, you need to work in "neutral": In other words, you do not show

any emotion or facial expressions. Mimes often wear whiteface makeup to mask their facial expressions and neutralize their appearance and personality, which in turn makes their actions speak louder.

All work in mime starts with what is called the *neutral zero position*. In this position, you do not show emotion, thought, or action. Start all your skits from this position.

First, stand up straight with your heels together and your feet open about 4 inches. Tuck in your stomach and buttocks, thrust your chest out, keep your shoulders back and your arms straight down and hands loosely touching your thighs. With your chin in, try to create a straight line from the back of your head down to your ankles. Now relax your face. Open your mouth slightly so you do not look uptight or angry. Practice this stance and remember to let your inner spark shine through.

The word "mime" comes from the Greek word *mimos*, meaning "representation." Mime is the art of acting out a message or a saying that is abstract. For instance, a mime might act out the idea that he drinks all the cola from a soft-drink bottle, then climbs into the bottle and becomes trapped.

Pantomime

Pantomime is similar to mime in that it is also a silent art, but it retells a story, legend, or tale. Mime and pantomime both involve action instead of words. An everyday example is when the umpire crouches over a close play and spreads his arms wide with his palms down, telling the crowd in the stands that the runner is safe. In your classroom, when you raise your hand in answer to a question, you are using pantomime to tell the teacher you know the answer.

Pantomime has had a long, illustrious place in theater. Even today, many comedians use pantomime as an important ingredient in their performances.



Practice

For requirement 4, you must make up gestures and movements to suit the character you are playing. Practice your short skits many times before a full-length mirror and try them out on your family or friends before you perform for your counselor. Think through each situation and break it down into the precise movements and expressions you will use to convey exactly what you want your audience to see.

One basic practice technique in mime is "the wall." Think of yourself in this exercise as being confined in a box, a room, a bottle, etc. Be sure you know where your wall is. Begin with a fisted hand, then open it out and press on the invisible wall. Now do the other hand. Be sure to watch your hands. With a flick of the wrist, remove one hand from the wall, loosely fist it again, and put it back on the wall. Repeat the exercise.

Another practice technique is "the rope." Climb up the rope or pull on a rope. Imagine the rope is about 2 or 3 inches in diameter. Hold it in both hands with one hand farther out than the other. Let go with the near hand, and make a flat hand. Keep the rope hand in the same place and lean with your torso. Replace your hand and pull the rope with your torso, keeping the same distance between hands. Repeat.

Before you perform, observe people for a while. Note their facial, hand, and body expressions. As you practice your short scenes, remember body tension, facial expression, exaggeration, and the surroundings you have established. Do not walk into a "wall" or "table" or "bus" that you have already established is there.



The wall

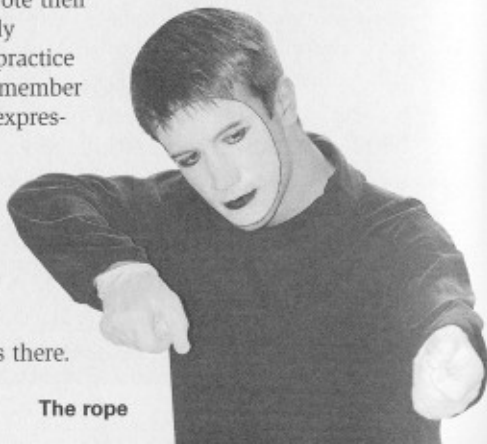

The rope

Ideas for Skits

Besides the five pantomime situations described in requirement 4, you can work up other ideas for skits. Skits should have a definite beginning, middle, and end—and a conflict and resolution. A good length for a skit is about 60 to 90 seconds.

Here are some ideas for pantomime skits:

- You are on a hike and enjoying the beauty of nature. You find a stick and throw it; it hits a beehive.
- (For two people) Bored, one person has an idea. You play tug-of-war; one person wins, the other sulks; then you make up.
- You are the first robot allowed to compete against humans in a sporting event.
- You are a traffic cop involved in dramatically directing traffic on a busy city street. A truck skids into the intersection and refuses to stop when you blow your whistle.
- (For a group) Make up a slow-motion replay of a sport like you would see on TV. Decide beforehand what will happen during the replay, what the outcome will be, and who will play each part.



Directing a Play

An author has written a play, a producer has decided to stage it, and now its fate is in the hands of a director. The director will be in complete charge of the production. What the audience finally sees will be what the director has achieved.

Probably most of the plays you will take part in will be produced and directed by an adult—perhaps a teacher at your school or the director of a community theater. So if you are going to direct a play for requirement 3b, you may have to organize your own players from among your friends and fellow Scouts. Perhaps you could stage the final performance at a troop meeting.

You may want to present the one-act play that you wrote for requirement 2. If that does not seem suitable, ask your merit badge counselor for assistance. Almost certainly you will find a play that interests you and falls within your ability to direct.



Visualization

Your first step as a director is to study the play you have chosen. For a full understanding of what the author is driving at, what sort of people the characters are, and the setting for the play, a director must read and reread the play. Before casting or planning any other details of the production, the director must “see” the play completely in his or her mind.

If you study a script carefully, you may find yourself imagining one character as noble but vain, tall, handsome, and a little neater in his dress than the average guy. You might see another character as a blunderer, slight in build, nervous, and careless in his clothes and grooming. Develop these images in your mind as you think about a particular play.

Casting

All of this study will be a big help to you when you begin casting the play. If your conception of the play's hero is a tall, dark-haired, handsome man, do not give the part to your best friend who is short, stocky, and fair-complexioned—especially if he is a poor actor. Try to fit the actor to the play character, rather than making the character fit the actor. This may take some tact and diplomacy, particularly if your best friend thinks of himself as a talented actor. But you must choose the right person for each part, or you will find your production drooping even before the dress rehearsal.

As the director, you have some other things to worry about while you are in the early stages of preparation—maybe even before you have chosen the cast: the stage itself, the setting, the costumes, the props, and the lighting. You will probably have to handle these duties yourself, unless you are lucky enough to be directing a fairly big production in your school or community.

How should you go about making your choices? There are several methods. Of course, if you have seen all the candidates perform before, you already know how well they can act. But suppose you do not know them that well. You might ask each one to read a short scene from the play. This will give you an

The author will not have filled in every detail about each character. The author probably did not reveal the physical appearance of all the characters and may have left gaps in revealing their personalities. Fill these in with your imagination, based on your knowledge of the script.

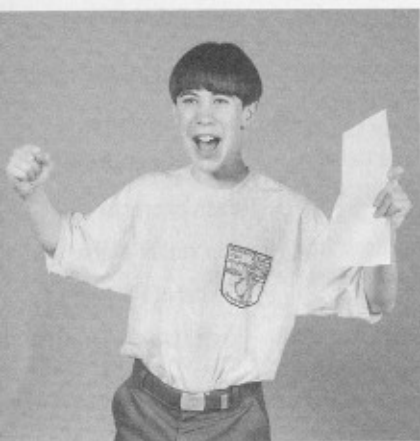

idea of how well they express themselves and their ability to project an emotion or thought.

Another good way to find out who can act best is by assessing each actor's feel for the story. Let each candidate read through the play. Then ask each one to perform a scene—not word for word, of course—by improvising and making up lines. These improvisations will help you choose the best actor for each part.

Once you have chosen the cast, stick to your choices unless it is absolutely necessary to change. Most people will not be offended if they are not picked for a role, but almost anyone would be hurt if he were removed from his part without a very good reason.

Rehearsing the Play

Cast members should be prepared by practicing their lines even before the first rehearsal. At the first rehearsal, have the actors read through their parts and begin to learn their lines. During the second rehearsal, talk to them about the movements you want them to make. You and each of the actors should have a script to work from, and even before the first rehearsal, you should have made some notes on your script.

Your notes should include what you want each actor to be doing and where he should be on the stage during each scene. You might want to make changes later, but you should have some ideas before rehearsals start.

When you have decided these things, your actors can make notes in their scripts about these movements. This process of planning the stage business is called *blocking*.

By your third or fourth rehearsal, the cast members should know their roles well enough to run through the play without scripts and without much prompting. Your task now is to refine the performance until each actor seems to be getting the most out of his part and until the play moves briskly along toward its climax.

The final preparation is called the *dress rehearsal*. Some productions—especially those that have elaborate costumes, may have more than one dress rehearsal. At a dress rehearsal, the actors, wearing their costumes, go through the entire play without interruption. In addition, all scenery and lighting effects are used.



At dress rehearsals, the actors are in costume and go through the entire play without stopping.

Staging the Play

At the time of the performance, the director's task is over. However, in a small production like the one you are likely to be directing, you may also serve as the lighting operator, the prop person, a stagehand, and the prompter. If so, you will be among the busiest people in the theater.

The backstage technical crew, or **stage crew**, is responsible for running the show. In small theater companies, often the same people who build the set and handle the load-in (placing the set on the stage where the play is to be performed, and anchoring it using such methods as bolting frames to the floor) are the ones who change the scenery and handle the curtain during performances.

Directors who are well-prepared have nothing to do when the curtain rises—except to watch the performance, of course.

Designing a Set

Commitment is important to the design process because if you are not committed to doing your best work, your design will be inadequate. It is the designer's responsibility to read through the script and evaluate all the entrances and exits to create a thumbnail sketch. An entrance can be through a door, a window, or a curtain. It could be simply an actor walking on stage. An exit can also be through a door or window, and so on.

You must determine the setting of the play. This will help you design a set that reflects the time and period in which the play is set. Examples might include Victorian, medieval, or perhaps science fiction or futuristic fantasy.

As the designer, you will need to decide if you want an abstract set or a detailed, realistic, extravagant set. An abstract set is not realistic. For example, a ladder might represent a mountain or a tree. A fruit crate could be a rock, a chair, or a bush.

Beware of overloading the set. The audience comes to the theater prepared to use its imagination, so you do not have to show every tree or bush in the forest.

The style of architecture is also an important issue for set design. If the play is set in London, you would not want the architecture to be based on the high-rise buildings of New York City. If the characters in the play are from the poorest neighborhood in a large city, you would not want a design that looks like a middle-class suburb. Sometimes it is a temptation for a designer to create a beautiful picture on the stage without much regard for whether it fits the play. You must resist this temptation.

Another thing to take into account is the season and whether any holidays occur in the script. Keep in mind that each act might need a different type or style of set. You must

The first step in set design is to read the script.

As Shakespeare put it: "The play's the thing." The settings are only one part of the production. The set designer must bear in mind that settings are to be used by actors whose responsibility it is to bring the play to life. The designer can help them do that by creating effective sets, but the designer alone cannot bring the play to life.

also consider the mood of the play. This will help you determine the appropriate colors and textures to use.

A set design should provide an atmosphere in keeping with the play and strengthen the illusion of reality. Nevertheless, it should not be so striking or fascinating that the audience gets lost in it and stops listening to the play.

Planning a Set

If you decide to fulfill requirement 3c by making a model of the set for the play you wrote, you will not have to study the script as closely. However, you will have to think over your design carefully to make sure your set will enhance the play.

portal. A header (or border) and tabs (legs) that can be moved to adjust the size and shape of the proscenium opening to fit various performance needs. It is usually located just up stage of the front curtain and may have provision for mounting lights.

proscenium arch. The framing arch through which, in many theaters, the audience sees the play. Many school auditorium stages have a proscenium arch.

Your first consideration in planning the set is the stage where it will be presented. Is it very wide and shallow? Narrow and deep? Is it a *proscenium* (a stage framed by an arch), or an **arena or central stage** in which the audience surrounds the stage? Is the play to be given outdoors at Scout camp? Clearly, the director and set designer cannot begin to plan settings until they have considered the limits of their stage.

central or arena staging. A theater without a proscenium and usually without curtains. The spectators' seats rise gradually or in tiers, surrounding or nearly surrounding the stage. The stage itself may be a theater floor or a platform or platforms. It may also be called theater-in-the-round. Arena staging is especially good for a play with a small cast in which the action is confined to a small area. It is not so good for the bigger, spectacle-type play in which there is a lot of movement on stage.

At this point you should know the different elements for the initial design. Perhaps trees are necessary, or a kitchen table, a park, a couch, or maybe even a mountain. Perhaps the design needs a focal point around which the action of the play will revolve. In a famous mystery play called *Dial M for Murder*, the audience learns the question of whodunit through a door. In that case, the door would figure prominently in the design.

Using a ruler or an architect's scale and these ideas, start an in-depth draft of your design. State which type of materials you think your set should be made of, such as plywood, fabric, plastic, metal, or maybe plastic foam. Label the objects in your design. For example, if you have a door in your design, you might mark it "a 6-foot plywood door with 2-inch pine molding."

Think of the sight lines from the audience's perspective—what the audience will be able to see on the stage. A set designer has to produce a ground or floor plan, a front elevation, and the sight-line illustrations, which are drawn to scale and in detail.

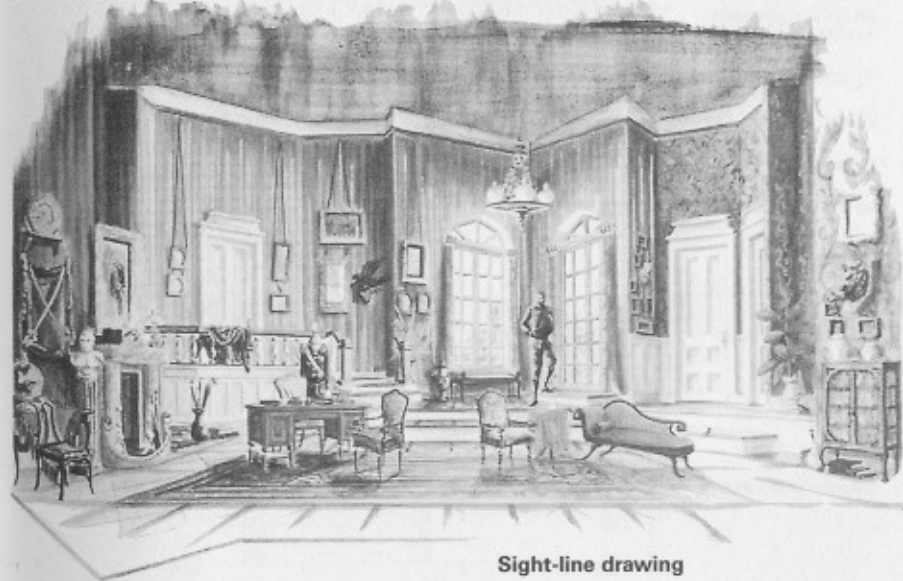

A *sight-line drawing* uses a floor plan like the one you illustrated and a floor plan of the auditorium. You find the farthest extents to which the audience can see, then construct or plan the design around those limits. This not only helps in the set construction but is also a great help to the technical crew.

Another important part of the stage is the **fly loft**, or **flies**. It is the area above the stage, hidden from the audience by a border or drapery, to which scenery can be lifted clear of the stage. Many modern theaters do not have a space above the stage and so are restricted to plays with a single set, minimal settings, or other conventional staging.



Front elevation

A *front elevation design* is done when you take the front view of a set and flatten it into a single plane. This will help people to see the height of the elements that your imagination has created. The *ground plan* is an aerial view of the stage or a floor plan of the set indicating the width of objects used. It must be very precise.

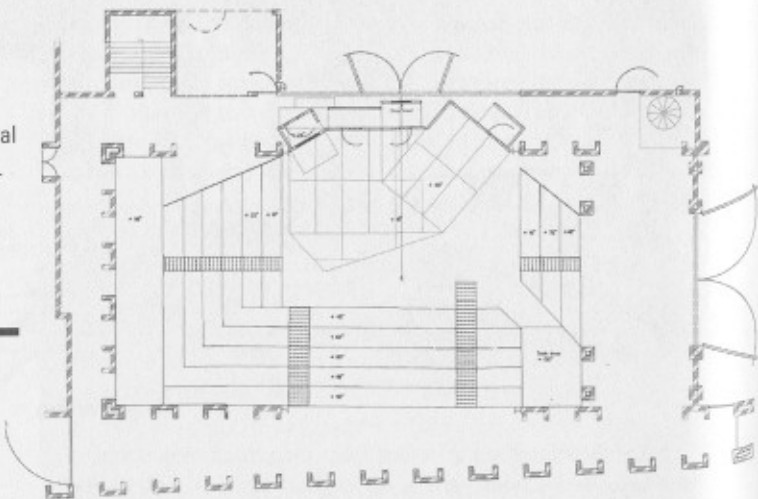

Ground plan

Building a Model

The final step in designing a set is to create a model. The two types of models are the *functional model* and the *production model*.

A functional model is basically a thumbnail sketch put into three dimensions so that a set designer can see if his or her ideas work. A production model is complete in every detail. All of the hand (transportable) props are included in a production model, which is the final product of a designer's imagination.

A 3-foot-wide model is a good working size, but you can build your model set any size you want. For backdrops, use gray cloth. Paint scenery on the cloth if the play calls for it, or simply hang the cloth as a neutral background. For props, consider small toys and doll furniture for your model but remember to consider each character's personality. Are the characters collectors of odds and ends, or do they dislike clutter? These considerations determine the choice of props.

Some set designers use what is called a **cyclorama**, a large composite picture placed or projected on an interior wall of a stage or a cylindrical room. This gives the scene a natural perspective.

Once you have considered the ground plan, front elevation, the sight-line drawing, and the model, you will have everything you need to begin an accurate construction of your set. A lot of research, study, and hard work are necessary to make a truly accurate set design, but the end result will be worth your effort.

cyclorama. 1. A large composite picture placed or projected on the interior walls of a cylindrical room so as to appear in natural perspective to a spectator standing in the center of the room. 2. A large curtain or wall, usually concave, hung or placed at the rear of a stage.

Hand props are things carried on stage or handled on stage by the actors, such as eyeglasses, letters, or a toy six-shooter.

For your first attempt at stage design for a single-set play, you can build a shoe box model. A "shoe box theater" is a suitable and inexpensive way to achieve a good visual of a set.



The backdrop can be made from a stiff piece of coathanger wire and a piece of paper. Use watercolors, crayons, or felt-tip markers to draw the scenery.



Cut the shoe box cover along the lines indicated in the sketch to make a valance or simulated curtain.

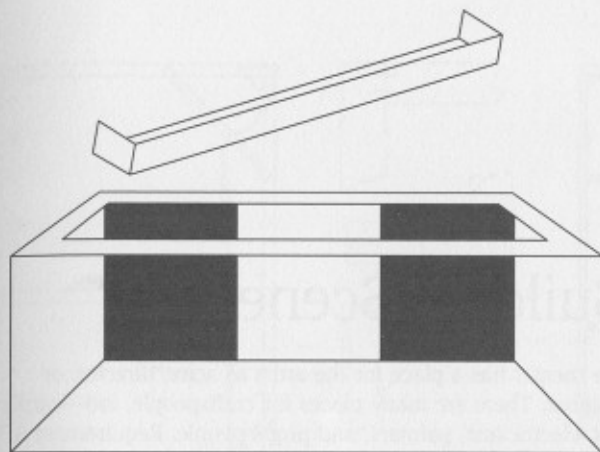
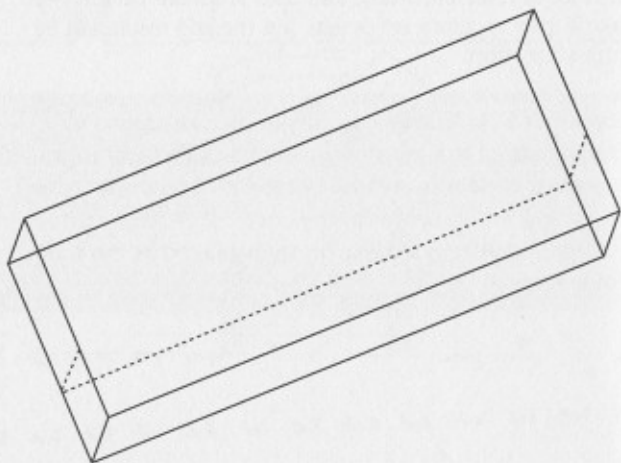

Cut the bottom and one side of the shoe box as shown. The rear opening will admit a light (a flashlight will do). The top opening will allow you to put in a backdrop.

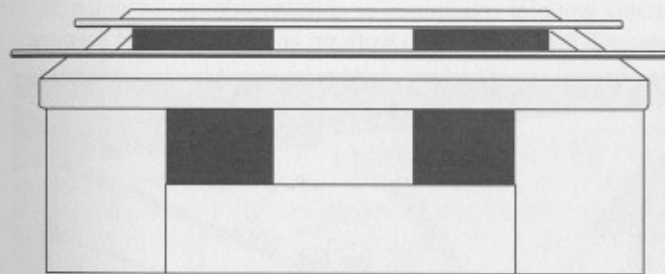

Note the placement of the wires on the top of the shoe box. There should be room for two or three different backdrops.

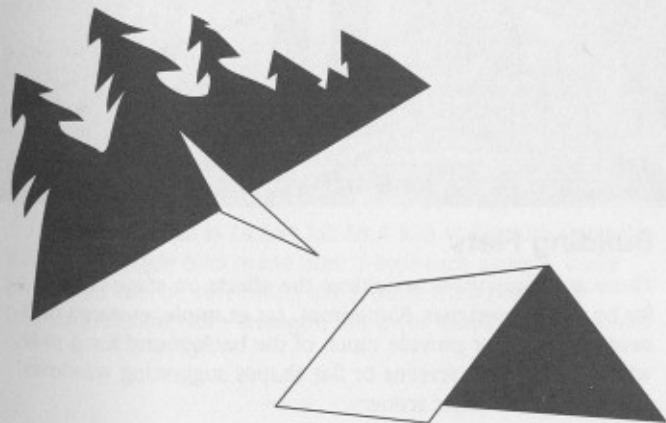

Make small props such as trees and tents from the pieces of cardboard left-over from the shoe box cover.

Building Scenery

The theater has a place for the artist as actor, director, or designer. There are many places for craftspeople, too—carpenters, electricians, painters, and props people. Requirement 3f asks you to try your hand at building scenery for one or two plays. To fulfill this requirement, you will need to join a school drama group or community or children's theater in which you will have a chance to work on and actually build scenery.

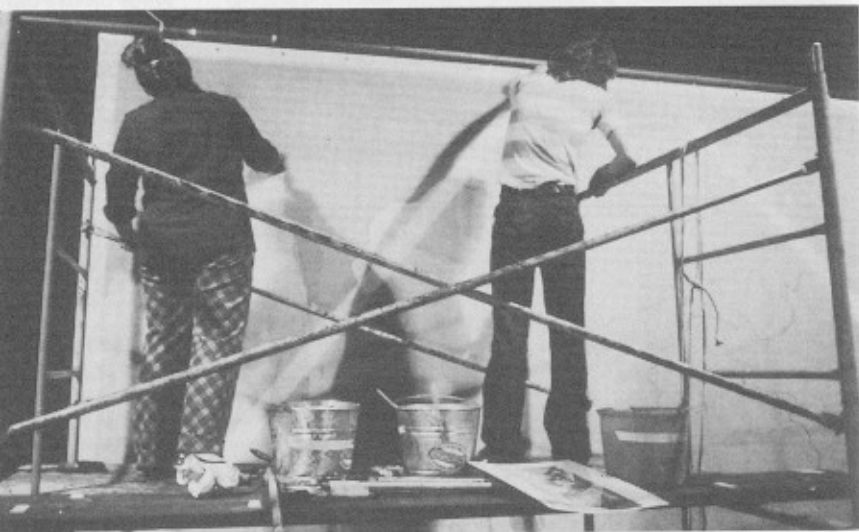

Building Flats

There are many ways to achieve the effects on stage called for by the set designer. Sometimes, for example, curtains of a neutral gray color provide much of the background for a play, with a few folding screens or flat shapes suggesting windows, doors, walls, or other scenery.

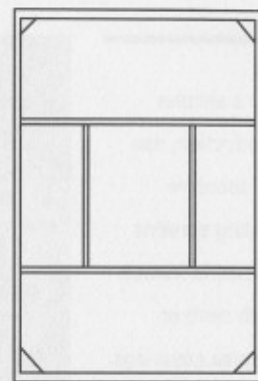
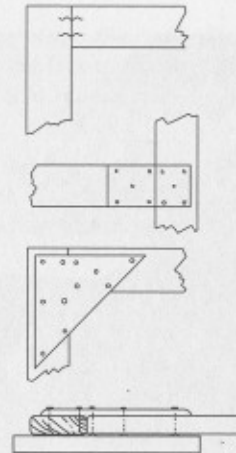
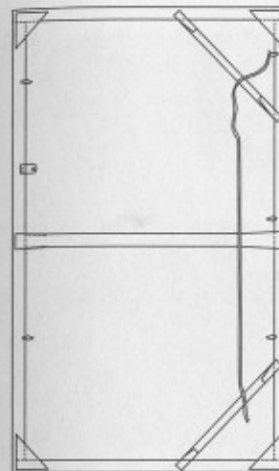

The flat on the left is plain and basic; the flat on the right is designed to include a window. Joints can be reinforced in several ways, as shown by the middle illustration.

When building scenery for a play, you probably will be working mainly with flats. Flats are simply large frames with canvas or another material stretched over them. They are the basic unit of stage scenery. They are made of wood or steel tubing and are normally covered with muslin, plywood, or other fabrics and materials. The flats are painted as walls or windows or whatever the play requires. Flats are lightweight for quick and easy removal and can be used for different plays simply by painting them a different color.

A **stage brace** or rod, hooked to the back of a flat at one end and weighted or screwed down to the floor at the other end, is sometimes used to support a standing flat.

A wooden flat is 14 feet tall by 4 feet wide, with the rails, stiles, and toggle bars made from 1-by-3-inch straight white pine. Flats can be assembled using mortise and tenon or halved joints for extra strength, but most shops use butt joints.

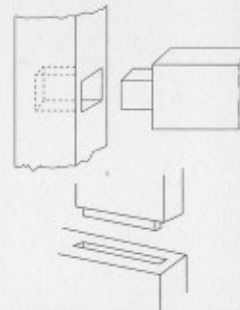

For extra strength, a flat can be assembled using mortise and tenon joints.

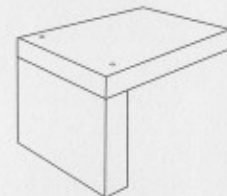

Most flats are assembled using butt joints.

For a simpler production, use inexpensive folding screens or simple frames with cloth or canvas coverings.



When stretching muslin over a frame, avoid stretching it tight; you need to allow room for fabric shrinkage when you paint the muslin.

Putting on the Canvas

For elaborate flats, use heavyweight muslin (128- or 140-thread count). Cut the muslin slightly larger than the height and width of the flat. Stretch the muslin over the frame, but avoid stretching it too tightly—allow room for fabric shrinkage when painting.

Step 1—Using a staple gun or a tack hammer and tacks, attach the muslin along the inside edge of one of the stiles. Place the staples or tacks about a foot apart.



Step 2—Move to the center of the other stile and pull the muslin until it barely sags across the face of the flat. Staple or tack it on the inside edge face of that stile. Be sure that you do not stretch the muslin too tight.

Step 3—Work your way toward the end of the flat, alternately pulling and stapling or tacking the material. Do this in both directions from the tack or staple that you placed in the center of the stile.



Step 4—In a similar fashion, pull and tack the fabric to the inside edge of the face of both rails. If there are any wrinkles or puckers in the fabric, pull the staples or tacks out and restretch the fabric until the fabric lies smooth.

Step 5—Finish covering the flat; glue the muslin to the frame. Regardless of the flat's shape, you should glue the covering only to the face of the rails and stiles. To glue the cloth to the flat, turn the flat of muslin back around the edge of the flat; apply a light coat of glue to the face of the stiles and rails. Use a thorough but light coating because if it soaks through the muslin, the glue may discolor or darken the paint job. Fold the muslin back onto the wood and carefully smooth out any wrinkles with your hand or a small block of wood.



If the covering fabric is not glued to any internal pieces (toggle bars, corner braces), it will be able to shrink evenly when the flat has been painted. This uniform shrinkage will result in fewer wrinkles on the face of the finished flat.

Step 6—After the glue has dried, trim the excess fabric from the flat. The easiest way to do this is to pull the fabric tight and then run a mat knife down the edge of the flat.

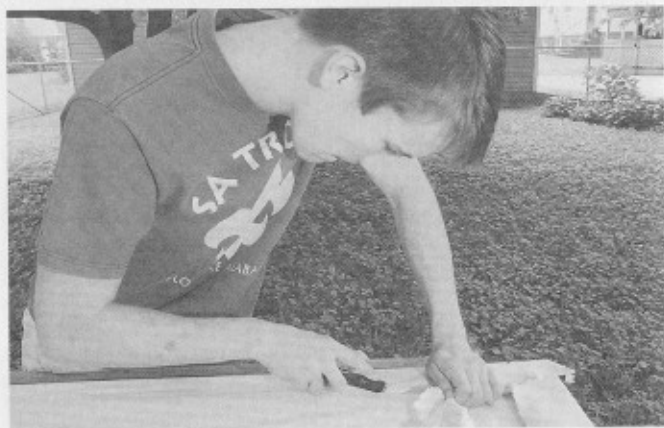

When this process is completed, you have a basic, multipurpose flat. There are many special types of flats for doors and windows that open, as well as such things as stairs and ramps, that you may need to make. For more building tips, read about stage scenery in the books listed at the back of this pamphlet.

Painting Scenery

Painting stage scenery is both an art and a craft. It is a good idea to have someone who is experienced in scene painting show you the ropes. One thing to remember as you begin painting is that the color will be lighter when the paint is dry than when it is wet. For that reason, it is wise before you begin painting to test a little of the paint on a piece of paper or canvas to see how it will actually look when it is dry.

A scene painter needs, at least, shades of yellow, brown, green, blue, red, black, and white. Ordinary housepainter brushes of all sizes are necessary on many projects, but 4-inch brushes are most useful.

The first step in painting a new flat is to prime it, just as you would if you were painting new wood. However, the main purpose of using primer is to tighten the canvas. When the primer has dried, you can begin the real decorating.

Give the project careful thought first. If several flats are to be joined to create a scene (or a wall), be sure that the paint is put on with that end result in mind. Otherwise, painted moldings and wallpaper figures will not match up. Assemble the flats and mark each one in the order it will be used so you can be sure that the moldings of wallpaper pattern will come together properly when the flats are joined.

The actual decorating depends on what your set design requires. If you must mix paints to get an exact shade of color, make sure you keep a sample of that exact color on a piece of paper or in a small can. This way you will not find the set with two different colored pieces that are supposed to be the same.

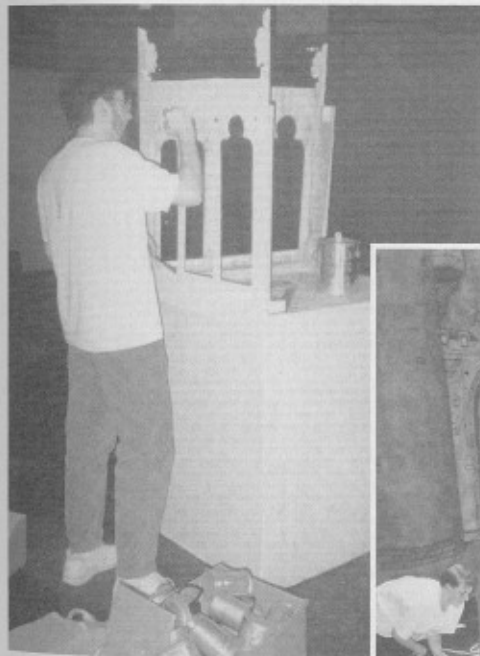

Keep your scene painting bold and simple. If you are not careful, small wallpaper figures will look blurred when viewed from a distance. Make everything straightforward and uncomplicated. In scene painting you are not striving for realism but for an illusion.





Lighting the Stage

Lighting is as important to the production as the actors and the script. Proper lighting techniques are also crucial to follow since you are working with a powerful and dangerous force—electricity. Directors and lighting operators are limited, however, in what they can do by their electrical equipment.

Stage lighting has six functions that must be applied and followed in every lighting project:

Visibility—being able to see what is happening on stage

Mood—the emotions stimulated by the light

Composition—the picture created by the light

Focus—the ability of the light to direct one's attention to a certain part of the stage

Credibility—the necessity of any light to be relevant to the dramatic situation

Unity—the ability of light to tie all other aspects of the show together

Lighting operators achieve these functions by manipulating the *qualities of light*. The qualities of light are

Intensity—the quantity of light and shadow

Direction—the angle at which the light hits the stage

Movement—any change in light that suggests motion

Color—used either in a realistic or highly artificial way, affects moods and attitudes and even perceptions of temperature

Texture—a sense of planned variation in the pattern of lighting

There are two distinct but interrelated areas of stage lighting: the *equipment* that controls and distributes the electricity that creates the light, and the *lighting effects* that are created—that is, the design.

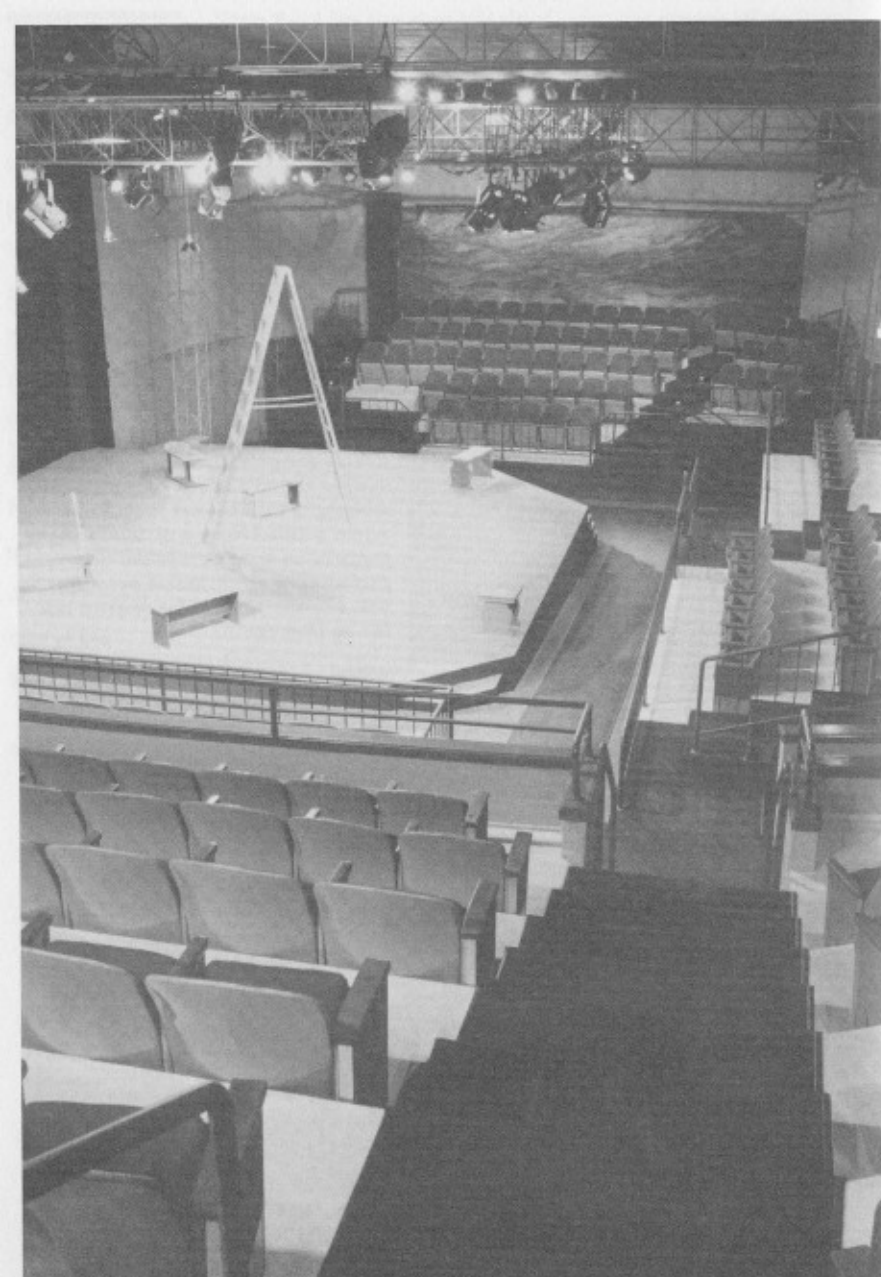

Lights hung from pipes illuminate this thrust stage. *Stage West Productions; photo by Lee Angle Photography Inc.*

Stage Lighting Design

While a technical knowledge of lighting equipment is important, a lighting designer must first be aware of the needs of the play to be lit. The lighting designer must determine how the functions and qualities of stage lighting can best be manipulated for the production at hand.

The beginning designer should develop a sense of nature's own lighting effects in order to make informed yet creative decisions. Spend time examining how moonlight creates shadows and brilliant dappled light. Observe a sunset and try to count the number of colors present and how they change and deepen as night grows closer. Look at the light of a campfire as it reflects off a lake onto the trees. Think about what mood that creates.

With each lighting design it becomes the designer's responsibility to decide which colors, angles, and intensities of light best achieve the appropriate look for each moment of the play. Whether comic or dramatic, most plays take their audience on some sort of emotional journey. The angle of light can make a moment eerie (lit from the side) or produce striking silhouettes (lit from behind).

A "cool" stage (lit with blues, greens, and violets) will help establish calm feelings. A "warm" stage (lit with reds, ambers, and yellows) can intensify moments of excitement or anger.

Lighting plot

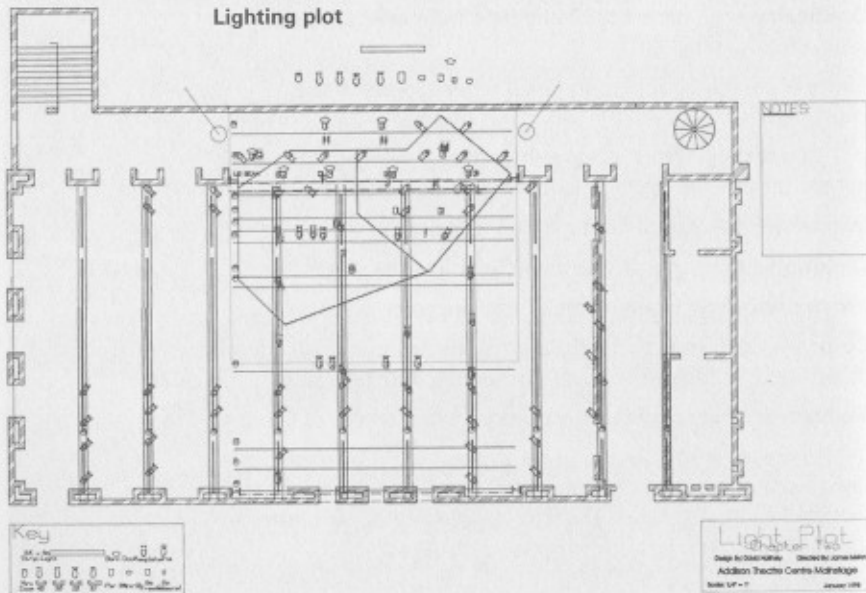

A designer must begin with a thorough knowledge of the play in production. Take notes in the script about the effects needed for each scene and the moods and feelings you think that creative lighting can help convey. Often a designer will sketch moments of the play requiring special attention.

From these sketches and notes, elements of design begin to take shape and the designer will start to draft the layout, or plot, for the design. During the drafting process, more complex technical decisions are made as to the exact type and location of each lighting instrument, electrical circuitry, color, and focus.

Lighting design is best learned through observation and experimentation. If you can't work with real stage lights, make your own instruments using coffee cans and porcelain lamp mountings. Change the color of the beam with colored plastic wrap or pieces of fabric. Professional lighting gel can also be purchased affordably at almost any theatrical shop.

Lighting is among the most innovative of the theatrical arts. New instruments, colors, and techniques are constantly being developed. The design must always serve the entire production, but the ways that can be achieved are endless.

The Hardware

Light for the stage may be provided by an elaborate and extensive assortment of professional lighting instruments, miles of cable, and stacks of dimmers, all designed to meet the needs of the script and performance. However, few school stages are equipped for the kind of lighting effects that can be achieved on a Broadway stage. The lighting for a small production might be achieved through the careful use of a few lightbulbs mounted on coffee cans and controlled by household wall switches. In either situation, an understanding of what the hardware is able to do and how it should be handled for safety and maximum effectiveness is essential.

Many types of lighting equipment are used in the theater. They can be grouped into five main categories:

- Lighting instruments
- Control systems
- Mounting equipment
- Beam modification equipment
- Electrical systems

The following discussion focuses mainly on lighting instruments and mounts—equipment you will need to be familiar with to fulfill requirement 3g.

Around hot lights, be careful not to burn yourself or melt the fabric or plastic you are using for special effects.

Lighting Instruments

border and strip lights. A long, narrow trough that contains several lights in a row is called a border light or strip light. The term *border lights* tends to refer to permanently installed continuous troughs that cross the entire stage. *Strip lights* are usually 6- to 8-foot-long portable sections of lights.



Strip light

ellipsoidal reflector spotlights. Also known as *lekos* or *kleig lights*, these spotlights are the primary lighting instrument in modern theater. These spotlights are used in virtually every location in the theater and for almost every possible purpose of stage lighting.

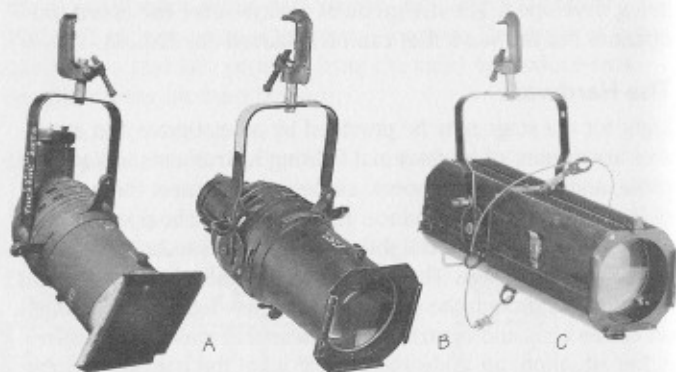

Ellipsoidal reflector spotlights.

(A) Traditional old-generation ellipsoidal; (B) axial ellipsoidal—lamp is on the centerline of the lens and reflector; (C) new-generation ellipsoidal.

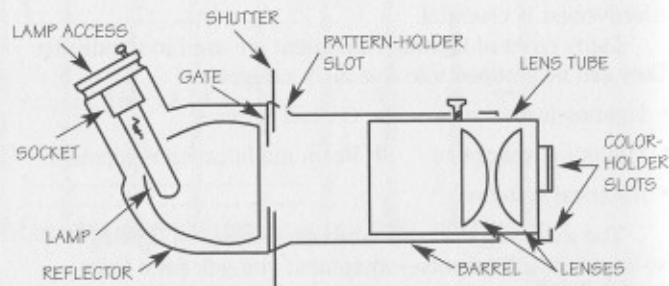

Ellipsoidal reflector spotlight

fresnel. A fresnel (pronounced fray-nul) spotlight produces a soft-edged beam of concentrated illumination. This instrument is distinguished by its lens. If you look at it from the front, you see that the lens has a series of circles carved in it, but from the back, the flat surface is textured. This relatively thin piece of glass creates the effect of a very thick plano-convex lens.



Fresnel lens, side view



6-inch fresnel

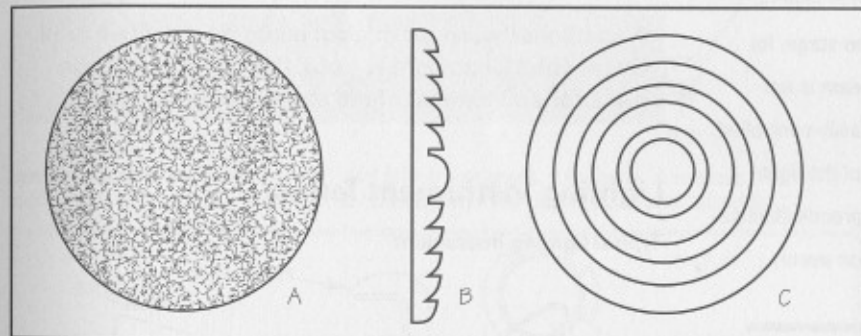

Fresnel lens: (A) back; (B) section; (C) front

PAR can. One of the most practical theatrical lighting instruments available, the PAR can has a simple housing with a yoke, pipe clamp, color holder slot, and socket. The heart of the instrument is the *parabolic aluminized reflector* or PAR lamp, which is mounted at the back of the housing with a spring ring to hold it in place. The modern PAR can provides great flexibility. Just by changing out the lamp, it can project direct light at a specific object or illuminate a particular area. These lamps generally have a long life and are very durable. They will withstand severe shock, and when cool, it is completely safe to touch the glass portion of the lamp.



PAR can

floodlight. A light with a large reflector and a high-wattage lamp that produces a broad fill of light on the stage. Its beam is not easily controlled, but the light spreads illumination evenly.

scoops. Also called ellipsoidal reflector floods (ERFs), scoops are the most common **floodlights** in the modern theater.

spotlights. Spotlights are intended to illuminate a specific area of the stage with a controlled beam of light. Spotlights use plano-convex lenses, which are flat on one side and curved outward on the opposite side.

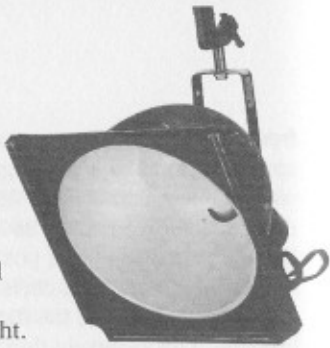

Scoop with rotatable square color-holder slot

A **spotlight** throws an intense beam on a defined area. Often when a spotlight is used, it is focused on a single actor and the rest of the stage is blacked out.

Lighting Instrument Terms

Typical lighting instrument

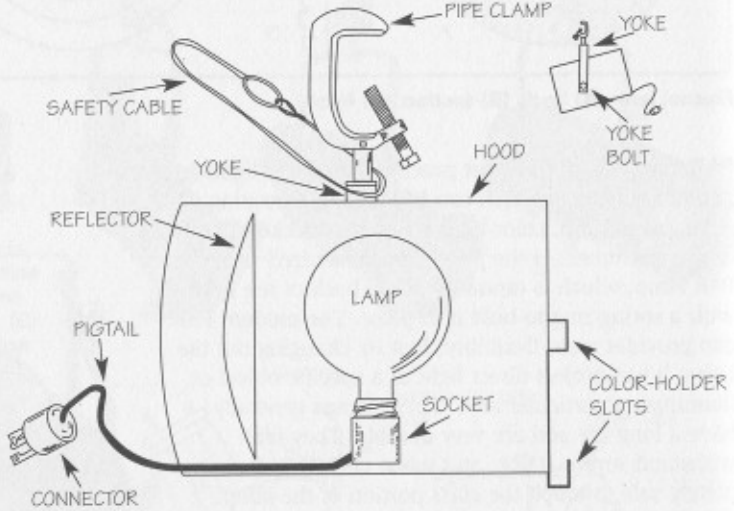

lamps (light bulbs). Designed to fit specific equipment based on the design of the socket, reflector, lens (when used), and overall size of the lighting instrument.

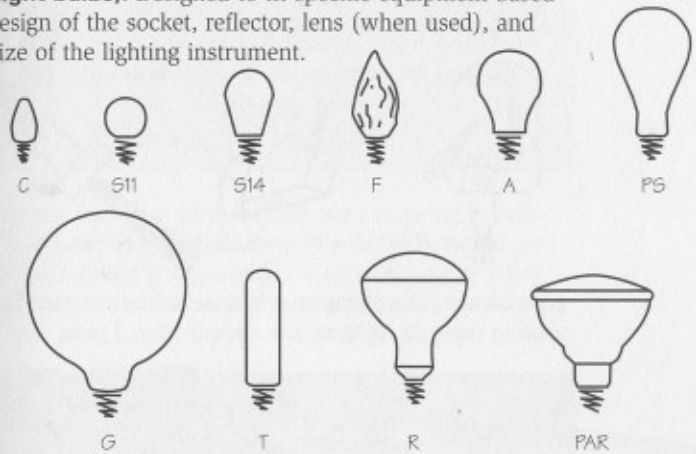

Lamp shapes: C is candelabra, S11 and S14 are spheres, F is flame, A is apple, PS is pear shape, G is globe, T is tube, R is reflector, and PAR is projector and reflector.

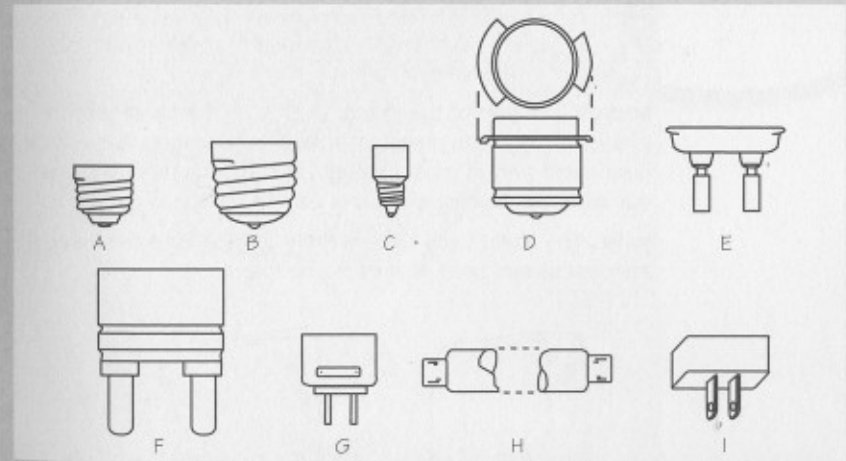

Lamp Bases. As you become familiar with the different styles of lamp shapes you also will learn more about the different types of lamp bases. Here are some of the more typical lamp bases you might see in theater lighting:

- (A) medium screw base; (B) mogul screw base; (C) miniature screw base; (D) mogul prefocus; (E) medium bipost; (F) mogul bipost; (G) medium two pin; (H) double ended; (I) medium end pin.

pigtail. The wire that comes out of the lighting instrument and ends in a plug.

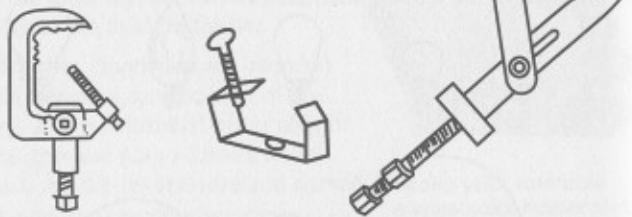

pipe clamp. The clamp that is attached to the yoke by a bolt, used to hang the lighting instrument from a pipe.

safety chains and cables.

Used with all lighting equipment, this extra piece of lightweight cable or chain is wrapped around the pipe from which the lighting instrument is hanging and hung through the yoke.

If the light should start to fall to the stage, the safety cable will catch it.

socket. The part of the fixture that holds the lamp bulb in place and conducts power to it. Although sockets are a fairly permanent part of most lighting instruments, they will wear out with age. Damaged sockets can be replaced.

yoke. The metal band that makes a loop around the lighting instrument and bolts to it on each side.

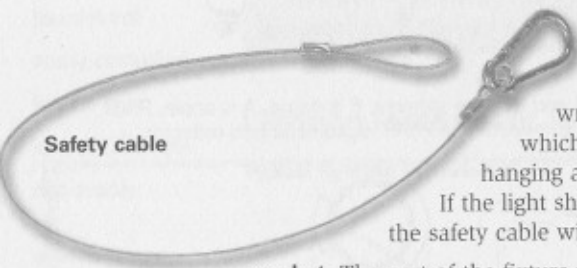

Safety cable

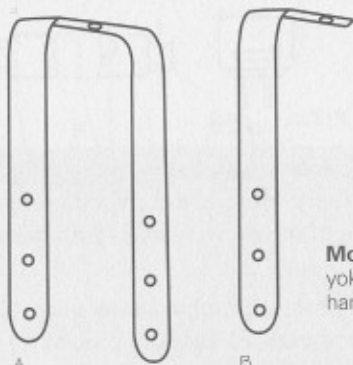

Mounting hardware:
yoke (A) and
hanger iron (B).



Caution: Whenever you are changing lamps on any fixture, always be sure that the circuit is turned off and the light is unplugged. Never touch the glass part of any bulb.

Many combinations of these and other stage lights will be used in a professional production to achieve beautiful results. Stage lighting is impossible to learn without practice. If possible, meet requirement 3g by actually handling the lighting for a play.



Lighting operators control lights using an electronic control board.

Tartuffe
Valere



Designing Costumes

In much the same way that a set designer dresses the stage appropriately, the costume designer enhances a play by dressing the actors appropriately. The first step in costume designing is research. You must read the script and then study the time period in which the play takes place.

For requirement 3d, you are to design five costumes for a play set in any period before the year 1900. Suppose you choose a play that is set in 16th-century England or 19th-century South Africa. Or maybe your play is William Shakespeare's *Antony and Cleopatra*, set in ancient Rome. Or perhaps you choose a play with an American Revolutionary War or Civil War theme. How do you find out how people dressed in those times and places?

If you have access to the Internet, begin your search online (with your parent's permission). The Museum of the City of New York's Costume Collection and the Metropolitan Museum of Art have incredible online resources, whether you are researching the type of hat a Confederate general would have worn or what type of shoes were popular in the Victorian era.

Go to the library and look for costume and history books that show what people wore in the different eras of history and parts of the world. Then, using your imagination, adapt the illustrations found in those books to the characters in your play. Do not just copy some drawings from a book or download another designer's work. Add your own touches, while staying true to the period in which your play is set.





Working closely with the director helps a designer create costumes suited to the play and the era.

Design Sketches

After you have chosen the play and studied its period in history, you need to sketch your ideas for costumes. Preliminary drawings help the costume designer in two ways. First, the sketches are your initial means of visual communication with the director. The director will be able to see how you envision the costumes will look. And secondly, most designers discover through the preliminary sketch process how the costumes will look.

Rarely do costume designers conjure up complete, detailed costumes and represent them on paper. The mind is more apt to visualize bits and pieces that reveal character types. You may decide, for example, that the sleeves should be long and flowing; you may know that the skirt must trail on the ground. However, it is only when you begin sketching that the individual ideas and images come together into a design.

A color sample swatch done in watercolor shows the palette of colors the designer has chosen for a character's costumes.



Start sketching before you have everything in your mind in complete detail. You will find that as you sketch you will start to design.



Preliminary pencil sketches

Much Ado About Nothing



-Beatrice
#4

Kathleen J. Minns
Oak Spring, 1995

Much Ado About Nothing



-Claudio
#3

Much Ado About Nothing



-Beatrice
look 2



Beatrice

John G. Jones,
Oak Spring, 1995

Fabric swatches help complete the design.

After doing some research and studying the script, you can start to sketch simple drawings that reflect how you think the characters should look. Add swatches (pieces) of fabric to your design with notes to indicate what fabrics will be used for what purpose. Once you have satisfactory preliminary sketches, use colored pencils or colored artists' chalk to give your designs the colors, textures, and patterns you want to portray.

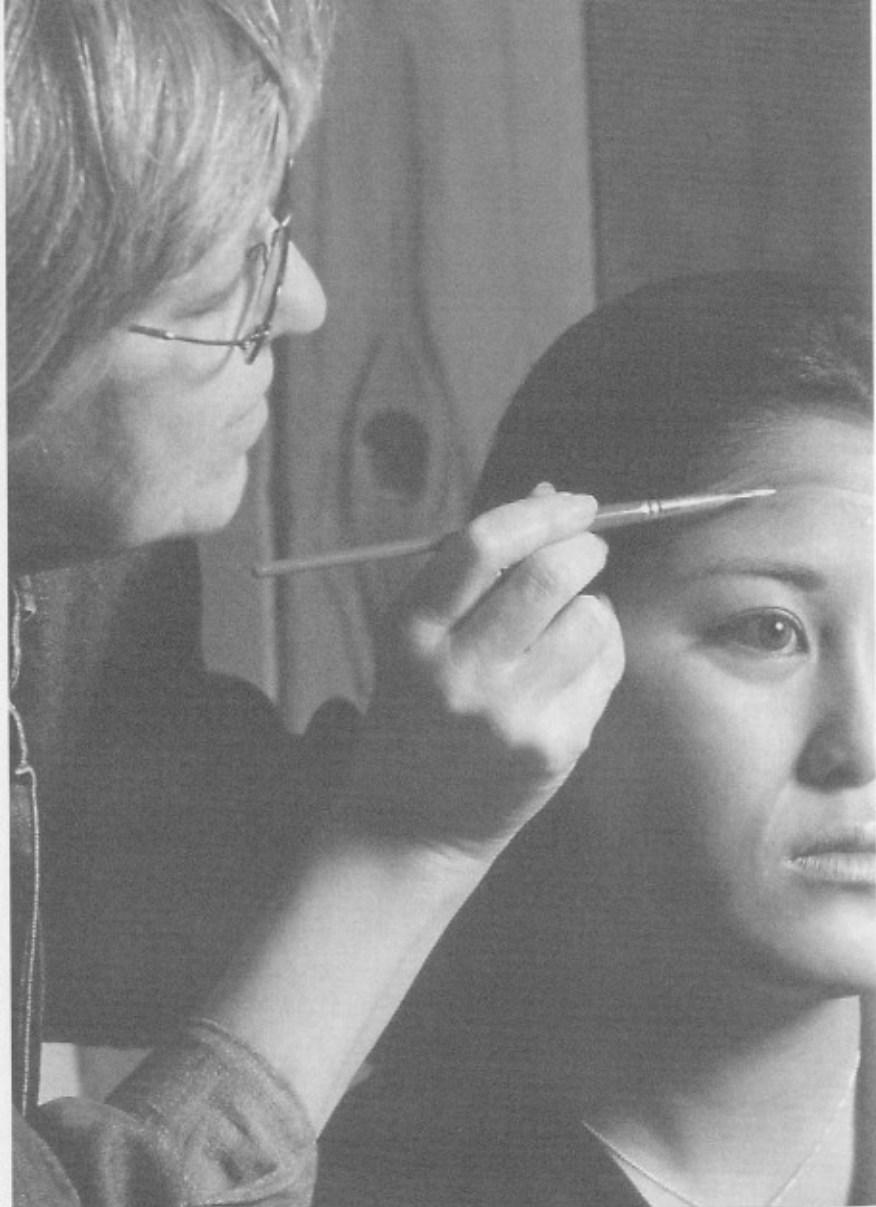

Using Stage Makeup

Remember when you were a small boy and you wanted to play pirates? You may have borrowed your mom's red lipstick to draw jagged red scars on your cheeks and arms to give yourself that authentic pirate look.

Requirement 3e calls for you to show real skill in applying stage make-up. If you have ever seen a theatrical play or circus and glimpsed the actors or performers after the lights go down but before they remove their stage makeup, you may be shocked to see just how much they are wearing. Under stage lights and from a distance, stage makeup dramatically heightens the "presence" of an actor or actress. Up close without the lights and illusion of theater, these same actors may look like garish Mardi Gras figures.



As you become skilled at applying makeup, you will find it easy and fun to make up yourself or a friend as almost any character, from a clown to a patch-eyed pirate to Abraham Lincoln. Try many characters. Requirement 3e asks you to apply makeup to yourself or a friend as one of four characters, but you will enjoy trying many other characterizations. You can also use whiteface makeup when you perform as a mime. Check out books on mime and stage makeup at your local library to learn specific techniques for various characters.

Purposes of Makeup

In the theater, makeup has several purposes.

- It adds to the actor's characterization of his role. If he is playing an old man, he ought to look like an old man to the audience.
- It is easier for the other actors to play their parts properly because they are reacting to the old man, not to the guy down the street who attends the same school they do.
- It helps the audience see the actors clearly. The bright stage lighting tends to wash out an actor's face unless his features are emphasized by makeup.



Makeup Equipment

To do a proper job of makeup, you need a kit with some basic items. These can be fairly expensive, so borrow a kit if you can. Perhaps the school drama department or the community theater has one you can borrow. Most of the materials can be bought at a discount store, but the cost will be high if you must buy everything yourself.

Basic Makeup Kit

Here is what you need for a basic makeup kit.

- Cold cream or liquid makeup remover
- Foundation or greasepaint in assorted colors
- Crème and dry rouge in assorted colors, rouge brush
- Lipsticks in assorted colors, lip brush
- Eye shadows, eye shadow brushes
- Face powder in assorted colors
- Silk sponge, powder puff, powder brush
- Eyeliners (blue, gray, maroon), eyeliner brush
- Nose putty
- Spirit gum, spirit gum remover
- Crepe hair in assorted colors (including your own hair color)
- Scissors, comb, hand mirror
- Absorbent cotton, tissues

Using all this equipment requires much practice and a steady hand to achieve the effects you want. Ask your counselor or someone else in your community who is knowledgeable about theater for advice on making up.

Making Up

Here are a few tips that may be useful as you make up as an old man, a clown, an extraterrestrial, or a monster should you choose requirement 3e.

- The face should be absolutely clean before you begin applying makeup.
- Apply foundation or greasepaint first. It gives the proper color and base.
- To give a monster or an extraterrestrial some grotesque bumps, use nose putty, which is soft plastic material that sticks best to dry skin. Put it on before applying foundation or greasepaint.
- To make a clown's rubber ball nose, use a ball, cutting it to fit over your nose. Stick it in place with adhesive tape and spirit gum. Blend foundation or greasepaint to cover the edge.
- To make a young, healthy person look old or sick, lighten the lips and cheeks. Using eye shadow, darken the area around the eyes and put lowlights in the cheeks to make them look old and shrunken.
- To give yourself a bald head, use a tight-fitting bathing cap with slits cut for your ears.
- To put scars on a monster, draw them with dark lipstick or black liner and powder them.

To remove makeup, rub your face with cold cream or liquid makeup remover until the makeup is dissolved. Around your eyes use only eye makeup remover—never petroleum jelly, baby oil, or anything other than remover intended for eye makeup, as this could cause an infection around your eyes. Then wipe your face with tissues until all the grease is off. Wash thoroughly with soap and warm water.

With makeup, you can turn anyone into Frankenstein. All you need is a lot of practice.

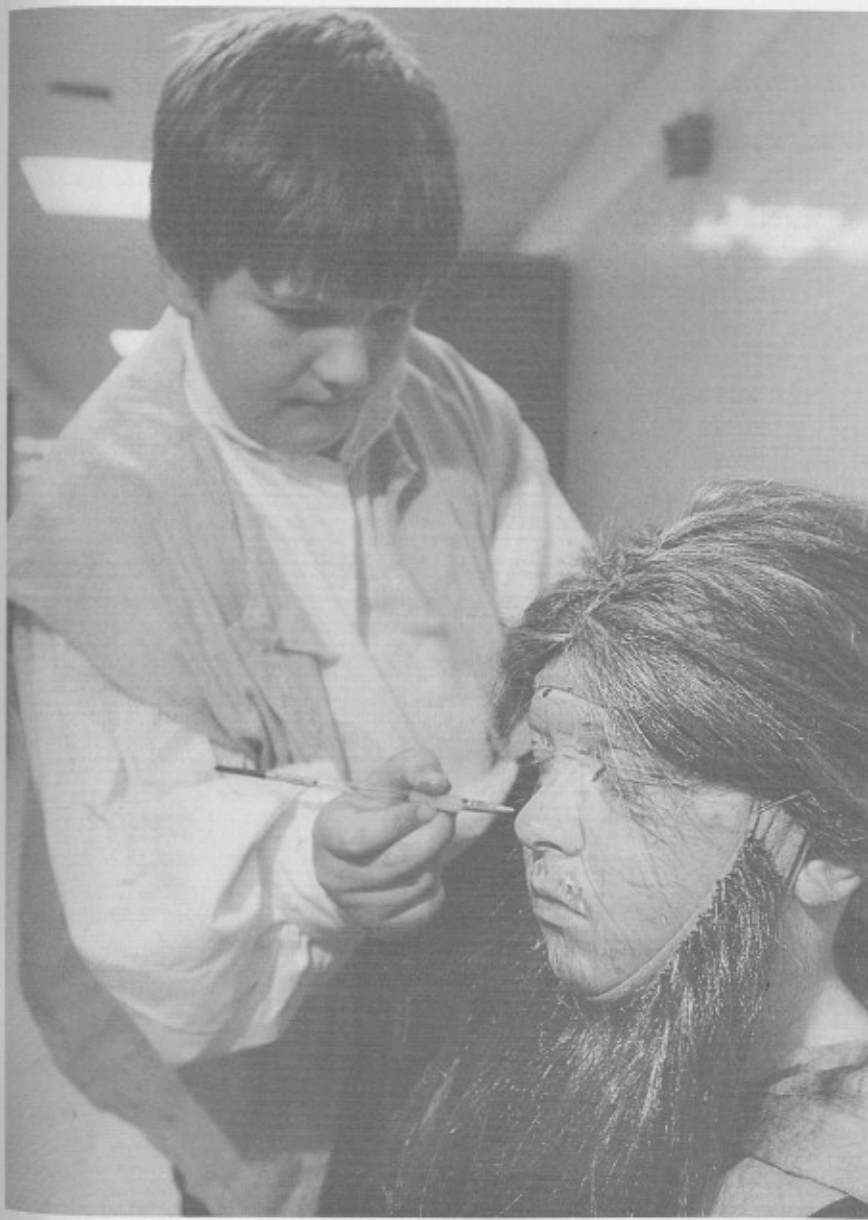

To make yourself look older, frown and wrinkle your forehead. With eye shadow, mark in the wrinkles.



What's Next?

When you have earned the Theater merit badge, you will have mastered some of the basics of work in drama. You can learn much more about the intricacies of theater in special schools and workshops.

One excellent way to learn more is to join a children's or community theater troupe. Search out these opportunities and offer your services. You may be given such unglamorous work as painting scenery or ushering patrons to their seats before performances. But you will learn something every time you step inside the theater, not to mention having fun and gaining valuable experience.

Study the great plays at your public library. Search out plays on film at both your library and local video store.

As the curtain falls on this merit badge, another curtain is rising somewhere in your world. Get involved in theater. Act in a Scout skit. Volunteer for school plays. Join a theater group. Read and watch plays. Scouting stresses learning by doing. So, too, does the theater.

