

MERIT BADGE SERIES

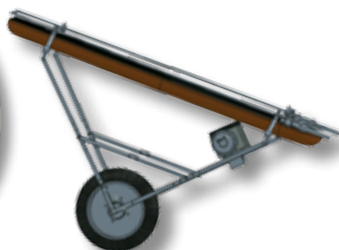

INVENTING



BOY SCOUTS OF AMERICA®



HOW TO USE THIS PAMPHLET

The secret to successfully earning a merit badge is for you to use both the pamphlet and the suggestions of your counselor.

Your counselor can be as important to you as a coach is to an athlete. Use all of the resources your counselor can make available to you. This may be the best chance you will have to learn about this particular subject. Make it count.

If you or your counselor feels that any information in this pamphlet is incorrect, please let us know. Please state your source of information.

Merit badge pamphlets are reprinted annually and requirements updated regularly. Your suggestions for improvement are welcome.

Send comments along with a brief statement about yourself to Youth Development, S209 • Boy Scouts of America • 1325 West Walnut Hill Lane • P.O. Box 152079 • Irving, TX 75015-2079.

WHO PAYS FOR THIS PAMPHLET?

This merit badge pamphlet is one in a series of more than 100 covering all kinds of hobby and career subjects. It is made available for you to buy as a service of the national and local councils, Boy Scouts of America. The costs of the development, writing, and editing of the merit badge pamphlets are paid for by the Boy Scouts of America in order to bring you the best book at a reasonable price.



BOY SCOUTS OF AMERICA
MERIT BADGE SERIES

INVENTING



LEMELSON-MIT PROGRAM

celebrating innovation, inspiring youth

The Inventing merit badge and pamphlet were made possible in part by the Lemelson-MIT Program.



BOY SCOUTS OF AMERICA®

Note to the Counselor

While the scope of inventing projects is far too wide to cover here, there are some general guidelines and concerns that a merit badge counselor should keep in mind. Be mindful of managing risk and using good judgment when undertaking any invention project. Remember, an injury that doesn't happen needs no treatment; an emergency that doesn't occur requires no response.

See the *Composite Materials, Home Repairs, Woodwork, Emergency Preparedness, and First Aid* merit badge pamphlets for more information about safety, first aid, and managing risk.

Safety is the top priority, so a Scout who is working on his invention should follow safety precautions whenever using tools, equipment, and other materials. In a workshop setting, use the buddy system. Be sure Scouts know they should always work under the supervision of a responsible adult who is knowledgeable about the tools, equipment, and materials they plan to use.

Working on inventions can take place in home workshops, in school shops, or even in community shops. When working outside of the home, be sure to familiarize Scouts with the safety requirements of the shop. Some shops require a basic safety class or will have minimum age requirements to use equipment like a lathe or milling machine.

Here are some basic rules to follow:

- Use the proper personal protective equipment, including body, hand, ear (such as protective foam ear plugs), eye-face protection (such as safety glasses with side shields), closed-toe shoes, and foot coverings.
- Use protective clothing whenever necessary to prevent exposure to hands, eyes, and face, and to keep hazardous materials from contaminating street clothes.

- Be trained on any equipment you plan to use *before* you get started.
- If fine particles in the air are anticipated—even in a well-ventilated area—be sure to have the proper respiratory equipment on hand for protection from dust, exhaust and fumes.
- Never tolerate horseplay when using tools.
- Stay an arm’s length away from others using tools or equipment.
- Know where the “off” switch is before turning on a power tool.
- Clean up the area every time work is finished and return all tools to their proper location.
- Have a first-aid kit and fire extinguisher on hand.
- *Ask questions*; never assume or guess!



Wear close-fitting clothing. Loose or baggy clothing can easily get caught in machinery.

Requirements



1. In your own words, define *inventing*. Then do the following:
 - a. Explain to your merit badge counselor the role of inventors and their inventions in the economic development of the United States.
 - b. List three inventions and state how they have helped humankind.
2. Do ONE of the following:
 - a. Identify and interview with a buddy (and with your parent's permission and merit badge counselor's approval) an individual in your community who has invented a useful item. Report what you learned to your counselor.
 - b. Read about three inventors. Select the one you find most interesting and tell your counselor what you learned.
3. Do EACH of the following:
 - a. Define the term *intellectual property*. Explain which government agencies oversee the protection of intellectual property, the types of intellectual property that can be protected, how such property is protected, and why protection is necessary.
 - b. Explain the components of a patent and the different types of patents available.
 - c. Examine your Scouting gear and find a patent number on a camping item you have used. With your parent's permission, use the Internet to find out more about that patent. Compare the finished item with the claims and drawings in the patent. Report what you learned to your counselor.
 - d. Explain to your counselor the term *patent infringement*.
4. Discuss with your counselor the types of inventions that are appropriate to share with others, and explain why. Tell your counselor about one nonpatented or noncopyrighted invention and its impact on society.

5. Choose a commercially available product that you have used on an overnight camping trip with your troop. Make recommendations for improving the product, and make a sketch that shows your recommendations. Discuss your recommendations with your counselor.
6. Think of an item you would like to invent that would solve a problem for your family, troop, chartered organization, community, or a special-interest group. Then do EACH of the following, while keeping a notebook to record your progress.
 - a. Talk to potential users of your invention and determine their needs. Then, based on what you have learned, write a statement describing the invention and how it would help solve a problem. This statement should include a detailed sketch of the invention.
 - b. Create a model of the invention using clay, cardboard, or any other readily available material. List the materials necessary to build a prototype of the invention.
 - c. Share the idea and the model with your counselor and potential users of your invention. Record their feedback in your notebook.
7. Build a working prototype of the item you invented for requirement 6*. Test and evaluate the invention. Among the aspects to consider in your evaluation are cost, usefulness, marketability, appearance, and function. Describe how your original vision and expectations for your invention are similar or dissimilar to the prototype you built. Have your counselor evaluate and critique your prototype.

*Before you begin building the prototype, you must have your counselor's approval, based on the design and building plans you have already shared.
8. Do ONE of the following:
 - a. Participate with a club or team (robotics team, science club, or engineering club) that builds a useful item. Share your experience with your counselor.
 - b. Visit a museum or exhibit dedicated to an inventor or invention, and create a presentation of your visit to share with a group such as your troop or patrol.
9. Discuss with your counselor the diverse skills, education, training, and experience it takes to be an inventor. Discuss how you can prepare yourself to be creative and inventive to solve problems at home, in school, and in your community. Discuss three career fields that might utilize the skills of an inventor.



Contents

What Is Inventing?	9
History of Inventing.	13
Impact of Inventing on Humankind	19
Inventors in the Community	25
Intellectual Property, Patents, and Trademarks	37
Inventing Closer to Home	49
The Inventing Process	57
Building the Prototype.	71
Community Resources for Inventors.	79
Inventing As a Career	87
Glossary	91
Inventing Resources.	94



What Is Inventing?

Inventing is the process of finding *technological solutions* to real-world problems.

Italicized terms such as *inventing*, *engineering*, *entrepreneurship*, and *innovation* can be found in the glossary toward the end of this pamphlet.

The Spirit of Inventing

The spirit of inventing involves a combination of experimentation, investigation, inquisitiveness, and creative thinking. Inventing is an exciting journey of discovery, often yielding mixed or unexpected results along the way. In a sense, inventing is described by the phrase “thinking outside the box.”

By learning about inventors and the way they think, you will begin to understand the importance of developing skills and approaches to thinking that are essential for the process of inventing. You have probably heard of McCormick, Ford, and the Wright Brothers, but what about Leatherman, Ball, Dietrich, or Amarasiriwardena? They are all modern or contemporary inventors. As you work toward your Inventing merit badge, you will discover that it is never too early to begin your own journey toward inventing.

Inventing Defined

To invent is to create something new that is useful or helpful, by means of your own investigation, experimentation, and thinking.

Inventors are
curious about
the world
around them.

Inventiveness is a form of creative problem solving, resulting in an invention.

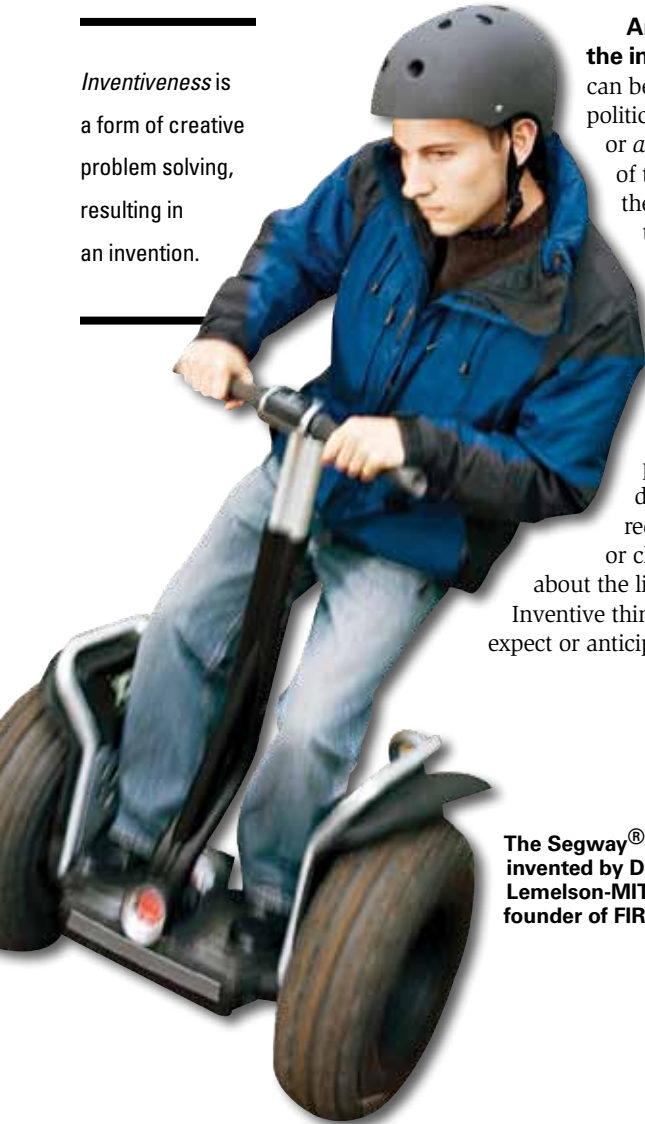

An invention is the product of the inventing process. Inventions can be devices, machines, materials, political systems, processes, or *algorithms*. For the purpose of the Inventing merit badge, the word *invention* will refer to something physical that did not exist and is made possible by technology.

How is inventing different from *routine problem solving*? Inventing crosses the boundaries of the way things have been done in the past. It ties together academic disciplines in unexpected ways, redefines the problem itself, or challenges long-held beliefs about the limits of what is possible. Inventive thinking challenges what we expect or anticipate.

The Segway® Personal Transporter was invented by Dean Kamen, the \$500,000 Lemelson-MIT Prize winner in 2002 and founder of FIRST Robotics.

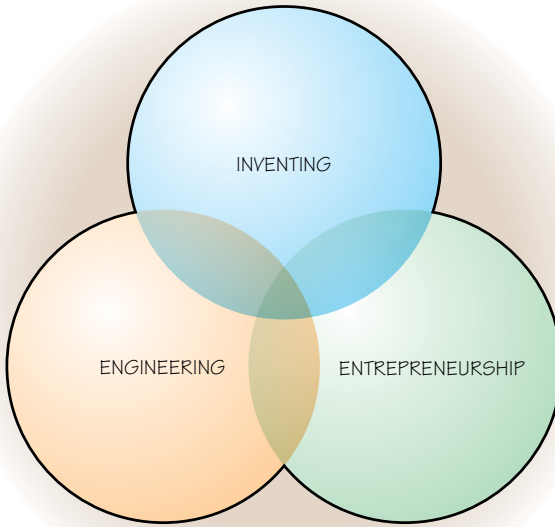

An invention is
useful and unique,
and it has to work.

The sphere of innovation

Macroinventions, like the integrated circuit, make a big impact and change the way we live. Macroinventions bring about invention improvements, known as *microinventions*. For example, the integrated circuit made consumer electronics possible.

Innovation is not the same as invention, although sometimes the two terms are used interchangeably. Innovation is the entire process of **developing and introducing new ideas into use**. An invention is noteworthy when it leads to widespread use. In other words, society benefits from the invention, **after** innovation. *Inventing*, *engineering*, and *entrepreneurship* are all part of *innovation*.



History of Inventing

Although it might be said that human beings are inventive creatures, until recent times invention was limited, sporadic, and not always long-lasting. The scientific revolution (1520–1750) and the first industrial revolution (1760–1850) laid the foundation for an outpouring of sustainable inventions.

The second industrial revolution, which began in the late 1860s, after the Civil War, brought about a period of accelerated inventive activity into the early 1900s. This led to dramatic changes in our society as we transitioned from an agriculturally based market to a manufacturing-oriented economy. Our economic system is now knowledge-centered. Along the way, inventions have improved living conditions for countless people around the world.

The Boy Scouts' involvement in inventing goes back to the early 20th century at the height of the second industrial revolution. In 1910, the Boy Scouts of America was founded to “cultivate courage, loyalty, patriotism, brotherliness, self-control, courtesy, kindness to animals, usefulness, cheerfulness, cleanliness, thrift, purity, and honor” in boys. That same year, boys were introduced to the fictional boy inventor Tom Swift. A series of books about Tom portrayed him as a natural inventor with an American entrepreneurial spirit. By testing, tinkering, building, and experimenting, Tom created his own inventions, including an airship, photo telephone, and a Taser-like device he called an electric rifle.

Like Tom Swift, many Boy Scouts were experimenting with inventions of their own as they worked toward the Invention merit badge. As the 1911 *Boy Scouts of America Handbook for Boys* states, “To obtain a merit badge for Invention a Scout must: 1) Invent and patent some useful article; and 2) Show a

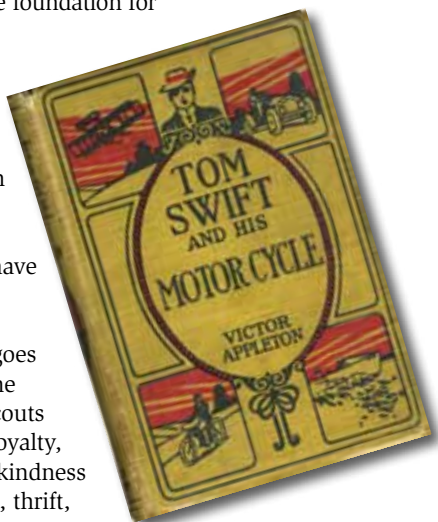

The first Tom Swift book was published in 1910.



The Invention merit badge, circa 1911

working drawing or model of the same.” With such stringent requirements, only 10 Invention merit badges were ever earned, and the badge was discontinued in 1915. But the ideas of invention and innovation—finding new solutions to problems, understanding new technologies, learning new skills, and thinking in new ways—were prevalent in other Boy Scout activities and throughout America during the decade of 1910–1920.

In 1913, Henry Ford adopted the assembly line manufacturing process, revolutionizing the automobile industry. By 1915, the millionth Model T had rolled off the assembly line. At an average cost of about \$500 each, cars became affordable for the first time for many American families. The widespread availability of cars created the need for a range of innovations: new road systems, laws, service stations, and repair shops. Boy Scouts were earning the Automobiling merit badge, which required them to obtain their driver’s license, and understand the functions of various automobile parts, including the clutch, carburetor, and spark plugs.



The Automobiling merit badge, circa 1911

In 1911, electricity was changing American family life. Through early 20th century innovations, electricity was becoming more accessible to Americans, especially in urban areas. Electricity in homes meant consistent and reliable lighting, heating, and eventually, appliances like toasters and electric ovens. In 1911, Boy Scouts could earn an Electricity merit badge by making an electromagnet, repairing broken electric connections, and knowing how to resuscitate someone who received an electric shock.

W. C. Coleman founded the Coleman Company.

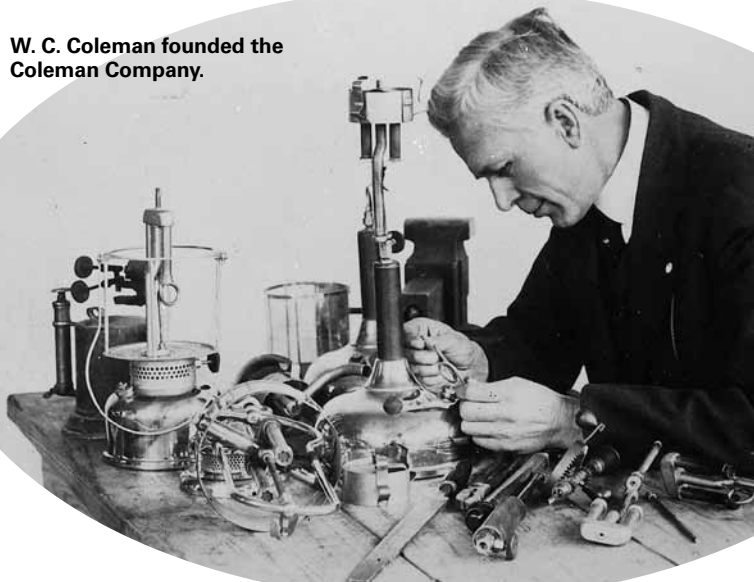

The W. C. Coleman Story: Seeing the Light

Back in 1900, W. C. Coleman had a couple of problems. He couldn't see very well, and he was running low on money to finish his last year of law school. His two problems had absolutely nothing to do with each other, but the solution did. He saw an extremely bright lamp in a store window. When he inquired about the lamp, he found that it had a mantle instead of a wick, and it used pressurized gasoline for fuel. The bright light made it possible for him to read even small print. He became a salesman for the lamps.

W. C. Coleman used the money he had earned as a salesman to buy the inventory of lamps—and the patents—that produced the bright light. This was before electricity was available in rural areas. In 1914, when the original Invention merit badge was still being offered, W. C. Coleman introduced the lantern that made his company famous for making life more productive for farmers, ranchers, and shop owners, who could stay open after dark.

Even after electricity became available in rural areas, the Coleman Company continued to grow because its employees continued to look for problems to solve. As automobiles became more common, the Coleman Company introduced the camp stove for car travel.

The GI Pocket Stove was a valuable contribution during World War II, as it provided heat for cooking and warmth. In 1954, the company introduced the steel cooler. The plastic cooler followed just a few years later.

Today, the Coleman Company sells hundreds of products focused on outdoor interests. What Boy Scout hasn't used a Coleman® product?

A mantle is a lacy hood that helps illuminate light.

Inventions today, just like 100 years ago, help make life healthier, more comfortable, more informed, more engaging, and more productive.

When the United States entered World War I in 1917, many citizens—including Boy Scouts—supported the war effort in creative ways. Scouts sold more than \$147 million worth of Liberty Bonds to raise money for the war, distributed more than 300 million pieces of government literature, and planted wartime victory gardens to ease reliance on the public supply of fruits and vegetables.

World War I brought advances in radio technology that allowed sailors to communicate with other ships and with Navy stations on land. While Americans did not yet have radios in their homes, many people, especially boys, built their own radios and experimented with what were called *crystal sets*. To find a radio signal, boys could touch a wire called a “cat’s whisker” to a crystal rock fixed into a cup.

Crystal sets allowed boys to listen with headphones to radio signals, but not send any. These radio systems were called “wireless.” The first-ever radio broadcast occurred on December 24, 1906, with Reginald Fessenden playing a recording of Handel’s “Largo,” and then playing “O Holy Night” on the violin, and singing along. This was the first public broadcast of the human voice and music. It marked the transition from wireless telegraphy, or Morse code, to true radio. The first radio news broadcast followed in November 1920.

During the 1920s, radio blossomed, bringing music, news, and new ideas into American homes. Other technologies also developed: airplanes, movies, and refrigerators changed the ways Americans lived. The nation changed, and so did the Boy Scouts, introducing merit badges to help boys explore and master new technologies, and to help them become “efficient leader[s] in the paths of civilization and peace.”



While we don't know the names of the 10 Scouts who earned the first Invention merit badges, nor do we know what they invented, we do know that they were living in a technologically exciting time. Today is just as exciting. We are not inventing airplanes just to fly in the air or automobiles just to drive on roads, but rather we are inventing airplanes that can be both flown and driven. Inventors are developing ways to target tumor cells with gold *nanoparticles* to treat cancer, with fewer side effects. Cell phones are being used to collect health care data so the quality of life can be improved in developing countries like Kenya.



The Aviation merit badge, circa 1911

What will Boy Scouts who earn the Inventing merit badge invent?



The Transition roadable aircraft is a plane that can fold its wings and be driven along the road like a car.



Impact of Inventing on Humankind

The impact of inventing on humankind is inestimable. Not only have inventions improved the quality of life for countless people around the world, they have also changed the course of history and the foundations of modern society. Technology has become such a large part of our daily lives that we cannot imagine surviving without the conveniences it has brought to us. Imagine living without your cell phone. Texting would not exist, and to make phone calls you would have to use a landline.

The changes our society has experienced in moving from an agriculturally based market to a manufacturing-oriented economy and now to a knowledge-centered economic system have created fertile ground for Boy Scouts to devise ingenious solutions to a wide range of problems to help humankind. There are countless opportunities for new products and services that take advantage of high-speed worldwide communications and transportation. We live in an exciting time with a global environment for knowledge sharing and distance learning, both of which foster opportunities for working together to develop solutions.

Recounting all of the inventions that have impacted humankind could fill a library. Let's look at three "historical" inventors and their inventions to see how they changed our world.

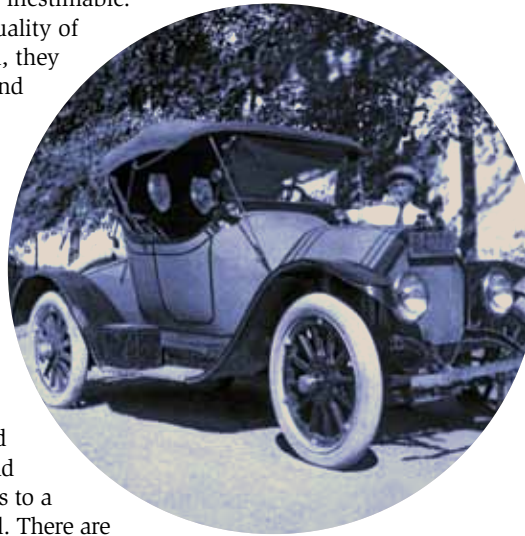

Cyrus McCormick (1809–1884)

Cyrus McCormick is called the “father of modern agriculture” because he invented the first successful mechanical reaper in 1831 when he was 22 years old. With his reaper, McCormick single-handedly increased the potential yield of farming at least tenfold, with a minimum of effort by farmers. The reaper was the beginning of a new mechanical harvesting industry that made significant contributions to the prosperity of Americans.

Cyrus had a talent for agriculture and invention at an early age. When he was 15, he invented a lightweight cradle for carting harvested grain. The mechanical reaper was actually a project on which his father, also an inventor, had given up. Cyrus used his father’s incomplete model as a starting point. He sketched plans for a machine that would automatically cut, thresh, and bundle grain while being pulled through a field by horses. Within six weeks—before the 1831 harvest was over—he had built, field-tested, remodeled, and successfully demonstrated to the public the world’s first mechanical reaper.

Farmers were initially uninterested in the mechanical reaper, and for nine years there were virtually no sales, probably because farmers were reluctant to change what they knew. Undaunted, McCormick spent 10 years making improvements and was awarded his first patent in 1834. He also utilized novel business practices, including lenient credit for purchases, written performance guarantees (“15 acres a day”), readily available replacement parts, and advertising to educate farming communities about the benefits of technology.



Cyrus McCormick invented the mechanical reaper, which resulted in a revolutionary breakthrough in agriculture.

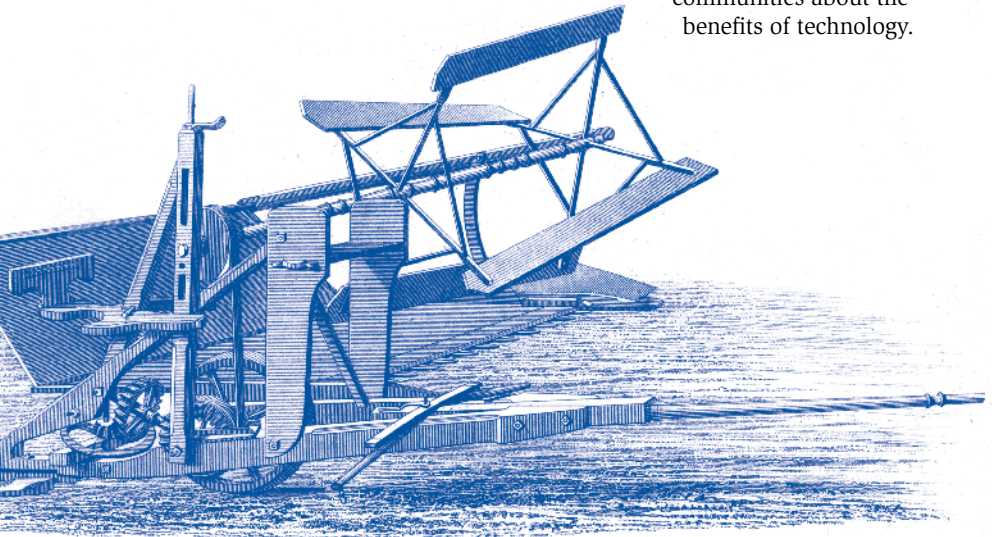



Henry Ford (1863–1947)

Most people credit Henry Ford with inventing the automobile. The fact is, he didn't. Such a complex machine was the result of a combination of technologies developed by many people over time. However, he did invent the moving assembly line, which revolutionized the way we make cars and affected the cost.

In 1908, Ford's company began selling his famous Model T for \$850. Though inexpensive for its day, it proved to be sturdy, reliable, and easy to operate. It quickly became popular, and Ford soon found he was unable to meet the enormous demand for his cars.

His solution was to invent a moving industrial production line. By installing a moving belt in his factory, employees could build cars one piece at a time, instead of one car at a time. This principle, called *division of labor*, allowed workers to focus on doing one thing very well, rather than being responsible for a number of tasks.

Ford found that his new system produced cars quickly and efficiently; so efficiently that the cost of assembling cars was lowered considerably. He passed this savings along to his customers, and in 1915, he dropped the price of the Model T to \$290. That year, he sold the millionth Model T.



Henry Ford's invention of the moving assembly line made the efficient economical manufacture of automobiles possible.

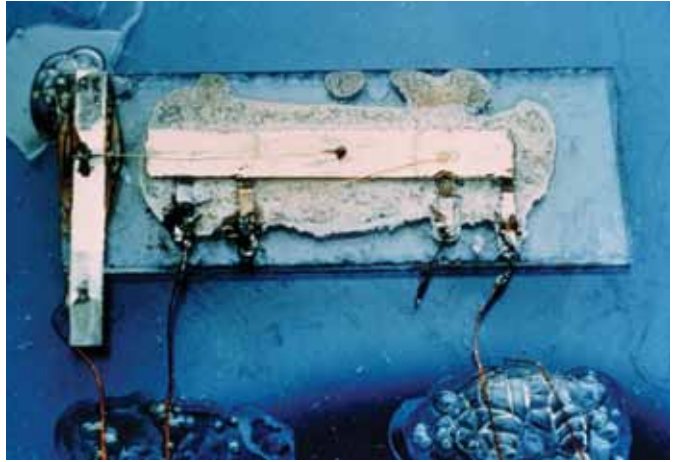

Jack Kilby invented the integrated circuit at Texas Instruments in 1958. Composed of only a transistor and other components on a slice of germanium, Kilby's invention, $\frac{7}{16}$ by $\frac{1}{16}$ inches in size, revolutionized the electronics industry and our lives.

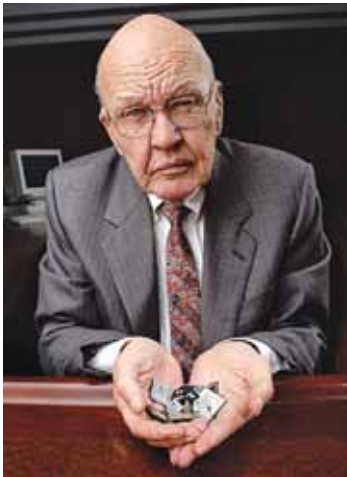

Jack Kilby (1923–2005)

For one invention alone, Jack Kilby can be justly considered one of the greatest electrical engineers of all time. He invented the *monolithic integrated circuit*, or *microchip*, which made *microprocessors* possible, thereby allowing high-speed computing and communications systems to become efficient, convenient, affordable, and used everywhere.

After earning a Bachelor of Science degree in electrical engineering at the University of Illinois in 1947 and a Master of Science degree in electrical engineering at the University of Wisconsin in 1950, Kilby took a research position with Texas Instruments Inc. in Dallas, Texas. Within one year, Kilby had conceived and created a small, self-contained, *monolithic integrated circuit* in a single piece of semiconductor material about the size of a fingernail. At the first professional presentation of his invention at the Institute of Radio Engineers Show of 1959, Kilby's colleagues were both astonished and overjoyed—and a new generation of computers and microelectronics was born.

Kilby went on to develop the first industrial, commercial, and military applications for his integrated circuits—including the first pocket calculator (the Pocketronic) and the first computer in which the integrated circuit was used. By the mid-1970s, the microchip formed the basis of modern microelectronics. Without it, no personal computer, fax machine, cell phone, satellite television, or any other computer or mass communication system would exist.



The breadboard (construction base) for the first electronic hand-held calculator fills a room.

For his invention of the integrated circuit, Kilby was awarded the Nobel Prize in Physics in 2000. Also credited with the invention of the thermal printer and the hand-held calculator, Kilby had patented more than 60 inventions.

Cyrus McCormick, Henry Ford, and Jack Kilby all solved important problems with technological solutions. Their solutions significantly impacted the quality of life, standard of living, and nature of modern society.



Inventors in the Community

Because of inventions, people can live longer, be more comfortable, and lead more productive lives. It is therefore easy to see that inventors are important members of the community. One

way to locate inventors living in your community is to research a *patent*. Inventors can legally protect their inventions, just as McCormick, Ford, and Kilby did, by patenting them with the U.S. Patent and Trademark Office (USPTO).

The U.S. Patent and Trademark Office is one of 12 bureaus under the U.S. Department of Commerce. The department's mandate is "to advance economic growth and jobs and opportunities for the American people. It has cross-cutting responsibilities in the areas of trade, technology, entrepreneurship, economic development, environmental stewardship, and statistical research and analysis."

Through the U.S. Patent and Trademark Office, inventors can obtain legal protection for a period of time in exchange for **sharing their ideas** with the public. In the United States, current patent laws generally grant protection for 20 years from the date the patent is filed with the U.S. Patent and Trademark Office. Patents give the inventor the "right to exclude others from making, selling or using" the invention. Anyone who tries to benefit financially from the patented invention, or uses it without licensing it from the patent owner, can be found guilty of *patent infringement*, and may be required by law to pay the inventor a royalty, lost profits, and maybe even punitive damages.



The 12th edition of the *Boy Scout Handbook* and the *Computers* merit badge pamphlet include tips on avoiding Internet dangers.



One important objective of the patent system is to help inventors justify the effort and expense of making something that is new and useful. For some inventions, like new pharmaceutical drugs, the expense can be millions of dollars and can take many years of work, so the prospect of getting a patent that excludes others from making and selling the drug offers an incentive for companies to invest in the research and development.

Can you locate an inventor in your community? Listed below are a few suggestions to help you.

- Ask the reference librarian at your local library.
- Talk to an engineer or entrepreneur.
- Call a local manufacturing business.
- Use the Internet (always with your parent’s permission first).

The Internet, designed in 1973, was fully operative within 10 years. It can “bring the world” to you. The Internet is a tool to be used appropriately to gain information while avoiding dangers. Web sites that will help you locate inventors in your local community are listed in the resources section at the back of this booklet. Remember, if you send an e-mail to an organization asking for information, be sure you have your parent’s permission before doing so.

FreePatentsOnline

This free search engine is fast and easy. (Check out some of the crazy patents.) To search for a patent that was granted to an inventor in your community, use the Quick Search tab and fill in the name of your city and state. Be sure you have your parent’s permission first.





Designing and building pinewood derby cars involves solving many problems, but pinewood derby cars are not inventions because they are not unique solutions.

From Problem Solving to Inventing

Boy Scouts solve problems all the time. If you sprain your ankle while hiking, your Scout patrol can make a crutch for you by using a tree branch. Three ropes, a few lashings, and wood supports become a bridge to cross over a bog. Remember the pinewood derby races from Cub Scouting? Building a pinewood derby car was all about solving problems in order to be the fastest 5-ounce car made from a block of pine with four nails for axles and plastic wheels. While pinewood derby cars are solutions, they are not inventions. Why? Because they are not *unique* solutions.

Invention is at one end of the problem-solving spectrum; **routine problem solving** is at the other end. As you move toward invention, you are moving away from predictable and specific solutions. By creatively thinking about a problem, you can find a unique solution. Sometimes, this creative thinking becomes breakthrough thinking (a *Eureka!* moment) when you connect the problem you are trying to solve with something from an unrelated area.



The spectrum of problem solving

From Bridges to Backpacks

John Fabel was an inventor whose creative thinking about a problem led to a breakthrough. John was trained as a geographer and designer. His work as an inventor involved environment, community, and design. As a child, he continually asked **What if** questions: **What if** I could make this work better? **What if** I built this?

By creatively thinking about a problem, you can find a unique solution. Sometimes, this creative thinking becomes breakthrough thinking when you connect the problem with something totally unrelated.

Because of the way he looked at problems, he was able to see a connection between the suspension bridges he saw in New York City and the problem he was trying to solve. This thought process led him to design a backpack that would distribute weight evenly so that after long hours of cross-country skiing, the straps of his backpack wouldn't bruise his shoulders. That is *breakthrough thinking*, sometimes referred to as a *Eureka!* moment.

The EcoTrek™ backpack that John Fabel invented does not rely on shoulder straps to carry the load. It transfers much of the weight to the hips. When wearing it, your hips act like a tower on a suspension bridge, and the backpack is similar to the roadway. Like cables on the bridge, the triangular flap between the backpack and the hip belt helps distribute the weight evenly. John filed for a patent on his backpack design in 1995. It was granted in 1997. Initially, he manufactured and sold his backpack directly to customers, but eventually he licensed the design to Marmot, a maker of backpacks, tents, sleeping bags, and outdoor clothing.

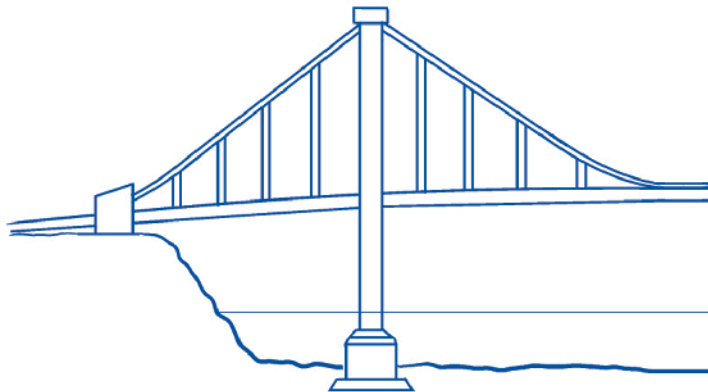



Inventor John Fabel was a Scout in western Massachusetts, as were his father and grandfather.

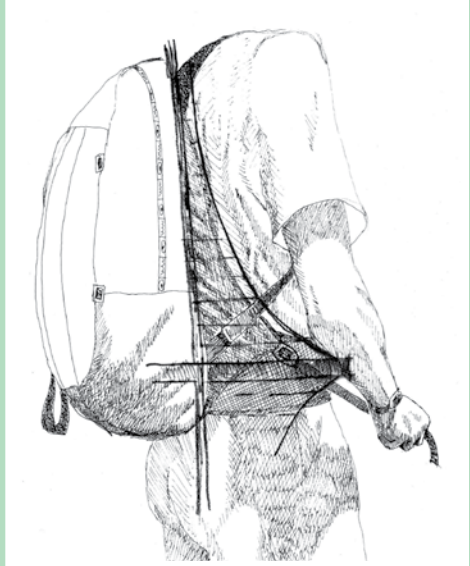

Fabel's EcoTrek™ backpack does not rely on shoulder straps to carry the load because it transfers much of the weight to the hips.

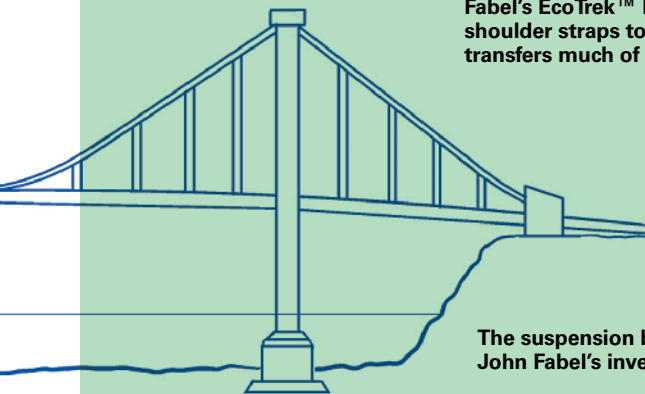

The suspension bridge helped inspire John Fabel's invention.

Who Says You Can't Rappel...in Reverse?

Nate Ball had a passion for inventing long before he could define the word. He recalls that at age 2, he dug up the family garden to build, wreck, and rebuild mud dams and underground forts. In the fourth grade, he created a bottle rocket launcher that shot two-liter bottles of water 100 feet into the sky. This creation was followed in sixth grade by a hovercraft powered by a vacuum cleaner motor.

By the eighth grade, he was attempting to build a Tesla coil in his parents' garage, making capacitors out of glass bottles and aluminum foil. "I saw Tesla coils on the Internet shooting lightning," said Ball. "It was the coolest thing I'd ever seen, and I knew I had to build one." Amazingly, Ball did not touch a machine tool until he was in college. He credits limited resources during his early years with forming his ability to think unconventionally about problems and to come up with efficient solutions.

In 2004, along with three other mechanical engineering students at the Massachusetts Institute of Technology, Ball founded Atlas Devices, LLC. The goal of the company was to develop and commercialize the ATLAS Powered Rope Ascender, which uses a rope-handling mechanism, conceived by Ball. This portable device can raise more than 250 pounds at 10 feet per second, giving rescuers, emergency personnel, and soldiers faster and more controllable climbing capabilities. The U.S. Army awarded funding for this invention.

Ball is a coapplicant of six patents, two of which have been granted. His awards and achievements include the SAIC Award in the 2005 Soldier Design Competition, sponsored by the Institute for Soldier Nanotechnologies at the Massachusetts Institute of Technology, for his team's ATLAS Powered Rope Ascender. He also won the Luis De Florez Design and Innovation Award in 2005 for outstanding ingenuity and creativity from MIT's Department of Mechanical Engineering for an electric scooter. Nate Ball received his undergraduate and graduate degrees in mechanical engineering from MIT.



Nate Ball using the ATLAS Powered Rope Ascender

Inspired by his mother, a music teacher, and his father, an engineer, Ball enjoys sharing his passion for science and invention with others. He has hosted the PBS series *Design Squad*, which aspires to excite middle-school students about science and engineering by combining elements of reality television with fun and educational engineering challenges.



Inventor Nate Ball demonstrates reverse rappelling over a pool using the patented ATLAS Powered Rope Ascender. Nate was awarded the \$30,000 Lemelson-MIT Student Prize in 2007 for his inventiveness.

A Street-Legal Airplane

Carl Dietrich traces his earliest design innovations to his childhood, building tree forts in his backyard and elaborate spaceships from Fisher-Price® Construx building sets. He credits his father's fascination with model planes as the inspiration that led to his passion for aeronautics and aerospace. By the time Dietrich entered high school, his inventive drive had produced remote-controlled airplanes and designs for a hydrogen-powered aircraft.

Dietrich earned his undergraduate and graduate degrees from MIT including a Ph.D. in 2006 in aeronautics and astronautics. His doctoral work led to an efficiency improvement design that he patented for a desktop-size Penning Fusion Reactor, following a research internship at Los Alamos National Laboratory in 2002. Carl Dietrich credits this internship with sparking his initial curiosity about a distributed network of reactors that could potentially replace the strained power grid of the United States.

In 1998, Dietrich cofounded the MIT Rocket Team. He holds a patent for his Centrifugal Direct Injection Engine—a low-cost, high-performance rocket propulsion engine. The CDIE operates without a conventional turbo pump pressurization system, which greatly reduces its complexity and cost.

He also invented the PickProd—a blast-safe demining pick for safer removal of antipersonnel landmines in environments with hard-packed earth, like Afghanistan. He made the decision **not to patent his invention, so it could be used by anyone in need.**



"The best way to think of an invention is to think of a need," says inventor Carl Dietrich.



The Transition's folding wings are the unique invention that make it different from a flying car.

In 2006, Carl Dietrich and four MIT colleagues (and fellow pilots) launched a start-up company called Terrafugia to create the **Transition**, a personal air vehicle (or PAV) concept. The Transition completed its flight test program in June 2009. First delivery of the Transition is expected in 2011. It will make use of the nation's thousands of underutilized public-access airports by providing a practical transportation alternative to travelers whose destinations are 100 to 500 miles away. The Transition vehicle can be driven on any type of surfaced road, requires only a sport pilot's license to fly, and operates on premium unleaded gasoline. According to Dietrich, it's not a flying car; it's a road-able aircraft.

Carl Dietrich has four patents pending for the Transition, including overall configuration, deformable aerodynamic bumpers, embedded lights, license plate holder, and an RFID (radio frequency ID) system for rapid access to local airports.

Inventors in Your Community

As previously described, the Internet can help you find inventors in your local community by researching their patents. Inventors may choose to patent their inventions in order to protect their ideas. They may find out how to apply for and receive a patent through the U.S. Patent and Trademark Office. When a patent is granted by the U.S. government, the invention receives a U.S. Patent number. While you can search for patents on the U.S. Patent and Trademark Office web site, there are other web sites that might be easier to use.

Remember to always have your parent's permission *before* you use the Internet.

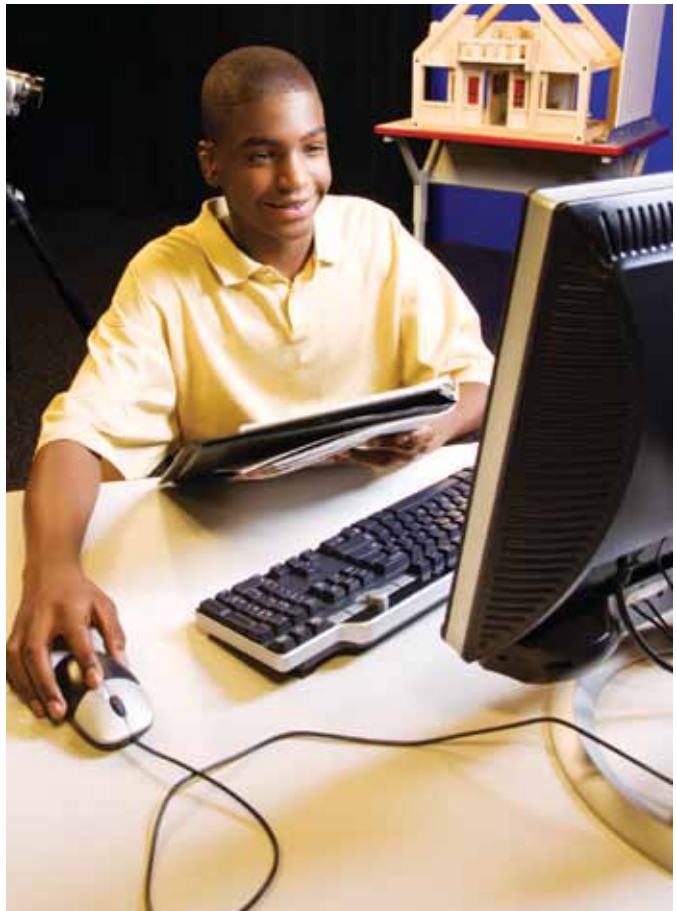

Google.com/patents

This site is easy to use, particularly if you already have the U.S. Patent number. This is a beta site, which means it is still being developed. Therefore, it may not list the latest patents granted by the U.S. Patent and Trademark Office.



FreePatentsOnline

The FreePatentsOnline Web site allows users to easily search by the inventor's geographical location. Searches also can be conducted chronologically beginning with the most recent dates. To search, use the "expert" or "quick" functions. You will not be required to create a free account.

U.S. Patent and Trademark Office

The U.S. Patent and Trademark Office is the definitive site for all official patent and *trademark* issues, two of the three types of intellectual property that can be protected. The site informs the public about patents, trademarks, and intellectual property law. Searching for patents on this powerful Web site is a more complicated process than searching on Google or FreePatentsOnline.

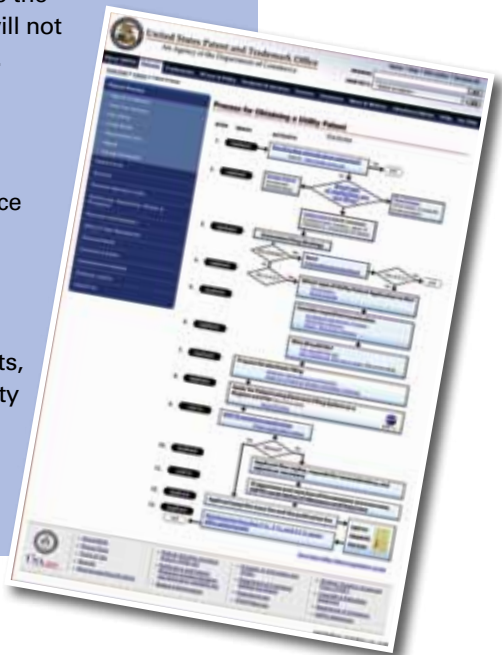

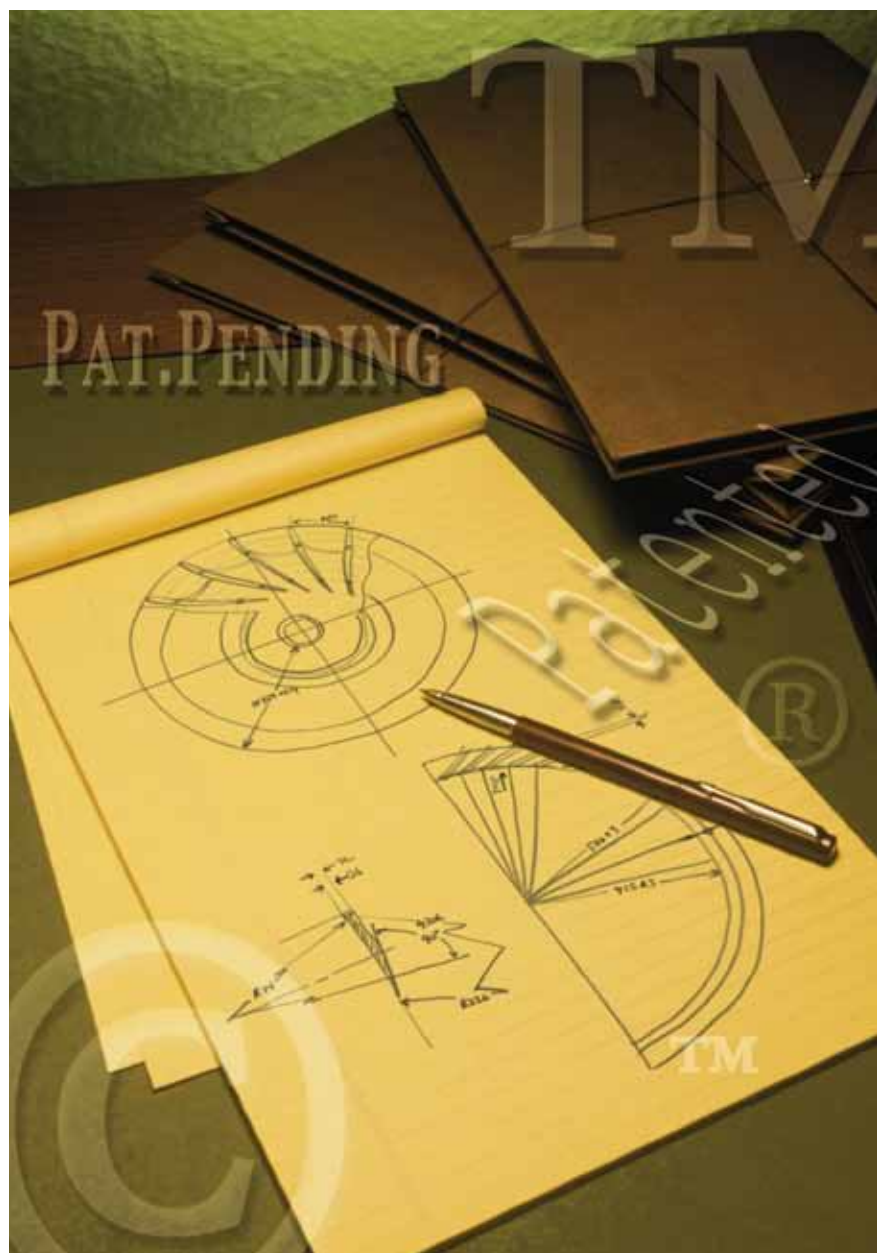

Intellectual Property, Patents, and Trademarks

It is important to be familiar with the laws of the United States that protect the property of inventors. The contributions of inventors result in a better quality of life for others in our society, and those inventors have the right to enjoy the financial benefits derived from their hard work and persistence in solving problems that lead to invention and innovation.

What Is Intellectual Property?

Thinking creatively to solve problems often leads to interesting and unusual solutions that have not been obvious to others. These solutions can become inventions and may be patentable. A *patent* is one type of *intellectual property* that can be legally protected through the U.S. Patent and Trademark Office.

Two other types of intellectual property that can be legally protected are *trademarks* and *copyrights*. Trademarks are legally protected through their registration with the U.S. Patent and Trademark Office. Copyrights are for authored works, like books and music, and are legally protected through their registration with the Copyright Office in the Library of Congress.

Intellectual property represents ideas and work of the intellect. It has value in the same way that physical property like land, houses, and cars have value. Because it is more difficult to protect and keep track of intellectual property and its value than physical property, intellectual property owners have special protections enacted by the government through patents, trademarks, and copyrights.

What Is a Patent?

Patents legally protect the intellectual property of the inventor by limiting the use of the unique and useful idea for up to 20 years. According to the U.S. Patent and Trademark Office, a patent gives the inventor “the right to exclude others from making, using, offering for sale, or selling the invention” in the United States. A U.S. patent protects the inventor only in the United States or in U.S. territories and possessions that are under the jurisdiction of the U.S. federal government.

There is no international patent system. Foreign countries have their own patent systems. Therefore, if a U.S. citizen wants patent protection in another country, he or she must file there separately, following the rules of that country or union of countries.

Since the U.S. Patent and Trademark Office is the authority on patent protection in the United States, it is best to refer to that office for official definitions and information. The office indicates that there are three types of patents that inventors may be granted.

1. A *utility patent* may be granted to someone who invents or discovers any new and useful process, machine, article of manufacture, or composition of matter, or any new and useful improvement thereof. This is the most common type of patent. For example:

US 7,581,715 B2 for Powered Rope Ascender and Portable Rope Pulling Device invented by Nathan Ball, Timothy Fofonoff, Bryan Schmid, and Daniel Walker, and assigned to Atlas Devices, LLC, in Cambridge, MA.

This patent is shown later in this chapter.

2. A *design patent* may be granted to one who invents a new, original, and ornamental design for an article of manufacture. For example:

US D437,673 S for a jacket with a waterproof pocket invented by Karen Lugossy DesJardins and Aubrey B. Vaughn, and assigned to Marmot Mountain Ltd., Santa Rosa, CA.

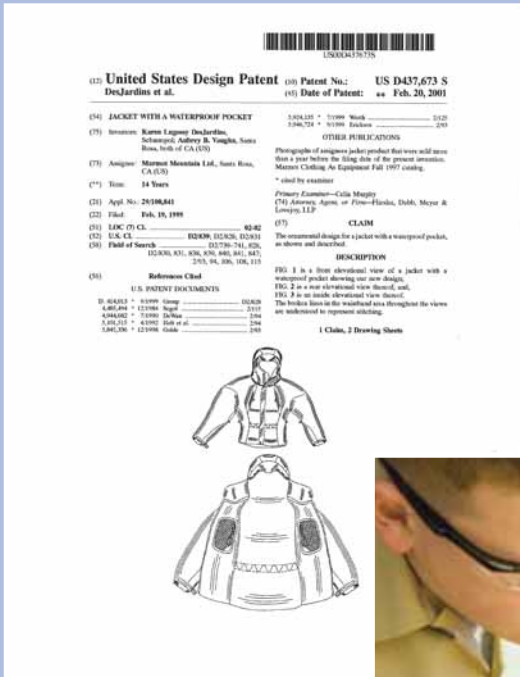

A design patent for Marmot Mountain's jacket with waterproof pocket.

3. A *plant patent* may be granted to one who invents or discovers and asexually reproduces any distinct and new variety of plant. For example:

US 7,256,335 B1 for PLANTS AND SEEDS OF HYBRID CORN VARIETY CH403115 invented by Nathaniel J. Page, Madison, WI, and assigned to Monsanto Technology, LLC, St. Louis, MO.



President George Washington established the U.S. Patent Office in 1790. Even at the very beginning of our country's history, the value of protecting intellectual property was recognized. While there have been many changes to patent laws and the governing of intellectual property, the focus on protecting it remains important to our country. From three patents in 1790 to approximately 8 million patents today, unique and useful solutions to real-world problems are protected through the U.S. Patent and Trademark Office.

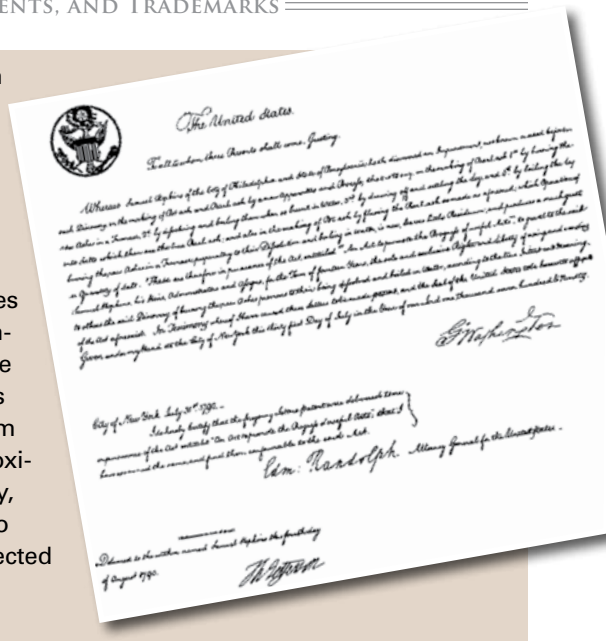

Components of a Patent

Patents reveal treasure troves of information. Because one of the requirements for a patent is **full disclosure of the invention**, you can read detailed information as to how a particular technology works. Most technical information found in patents does not exist anywhere else, so the USPTO is an excellent place to learn about how things work.

Though the Patent Office was established in 1790, the current numbering system for patents was not established until 1836, with the first utility patent. The first design patent was granted in 1842, and the first plant patent was granted in 1931.

This patent, granted to inventor Nathan Ball on Sept. 1, 2009, is U.S. Patent 7,581,715 B2 for the Powered Rope Ascender and Portable Rope Pulling Device.

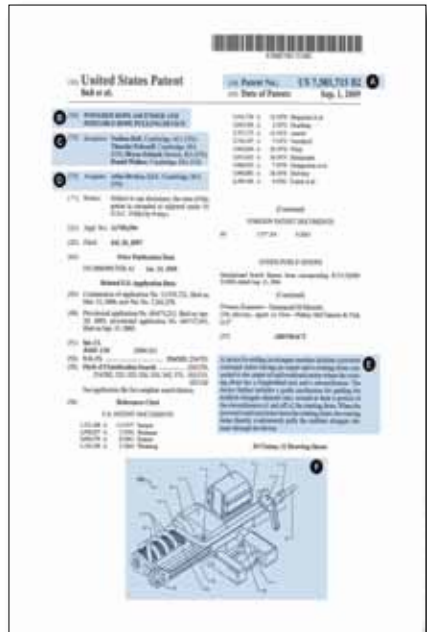

The basic parts of U.S. patent 7,581,715 B2 are:

A	Patent Number	US 7,581,715 B2	Unique number issued by USPTO within each class of patents (utility, design, plant)
B	Title	POWERED ROPE ASCENDER AND PORTABLE ROPE PULLING DEVICE	Technical title of the invention
C	Inventors	Nathan Ball Timothy Fofonoff Bryan Schmid Daniel Walker	Four inventors are listed for this invention.
D	Assignee	Atlas Devices, LLC	Intellectual property can be assigned to a company or another individual. Here, the inventors assigned (transferred) the patent to Atlas Devices, LLC, the company they started to manufacture and sell the invention.
E	Abstract		Short, one-paragraph overview of the invention
F	Drawings	11 drawing sheets or figures	
	Description	A detailed description of the invention begins in column 3, line 47, and ends in column 9, line 51.	The description should fully disclose the technical details of the invention so that someone skilled and knowledgeable could build or make it. Patents do not have page numbers but rather column and line numbers.
	Claims	The 20 claims begin in column 9, line 52, and end in column 12, line 10.	Claims, found at the end of a patent document, determine the legal boundary of the patented invention. The description and drawings support the claims.

Trademarks

Trademarks represent the other type of intellectual property protected by law and registered through the U.S. Patent and Trademark Office. As defined by the USPTO:

“[A] trademark includes any word, name, symbol, or device, or any combination, used, or intended to be used, in commerce to identify and distinguish the goods of one manufacturer or seller from goods manufactured or sold by others, and to indicate the source of the goods. In short, a trademark is a brand name.”

Once a trademark is registered with the U.S. Patent and Trademark Office, the company may add the symbol “®” to the trademark. **A registered trademark may be protected indefinitely as long as it is continuously in use.**



The trademark is visible on this lantern sold by the Coleman Company.



You may be familiar with trademarks from your camping gear. For instance, the Coleman Company Inc. of Wichita, Kansas, owns this image for recreational sports equipment.



Patented Inventions Are Unique and Novel

In order for a patent to be granted, four criteria must be met.

1. An invention must be unique and novel. Simply changing the color or size of something that already exists does not qualify as unique and novel.
2. To a person who is familiar with the problem, it must not be an obvious solution. For instance, if you have invented a new technology for treating water for backpackers, the new technology must not be obvious to someone who works in water treatment.
3. Full disclosure of the technical details of the invention must be given in the patent application. An idea cannot be patented.
4. An invention must work and be useful. The U.S. Patent and Trademark Office specifically says: "The term 'useful' in this connection refers to the condition that the subject matter has a useful purpose and also includes operativeness, that is, a machine which will not operate to perform the intended purpose would not be called useful, and therefore would not be granted a patent."

To find out more about patents, you might contact a patent attorney (with your parent's approval and permission first) in your community after studying the U.S. Patent and Trademark Office Web site.

The technical information contained in a patent often cannot be found anywhere else.

Nonpatented Inventions

Not all inventions are patented. Some inventions can do so much good that their inventors decide to make them immediately and widely available, like Carl Dietrich's PickProd, the blast-safe demining pick for safer removal of antipersonnel landmines in environments with hard-packed earth. Inventors may decide that their inventions can be of such great help to people in poor or technologically disadvantaged areas of the world that they choose not to pursue a patent, thus allowing the invention to be used by anyone in need.

One example of a nonpatented invention is computer software that is considered *open source*. This means that anyone can use the software without paying a fee to the inventor. The Linux operating system is a good example of open source software. Linus Torvalds is the "father" of Linux, which he began developing when he was a college student in Finland during the early 1990s. Because it is open, many people have contributed—and may contribute—to its development over time.

In 1991, Linus Torvalds decided that his new MS-DOS-driven PC needed an alternative operating system. He had enough programming expertise to assume that he could achieve this himself. His goal was to create a UNIX-like operating system for home use. Guided by *Design of the UNIX Operating System*, written by Maurice J. Bach, he began creating the system, working long, hard hours until, at age 22, he completed a rough version. He called his system Linux, a combination of UNIX and his name, and posted the source code on the Internet, free of charge.

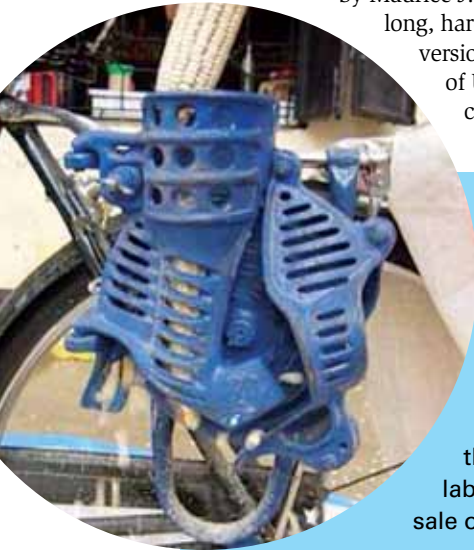

Inventors Are Humanitarians

Inventors may choose not to patent devices that can be of great help to people in need. This bicycle-powered device, which was field tested in Tanzania, shells corn 40 times faster than by hand. This frees people of manual labor and generates an income from the sale of excess corn kernels.

Linus Torvalds' philosophy was that if he made the software available for free downloading, including the source code, anyone with knowledge of and interest in computer programming could modify the system and ultimately make it better, even modify it for specific purposes. Linux quickly gained popularity among savvy computer users. Licensed under what is called a GNU General Public License, the system remains free to anyone who can get, use, modify, distribute, and copy it.

Open source is important to people who are working with computer technologies to help improve the lives and economic conditions of people living on less than \$2 a day in developing countries. When John Hilliard, Eagle Scout from Troop 42, Baden-Powell Council, in upstate New York, went to Uganda, East Africa, for a service project, he downloaded as much open source and free software as possible. His notable downloads are listed below.

- **Wikipedia**, freely available online
- **Ubuntu**, freely available Linux-based operating system
- **Project Gutenberg**, a collection of noncopyrighted books
- **Open Office**, free productivity software

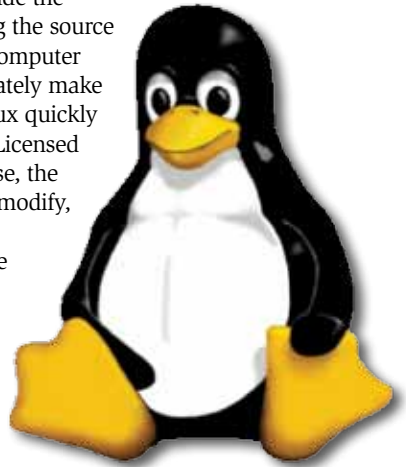

This is the official Linux Penguin, which was selected by Linus Torvalds and designed by Larry Ewing. The penguin is not a registered trademark, and anyone can freely use it.



**John Hilliard,
Eagle Scout**

John Hilliard joined a friend who was volunteering with the Peace Corps as a science teacher at a teachers' college in Kabulasoke, a small village in Uganda. The school had a computer lab, but no one except Hilliard's friend knew how to use or maintain it. Nor was there a curriculum in place for teaching students computer equipment maintenance. The students did not even know how to use a mouse. In terms of software, the computers had only basic software, so students were not motivated to learn how to use the computers. Free and open source software made the computers more interesting and useful for the students.

John Hilliard used skills he had learned from his Eagle Scout leadership service project, which involved setting up a computer network in a local community center. As you know, an important part of the Eagle Scout project is getting approval.

Though the process can be time-consuming, it prepares young men for grant writing and obtaining funding for future projects. Hilliard's Eagle Scout experience proved useful when he sought funding for the Uganda project.

Hilliard said: "The experience of the Eagle Scout project also gave me confidence that I could actually help. Going to Uganda to help in a computer lab isn't a small task, so it helped that I already had community service experience under my belt. I think also being an Eagle Scout is partly what motivated me to help in the first place. Being a Scout teaches you that you should help other people at all times. It's also in the Scout law that a 'Scout is helpful.' So after probably about 13 years of Scouting, it was just instinct to help my friend and his school after realizing that I could offer a lot of help."

Inventors are curious and empathetic leaders. They creatively think of ways to improve the lives of others.

Computer skills in developing countries are growing in importance. One inventor, Joel Selanikio, has established a program in Kenya, Africa, to create computer science technology centers for young men and women to further their careers. Developing countries have mobile technology. Joel Selanikio's company DataDyne, which he cofounded with technologist Rose Donna, developed EpiSurveyor in collaboration with the Kenyan Ministry of Health. This was in response to Selanikio's realization that the low utilization of mobile computers, including personal digital assistants (PDAs) and mobile phones, for data collection and analysis stemmed from the complexity and cost of available software, rather than the hardware itself.

EpiSurveyor utilizes a free, open-source mobile software program that makes data collection a more manageable and eco-friendly task for public health workers. EpiSurveyor is now being used as a World Health Organization standard method of data collection. One of the Kenyan students involved with the technology center established by Dr. Selanikio has contributed to the EpiSurveyor project, and young students are helping sustain the data collection of important health-care statistics.



In Africa, cell phones are used to gather health information.



Inventing Closer to Home

Each time you go camping, you take camping gear to keep you dry, help you prepare food, and find your way on hikes and watercraft trips. The products you rely on represent years of research, development, refinement, and input from numerous inventors. Many of these items are either patented or patent pending—meaning a patent application has been filed with the U.S. Patent and Trademark Office and is being processed. Below are examples of a few common camping items and their U.S. patent numbers.

Camping stove	U.S. Patent No. 5423308; patented in 1995
Tent with screen porch	U.S. Patent No. D418572; patented in 2000
Disposable rain poncho	U.S. Patent No. 3665518; patented in 1972
Coleman Evanston™ 8Tent (w/ Hinged Door)	The hinged door component of the Evanston™ 8Tent is patent pending

When you prepare for a camping trip, do you consider the environmental conditions where you will be spending the night? What is the weather forecast? What do Scouts who have previously camped there recommend? Can you use gear made of particular material without harming the plants and animals that live nearby? Can you purchase environmentally friendly equipment to protect our planet?

The Leave No Trace principle of Scouting is held in the highest regard. This means that, whenever possible, you and other Scouts should make every effort to minimize the environmental impact of your actions and the gear you use. As you make these considerations, you can think inventively to devise solutions to your problems—not least of which are issues concerning outdoor gear.

Think inventively about how to make your camping equipment more useful. What problems do you have with your equipment? Can you think of any solutions? While this might be routine problem solving, it is an excellent way to start inventing.



How would you improve a mess kit?

How Would You Improve on These Items?

Coleman Mess Kit. As commonly used camping products, mess kits are subjected to heavy use and a variety of environmental conditions. If your mess kit shows signs of rust or bends easily, you might suggest that the manufacturer consider using different materials in its construction. When buying a mess kit, it is important to consider the material from which it is made. For example, if you

camp in areas prone to extreme temperatures or heavy precipitation, you need gear that can withstand the conditions. Do you have suggestions for improving the durability of your mess kit? Do you have other suggestions for its improvement?

Coleman Camping Coffeemaker. You might suggest making improvements to its safety or structural stability. An outdoor environment poses unique challenges. Where will you find a stable surface to place your food prep equipment? Might the coffeemaker base need to be shaped differently? Might a different material be more durable?



How would you improve this outdoor coffeemaker?

Coleman Sundome® 5' x 7' Backpacking Tent. As you know, a tent is the quintessential piece of gear for overnight outings. However, you have probably had your share of tent troubles. You know how it feels to discover that a part is missing, there is a hole in the material, or the zipper is stuck, especially when you are setting up camp as it is getting dark or raining!

Depending on where you camp, your tent may perform better than other tents under certain environmental conditions than others. For example, some tent materials are sensitive to intense, direct sunlight. Others are made with material that deflects sunlight and maintains structural integrity. Based on your camping experiences, how would you improve your tent? Can you think of problems you have encountered and offer ideas as to how they might be fixed?



How would you improve your tent?

For more inventive solutions that are creative and unique (and less routine), consider unrelated things and how they could help you solve a problem with your camping equipment. Can you relate an umbrella or a bicycle pump to putting up a tent? What inspiration is there in nature for putting up a tent? Generate solutions by combining unrelated factors. Remember John Fabel's suspension backpack. What is your "bridge?"

Think inventively about improvements to your own gear. The following matrix might help spark ideas for making improvements to your camping gear.

	Current Usefulness	Improving Marketability and Appearance	Improving Function
Propane Lantern	Used for lighting entire camp area.	Different sizes needed; could use a transport case.	Needs a switch to turn on light. Needs to be adjustable for different light intensity. Needs to hang more easily.
Flashlight	Used when camping at night for making trips to tents, cabins, or bathrooms.	Choice of colors and sizes would be welcome.	Needs to be waterproof. Could be brighter with LEDs. Provide extra battery pack and bulbs with purchase.
Leatherman® Multi-Tool	Used as a screwdriver, can opener, and saw.	A selection of colors for easy identification would be beneficial. Add graphics; customize with name.	Additional features would be fire starter (lighter or magnesium stick). Pen/pencil would be useful. Flashlight with tools would be useful. Hot pot lifter. Wire strippers.
Hiking Shoes	Used for walking and hiking on varying types of terrain.	Different graphics on shoes, maybe camouflage.	Make boots fireproof. Cover with material that does not attract burrs.

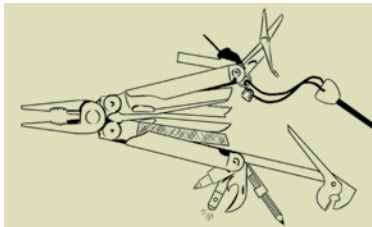

Boy Scouts from Troop 4 in Brillion, Wisconsin, thought the functionality of a Leatherman multi-tool could be improved by adding a hot pot lifter and fire starter.

The Leatherman Multi-Tool Story

A scout knife was not the right tool to fix an old Fiat. The multi-tool was dreamed up in 1975 by Tim Leatherman when he needed pliers but had only a pocketknife. Five years later, he was granted U.S. Patent 4,238,862 for a pocket multiple tool. His idea became reality in 1983, when two mail-order companies offered his multi-tool in their holiday catalogs.

Tim is an inventor, engineer, and entrepreneur. After earning his degree in mechanical engineering, he found work as an English teacher, a helicopter mechanic, and in other fields. After he dreamed up the multi-tool, he made models out of cardboard. Then his brother-in-law taught him how to work metal. Tim eventually built a steel prototype of the multi-tool in his garage.

Tim's road to success was neither quick nor easy, but he didn't give up. Today, the Leatherman Tool Group employs almost 400 people and makes more than a million tools a year. Leatherman tools are sold in more than 80 countries. There are 46 Leatherman tools for activities ranging from bicycling to camping, fishing to gardening, and even Scouting.

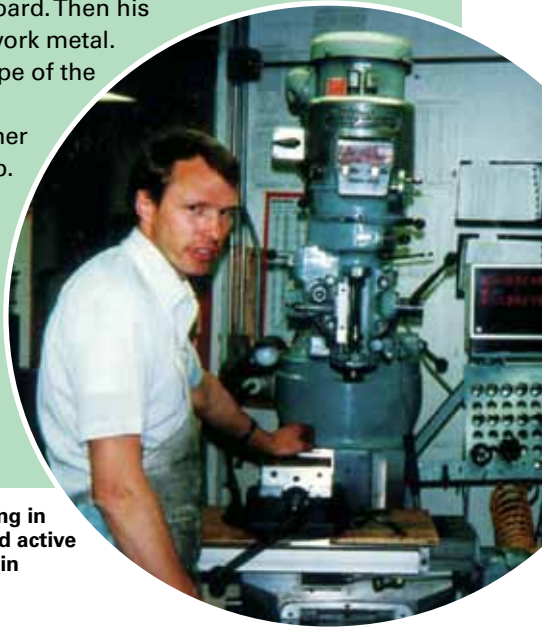

An early photo of Tim Leatherman working in his garage shop. Tim was a Life Scout and active in the Order of the Arrow from Troop 811 in Portland, Oregon.



A laboratory or engineering notebook is as important today as it was when Jack Kilby was recording his ideas for the microchip.

Record Your Ideas

It is important to keep a notebook of your ideas. When you see a problem that needs to be solved, write it down. What are you curious about? What bugs you? When you come across something that doesn't work the way it should, write down ways to make it better. Keep an Idea Matrix, like the one the Boy Scouts from Brillion, Wisconsin, used for the improved Leatherman Multi-Tool. If you develop the habit of recording your ideas, you will never be at a loss for a good problem to work on solving.

As you record how you would solve a problem, your idea will move forward from an idea to something real. Be aware that notebooks become permanent records and can be used to establish who was "first to invent" an item. The U.S. Patent law states that inventorship is based on "first to invent," not "first to file" a patent application.

Since a notebook is a permanent record of your ideas, some thought should go into the form of your entries. Your notebook binding ideally should be sewn and not spiral bound, preventing pages from being easily torn out. Inexpensive composition books have sewn bindings, as do more expensive laboratory or engineering notebooks, available at office supply stores. Since drawings will be part of your record, grid paper is preferable to lined paper.

You often learn from your mistakes, so don't try to hide them. Mistakes may be valuable when you look back at your work.

Number and date each page of your notebook. Be sure to list dates chronologically and do not skip pages. After you have recorded your ideas and findings, add a suitable title to each page. Supplement your entries with hand sketches. If you add something printed to your notebook, tape it in securely. Handwriting should be neat and legible. All entries should be written with a pen, not a pencil. If you make a mistake, cross it out with a single line and add a note about what the error was. You cannot erase because you are using a pen. Don't use correction fluid.

It is important to have the bottom of each page in your notebook witnessed, signed, and dated by someone who understands what you are describing. Your Inventing Merit Badge counselor, science teacher, or perhaps an engineer are appropriate witnesses of your work. There are rules concerning the notebook as a permanent record for obtaining future intellectual property rights. So, early in your inventing career, get into the habit of keeping a notebook.

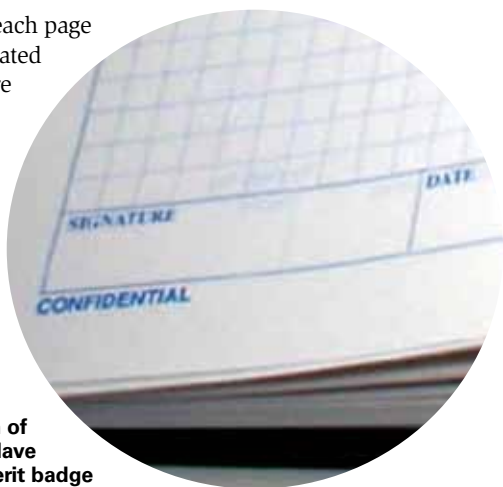

It is important to sign and date the bottom of each page in your engineering notebook. Have your ideas witnessed by your Inventing merit badge counselor or someone who understands your work.



The Inventing Process

There are so many possibilities for inventions that will solve problems and improve human existence. But if someone asks you to invent “right now,” your mind might very well draw a blank. In the inventing process, gather information, think about how to solve a problem, and narrow your focus. Here are a few tips to help you get started.

What to Invent

Inventing is probably easier when it involves items you use frequently, or activities you like to do or in which you have gained expertise. For example, you might like to ride horses. Have you noticed a problem in connection with your horseback riding experience? What about playing video games? Brushing your teeth? Would you like a better fire starter on campouts? Have you ever talked to your grandfather about his pocketknife options when he was a kid? Remember, Tim Leatherman’s idea for the multi-tool occurred when his scout knife would not do the trick to keep his old Fiat running.



How much more useful is the Leatherman SuperTool compared to a knife that was available to Scouts in 1911?



This is the scout knife that the New York Knife Company made in 1911.



As you ponder possible inventions, use the activities you enjoy to think of “spin-off” ideas. For example, if you are a horseback rider, imagine how the experience of riding a horse could be improved. What about the care of horses when they are not being ridden? What about feeding, grooming, or training horses? What could you invent that might be useful in these spin-off areas? Perhaps your horse-care ideas might spin off into pet care of other types of animals. If you have a pet, wouldn’t it be helpful if you didn’t have to feed and water your pet every day? You could invent new ways of caring for your pet while you are away for the weekend.

Merit Badge Design

Who invented the wheel, and why was it invented? Much of the early history of the wheel is not known because it was invented such a long time ago, in 5000 B.C. by ancient Mesopotamians. The wheel may be the very first technological invention. The earliest wheel was most likely for a potter’s wheel. The technology of wheeled travel was invented around 3500 B.C., about the same time as the domestication of the horse.

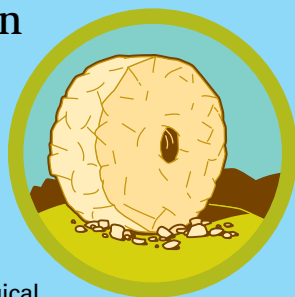

The wheel represents how something so basic and intuitively simple can have a profound effect on the history of humankind. What will Boy Scouts invent, and what impact will their inventions have on the history of humankind?

List Your Ideas

As you think about possible inventions, list ideas in your invention notebook. Your list might begin like this:

1. Toothbrush that does not need toothpaste squeezed onto it
2. Portable toolbox/stool with handle and storage space for brushes and equipment used to groom my horse
3. A water bottle that doesn't need to be held when filtering water into it
4. Bicycle tires that never go flat
5. Self-cleaning fish tank

Once you have listed your ideas, discuss them with your parent, merit badge counselor, Scout patrol, and friends, and select your three favorite ideas. Think about how you would turn these ideas into inventions. Identify the ONE idea that would be fun and feasible to work on, keeping in mind that an invention is useful, unique, and can be made to work.

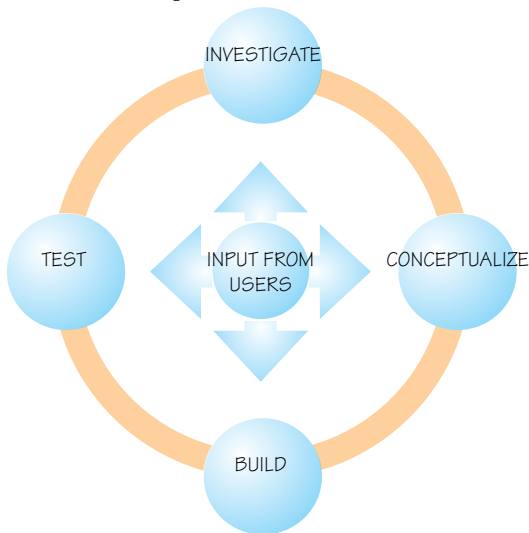

Inventing is a cycle; it is not a step-by-step process. Throughout the cycle, inventors get input from users or potential customers of the product they are inventing. Remember, an invention has to be unique and useful, so input is critical.



Boy Scouts discussing ideas for water bottles and attachment devices at San Juan High School in Blanding, Utah.

Investigate

Remember that you will not be the only user of your invention. The most successful inventions affect tens, hundreds, or thousands of people. Think about how many people use water bottles: school children, athletes, campers, and hikers. Some water bottles are disposable. Some are easy to hold. Still others may be insulated.

What if the water bottle had been designed to be useful only to the person who invented it? Its usefulness would be severely limited. Your invention should be appealing and desired by a broad range of people. Ask potential users of your idea what they think would be important in your invention, and include more ideas than just your own. The people you interview should know something about the idea, be interested in it, and currently use something similar. If you want to design a new water bottle for hiking, talk to Scouts, hikers, backpackers, park service workers, sporting goods store employees, and professionals who use water bottles in their work. Ask questions like:

- When do you use a water bottle?
- How often do you use a water bottle?
- What kind of water bottle do you use? Why?
- If you could change something about your water bottle, what would it be?
- What kinds of negative experiences have you had when using a water bottle?

Record the answers in your invention notebook.

Conceptualize

After you gather information from users, conceptualize your ideas on paper, both in words and with sketches. Describe your idea so that those assisting you could build a model from your notes. Do not worry if you cannot draw as well as you would like. You will improve with practice.

Continuing with the example of the water bottle idea, one of the challenges backpackers face is trying to hold a water bottle while pumping fresh water, standing in a running river. Come up with performance criteria about what you want your invention to do. This is the beginning of your invention statement. An example of an early invention statement might read like this:

I am inventing a clip that will slip around the neck just under the lid of a water bottle and attach to a belt, waistband, or backpack. It will attach easily and firmly but can be removed with minimal effort. The clip will never fall off the bottle, making it possible for one person to easily refill a water bottle through a filter device in a stream or river.

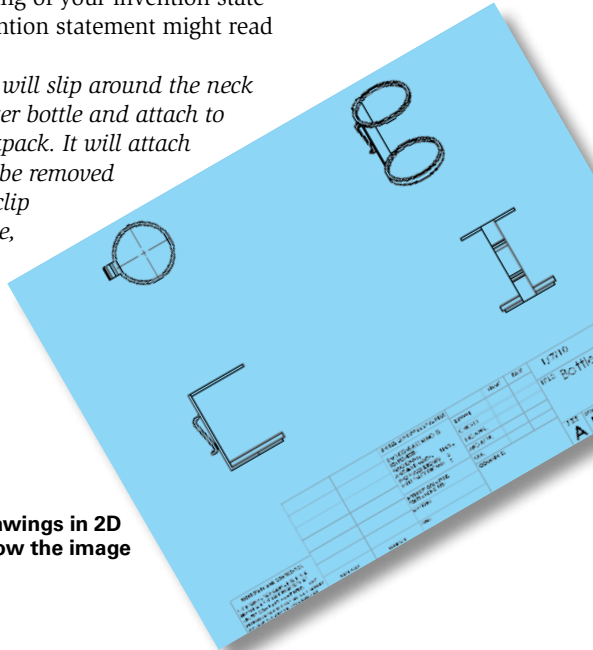

Water bottle clip in 2D CAD. Drawings in 2D CAD are usually printed and show the image as a 3-view drawing.

Water bottle clip in 3D CAD. Today, almost all drawings are done in 3D as models.



As you begin work on your invention, you will develop specifications based on what you and other users want. Record the specifications in your notebook. Add quantifiable terms to define your specifications. Use the invention statement to guide your development work. Modify the statement as you move through the invention process, as needed.

Although you don't have to be an artist, the drawing for an invention represents a critical piece of its description. Once you do your best sketch, have someone review it to determine whether you have visually and clearly communicated your invention.

Professional inventors use specific drawing techniques to communicate exactly what they want to build. These techniques follow critical guidelines regarding where things are and how to build them. This work, previously done by hand with pencil and drawing tools on drafting tables, has been done since the early 1980s in 2D (two dimensions) on the computer or through powerful *computer-aided design (CAD)* software.

The old way to create a drawing was to simply draw each view separately on a single page in *Front*, *Top*, and *Side* views. If a change was needed, it was time-consuming to redraw each view.

Today, when a 3D model is created, it can be changed in one drawing, the model, and printed out in three views. The new process is called *parametric modeling*.

There is software available to help you learn more about parametric modeling and how to use it. However, for this merit badge,

all you need is your notebook and a pencil. If you have never been exposed to technical drawing, you may want to earn the Drafting merit badge along with the Inventing merit badge.

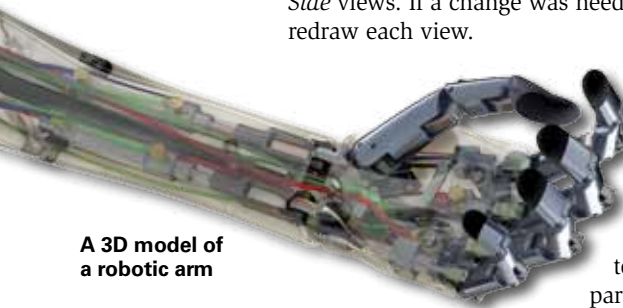

A 3D model of a robotic arm

Information on obtaining free access to SolidWorks® 3D CAD software is available in the resources section of this booklet. Enjoy experimenting with it. Have fun. Use the tutorials. However, be prepared to spend some time learning it well enough to build an invention from your 3D model.

Build a Model

For many, the model is one of most enjoyable parts of the inventing process. It is a critical step. Building a model gives you the chance to experiment inexpensively with many issues so you can fine-tune your concept.

Professionals usually begin by building scale models of new things like boats, vehicles, or airplanes that are expensive to create. Inventor Carl Dietrich did not begin by building his “road-able aircraft” at full scale.

Since a new airplane takes years to make and costs millions of dollars, a lot of time is spent making models of everything from the body and instrument panel to the ailerons and landing gear. By making models, inventors can refine design and mechanical issues and correct mistakes and make improvements before building the final product.

Models can be made from of a variety of materials: Clay, cardboard, wood, fabric, LEGO® blocks, metal conduit, and PVC pipe all are useful materials. Check out the trash. You will be amazed at what useful things you can find there.



One of Tim Leatherman's first models of a multi-tool was made of cardboard.



SR-71 Blackbird model

A model that accurately reflects the dimensions of a project at a reduced or enlarged size is called a scale model. For more information about scale, see the *Drafting* merit badge pamphlet.

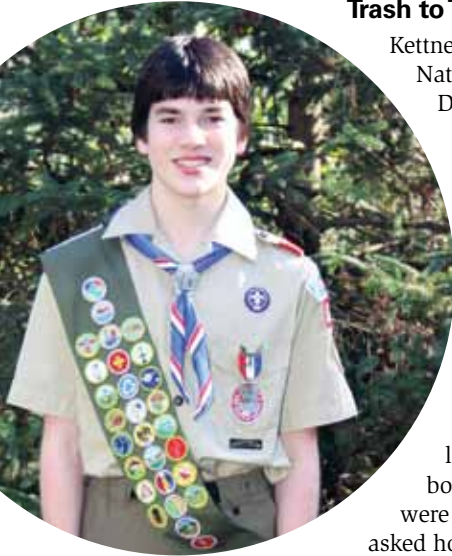

Inventor Kettner Griswold, Eagle Scout

Trash to Treasure

Kettner Griswold, an Eagle Scout from Troop 1427, National Capital Area Council near Washington, D.C., was one of the finalists in the 2008 Trash to Treasure design competition cosponsored by BKFK and “Design Squad,” the PBS reality television show about engineering and invention for teens. Kettner designed and built a water wheel from which energy could be harnessed—exclusively from trash.

Kettner used plastic bottles, a gutter nail for the axle, two sprockets recycled from a scooter (along with its motor, battery, and accompanying circuit board, from which he took a diode), a kitty litter bucket, and a circular bucket top, to which he attached the plastic bottles and coat hangers. The only tools he used were pliers, a hacksaw, and hot glue gun. When asked how he came up with his invention, Kettner says, “It was a pretty simple concept. **The hardest thing was finding a real problem to solve.**”

“To invent, you need a good imagination and a pile of junk.”
 —Thomas A. Edison, inventor



Building materials need not be new or expensive. Kettner used trash, recycled materials, and a few simple tools for his invention.

List Parts and Materials

When a model is complete and you are satisfied with the design, generate a list of the parts and types of materials for the actual invention. These lists will help you get an idea of how much it might cost to build the invention.

Parts List for Water Bottle Clip

Top ring	Ultrahigh Molecular Weight Polyethylene (UHMW PE)
Dimensions	Outside diameter, 2.4"; inside diameter, 2.2"; thickness, 0.125"
Base	UHMW PE Outside diameter, 2.4"; thickness, 0.125"
Back	Type 2024-T52 aluminum alloy Thickness, 0.10"; width, 0.75"; height, 5.0" To be stamped in shape shown on drawing
Clip	Type 2024-T52 aluminum alloy Thickness, 0.10"; width, 0.50"; length, 2.0" To be stamped in shape shown on drawing
Netting	5/16" plastic mesh; 1000/250 denier polyester Weight, 5.50 ounces per square yard Width, 5.0"; length, 6.5" To be thermally fused to top ring and base
Rivets	7 aluminum Diameter, 0.125"; length, 0.25" 3 rivets at top ring; 4 rivets at base

Getting input from users is important. However, if you do not have access to users of your invention, share your model and invention statement with your Inventing merit badge counselor, and ask for feedback.

Test in the Field

The final step of the invention is getting the best working model of your idea into the hands of potential users. Share your invention statement and model with users. This is called field-testing. Ask users for likes and dislikes about your model. Write those comments in your notebook and analyze them to see if you agree. Make a list of the things you would like to change when you build your next model.

Meeting Personal Needs

Gihan Amarasiriwardena, an Eagle Scout from Troop 504, Great Trails Council (now the Western Massachusetts Council), was inspired to invent a piece of lawn care equipment that didn't exist. From fifth grade through high school, Gihan had a small business taking care of lawns in his neighborhood. He saw that he could save time and earn more money by doing two lawn maintenance chores simultaneously—mowing and trimming. With parts given to him by a local lawn mower repair shop, Gihan added a trimmer assembly to a push mower.

Always interested in building tree forts or simply creating things with Erector[®] construction sets, Gihan learned to work with his hands so he could turn his ideas into reality. After Boy Scout campouts, Gihan began to see the need for low-cost, high-performance outdoor gear. Prior to a trip to the Philmont Scout Ranch, he spent time with his patrol looking at materials and designs for outdoor gear at outfitter stores. Eventually, Gihan and two fellow Scouts were so dissatisfied with the performance gear that was on the market that they set out to design their own.

An early prototype was a waterproof fleece vest. Through trial and error, Gihan came up with a vest design that met his needs. Materials selection for the vest's inner layer took him from plastic trash bags to DuPont[™] Tyvek[®], a lightweight waterproof and breathable barrier, popular in the construction industry. The inner layer is thermally laminated to two layers of Polartec[®] fleece. Gihan would use scraps of Tyvek from construction sites or shipping envelopes made of Tyvek when sewing his prototypes.

Remember, inventors are resourceful.



Gihan Amarasiriwardena's vest being used out in the field

Today, Gihan continues to invent. He has interned with a sports engineering company to develop personalized racing shoes using *rapid prototyping* techniques. He continues to develop his own performance apparel and equipment line, Ascendure Mountain Technologies, for climbers and backpackers. “An engineer at heart, and with an appreciation for aesthetics, I love to develop new, innovative solutions that fuse technology and design.” He attends MIT and is studying chemical/biological engineering.

Developing a classic vest meant that Gihan had to learn some new things, like how to sew. While his favorite tool is an MIG welder, the tool that he uses most often is a sewing machine. He learned how to weld and how to sew at his high school. For sewing, he took a class in clothing and textiles.

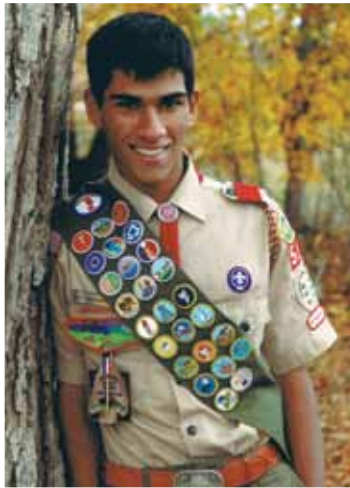

**Inventor Gihan Amarasiriwardena,
Eagle Scout**

to us. I found that with chemical engineering, which is now my major, I could learn how to solve problems and combine my passion for innovation and business.”

How did Gihan Amarasiriwardena decide to major in chemical engineering?

“Scouting has had a huge role in guiding me toward my career goals. In fact, I first learned about chemical engineering through the Personal Management merit badge. One of our objectives was to learn about careers that may be of interest

Feedback Is Key

It is important to get feedback on your idea while it is in development. By showing the intended user or potential customer models of your invention at the beginning of the design phase, their feedback will help you make improvements that will allow you to meet the needs of the user. Then, once you have a prototype, you will be able to seek feedback from users.

Writing down user feedback in your notebook is important. You may want to revisit what they have to say as you move forward with turning your idea into an invention. Remember, an invention has to be useful.

A prototype is a functioning model of a design, concept, or invention.

Models to Rapid Prototyping

Eventually, you will end up with a *prototype* that is very close to a finished invention. Inventors, engineers, and product designers use rapid prototyping to make the final design as quickly as possible. Prototypes may be scaled down in size but they are working models. This allows for a real-world check of the product's functionality before costly manufacturing. Not only does an invention have to be useful, it also has to work.



Removing the smoke stack for a toy train from a 3D printer

A technology that helps inventors, engineers, and product designers with rapid prototyping is *3D printing*. A 3D printer will make a physical model from a 3D CAD design. A 3D printer works much like an inkjet printer. Instead of laying down just one layer of ink on a piece of paper, though, a 3D printer lays down thin layer upon thin layer of material to build up a physical prototype. Since 3D printing is now more affordable, high schools in your community with pre-engineering or technical education programs may have one.



Joshua and Jonathan Marino are playing chess. The board and the pieces were all printed on a 3D printer using ABS plastic. The plastic starts out in a cartridge and looks like grass trimmer line. No color is added; the material is ordered by color. The plastic is about $\frac{1}{32}$ " diameter when in the cartridge. The 3D printer feeds the ABS plastic into the head and melts it down to create a prototype with a 0.010" diameter bead of plastic.

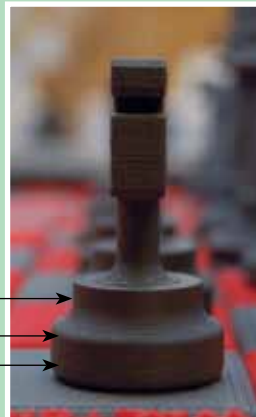

0.010" DIAMETER
BEAD OF PLASTIC
LAYERED TO CREATE
3D PROTOTYPE



Building the Prototype

Taking an invention from an idea to a working prototype is a challenging project and can be a lot of work. You may want to consider putting together a team to jointly conceptualize, design, and build an invention. A team is similar to a patrol in Boy Scouts where **many hands make light work**.

Most inventions are developed by groups of people who all have strengths to bring to the team. Look at U.S. Patent 7,581,715 for the Powered Rope Ascender and Portable Rope Pulling Device. Besides Nathan Ball, there are three other inventors listed: Timothy Fofonoff, Bryan Schmid, and Daniel Walker.

Teenagers can form teams that focus on invention. A Lemelson-MIT InvenTeam from San Juan High School in Blanding, Utah, invented a power-assisted litter device for search and rescue. A volunteer search and rescue team member introduced the problem of backcountry rescues to a group of students in a pre-engineering class at the high school. After working together on a solution, the team defined its invention in this way:

PAL (Power-Assisted Litter) is a single-wheeled, motorized, portable, power-assist device. It is attachable to the majority of types and brands of current rescue litters and is to be used by rescue teams in a variety of terrains and rescue situations around the globe. An electric motor and a gas engine will be available for mine and backcountry rescues. PAL will reduce rescuer fatigue by 30 percent and improve rescue speed by 15 to 30 percent in both mine and backcountry settings, and will reduce the number of people needed by 50 percent for backcountry rescues.

Lemelson-MIT InvenTeams are teams of students, teachers, and mentors who work together to identify real-world problems and then find inventive, technological solutions to these problems. Eight members of the InvenTeam from San Juan High School are Boy Scouts.

An early concept drawing of PAL from October 2007

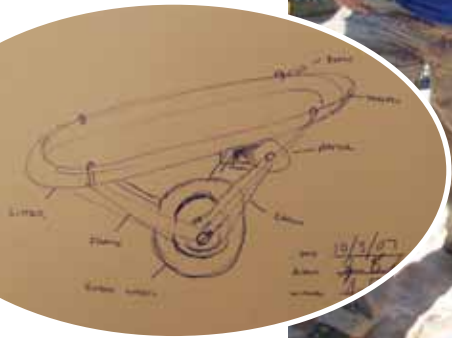

The first thing the young inventors at San Juan High School did was investigate the problem by participating in a mock search and rescue expedition with members of their county's search and rescue team. They asked questions about the rescue process and tested current technologies. They learned from users the limitations and strengths of existing equipment.

Based on interviews with potential users—search and rescue team members—they began to conceptualize and list specifications, or basic things, that the PAL would have to do. This included the speed required, steepness of the hill it could climb, the weight of the person it could carry, how much it should weigh, and how durable it would be. Many times, the specifications changed, based on feedback from intended users.

The expedition was videotaped and viewed by team members. Everyone talked about their experiences and what they learned from the county search team members. The research was documented, specifications were written, and sketches were drawn. CAD models were designed.

In order to prove that the concept would work, a simple model was made combining the best ideas from the sketches. Building began once the model was created. A working prototype was built using thin-walled tubing called conduit for a frame; the front wheel was fashioned from an old tricycle; and a 12-volt battery was hooked to an electric motor with a simple chain drive. Field testing with users indicated necessary design changes.

Since building the initial prototype, three more have been designed, built, and field tested. More than 30 search and rescuers have tested one or more of the prototypes and provided useful feedback. Many things have changed since the original model, including the use of a smaller, lighter wheel; heavier-duty motors; more efficient batteries; hydraulic disk brakes; and a new belt drive. The electronic circuitry is being redesigned to give it variable-speed capability, and a future mine rescue version of PAL is being considered.

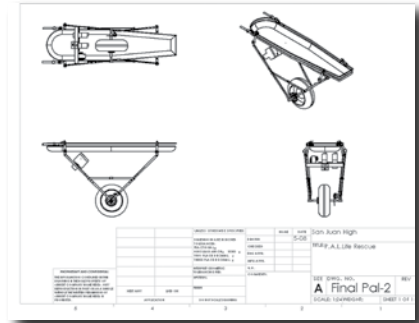

A 2D drawing of second PAL prototype

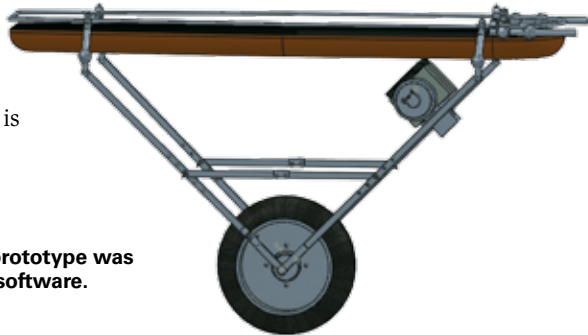

This 3D model of the second PAL prototype was created using SolidWorks 3D CAD software.

Cub Scouts build pinewood derby cars by whittling wood with hand tools. Webelos Scouts learn to use hand tools for their Technology activity badge. Boy Scouts, too, can earn merit badges that require tools. The Automotive Maintenance, Farm Mechanics, Home Repairs, Leatherwork, and Pioneering merit badges all require Scouts to use a variety of tools.

Building an Invention Requires Tools

You cannot build an invention or a working prototype without tools. You may need to find tools and learn how to use them outside the home environment. Perhaps your troop or shop class at school can be a resource. The drama club might have tools and a place to build sets. Or a local high school or school district may have vocational or technical programs offering after-school, evening, and summer enrichment courses in carpentry, machine technology, electronics, and robotics. Your merit badge counselor can help you locate resources.

Students at Brillion High School in Brillion, Wisconsin, are lucky enough to have a modern shop equipped to the hilt. This 10,000-square-foot facility includes a large four-plex processing lab for wood, metal, plastics, and composites, a state-of-the-art design room with computers, computer-numerical controlled machine tools, electronics, robotics equipment, and a 50-student lecture area. The center allows students to work on larger, more complex activities and on integrated projects with other disciplines, such as mathematics and science.

The Design Room of the Brillion High School Ariens Technology Center. Ariens Company Foundation funded the construction of the \$1.5 million Technology and Engineering Education Center for students in Brillion, Wisconsin.



Safety Equipment

With a chest of basic tools, a bench, and a few power tools, you have a workshop. No shop is complete, however, without safety equipment, no matter how basic or how few one's tools may be.

- Safety glasses
- Hearing protection
- Fire extinguisher
- Goggles
- Dust mask
- Gloves



Safety With Tools

Scouts should always take appropriate safety precautions when using tools. Use eye and ear protection; have a fire extinguisher nearby; and do not work with tools without responsible adult supervision. You may have tools at home or have someone associated with your troop who can help you properly and safely learn the use of power tools.

For more information about safety with tools and building materials, see the *Composite Materials*, *Home Repairs*, and *Woodwork* merit badge pamphlets.



Tools for Building

As an inventor, you may eventually want to have your own tools. When purchasing tools, buy the best quality you can afford. Inexpensive screwdrivers are often made with soft metal edges that bend or break under stress. Besides being difficult to work with, they can be unsafe. Tool expert and professional engineer William Gurstelle suggests the following must-have tools and equipment.

- Electric drill, cordless or corded
- Files and brushes (flat and round files, wire brushes)
- Cutters (scissors, wire cutter, utility knife)
- Mixing and volume-measuring equipment
- Hacksaw (for cutting something harder than wood)
- Handsaw (for cutting wood)
- Linear measuring gear (tape measure, protractor, combination square)
- Socket and wrench set (English and metric sockets, Allen wrenches)
- Pliers (standard, needle-nose, locking)
- Hammers (claw hammer and rubber mallet)
- Digital multimeter for electronics projects
- Screwdrivers (assortment of Phillips/cross-headed and plain/flat-headed)
- Scale

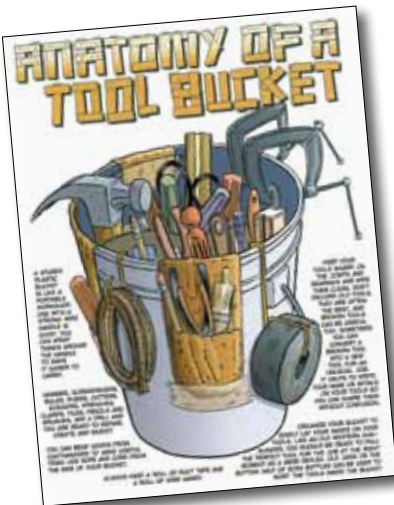

HOWTOONS: *The Possibilities Are Endless!* offers the “Anatomy of a Tool Bucket.”

Power Tools Beyond the Drill

When you have built a basic tool kit, you may decide to add a workbench and a few more useful power tools.

- Belt sander
- Cut-off saw
- Drill press
- Grinder



General Supplies

To complete your workshop, add a few general supplies to make your building easier. Remember that Kettner Griswold built his Trash to Treasure invention with very basic tools and hot glue.

- Tapes (masking, duct, clear adhesive)
- Adhesives (white glue, wood glue)
- Twine and ties
- Sandpaper for metal and wood of various grit
- Markers (pencils and permanent markers)

While this is a complete list of tools, you can get started with just a few tools of your own in a useful bucket. Check out local garage sales. Your bucket need not be new, but sturdy and large enough to carry your tools, supplies, and safety gear.

A soldering iron is a must for electronics projects

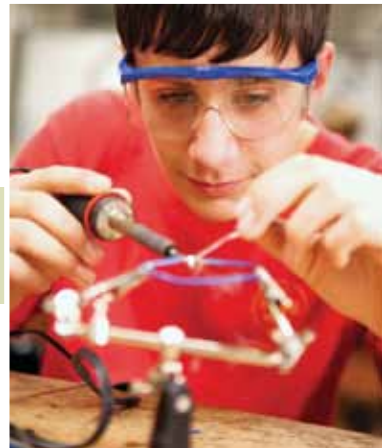

Special tools such as a soldering iron and magnifying lens can be surprisingly handy when you are building a prototype.



Community Resources for Inventors

Inventing need not be a “lone” process. Because we are often inspired by others, getting together with like-minded inventors can prove both enjoyable and useful as you work toward your inventing goals.

Inventing in Your Community

While you can experience the fun of inventing in your community as an independent inventor like Kettner Griswold and his Trash to Treasure invention, you might want to broaden your experience by becoming a member of a team, dedicated to addressing real-world problems with unique, technological solutions. There are many organized after-school opportunities to allow you to combine your knowledge of science, technology, engineering, and math with the ability to build something useful—a combination of inventive thinking and inventive doing. Following are a few excellent opportunities for young inventors.

FIRST

FIRST LEGO League® (FLL) is a team-based competition for youths ages 9 through 14. An annual theme-based challenge, focusing on a current technological or scientific situation, requires teams to build and program LEGO MINDSTORMS® robots. A research project that explores a real-world challenge is required for competitions.



Inventor Dean Kamen

In 2002, Dean Kamen was awarded the \$500,000 Lemelson-MIT Prize for his inventions, particularly his medical technology breakthroughs such as the stair-climbing Independence™ IBOT™ Mobility System, which was revealed in 1999. The IBOT is a battery-powered wheelchair built from sensors, microprocessors, and gyroscopes that can climb stairs and stand upright on two wheels, empowering handicapped people to see and move at eye level. Dean Kamen donated his \$500,000 Lemelson-MIT Prize money to his nonprofit organization, FIRST.

Kamen holds more than 440 U.S. and foreign patents. In 2005, he was inducted into the National Inventors Hall of Fame for his invention of the AutoSyringe®. In 2006, he was awarded the Global

Humanitarian Award by the United Nations. Earlier awards include the National Medal of Technology presented by President Clinton in 2000, the Heinz Award in Technology in 1999, the Hoover Medal in 1995, and the Kilby Award in 1994.



Dean Kamen during the Lemelson-MIT Prize ceremony

FIRST Tech Challenge (FTC) is for young people ages 14 through 18. Small teams of up to 10 youths design, build, and program robots from reusable kits. Awards are given for the robot competition, community outreach, design, and other real-world accomplishments.

FIRST Robotics Competition (FRC) is for those ages 14 through 18. In a highly competitive, sports-like atmosphere, teams of 25 or more build and program robots with time and resource limitations.

FIRST (For Inspiration and Recognition of Science and Technology) was founded by inventor Dean Kamen. With a passion for inventing, he has devoted his career to enhancing human capabilities through technology and innovation and exciting young people about science and engineering.

Destination ImagiNation®

This creative problem-solving program is for participants from elementary school through college. The Destination ImagiNation (DI) program provides competitive team challenges and instant challenges each academic year. Competitions are held at the regional, state, and international levels.

National Engineering Design Challenge

The National Engineering Design Challenge, sponsored by the Junior Engineering Technology Society, is a cross-curricular competition that asks students in grades 9 through 12 to create a useful device to meet the annual challenge. The ultimate goal is for students to discover engineering through real-world applications that impact people and change lives.

eCYBERMISSION

eCYBERMISSION is a free, Web-based science, math, and technology competition for students in grades 6 through 9, who compete for regional and national awards while working to solve problems in their communities. The U.S. Army sponsors eCYBERMISSION with awards for winners, regionally and nationally.

Lemelson-MIT InvenTeams

The Lemelson-MIT InvenTeam initiative is the premier national grants initiative for inventive high school students. Teams of students and mentors receive grants of up to \$10,000 each to conceptualize, design, and build technological solutions to real-world problems. Projects are collaborative efforts, driven by the students. InvenTeams research intellectual property issues, design parts, build models, and make modifications as they develop prototypes of their inventions. InvenTeams showcase their prototypes each June at MIT.



Inventor and Life Scout Eric Peek is a member of the Oak Ridge High School InvenTeam. Here, he works with a 6-inch PVC pipe in a stream that supplies water to a waterwheel, which in turn powers a microscale hydroelectric water treatment device. Eric is a member of Troop 129, Great Smoky Mountains Council, in eastern Tennessee.

Museums Dedicated to Inventions

Inventors live in all types of communities. You can find them in urban, suburban, and rural areas. One way to find inventors who have been important to your community is through your local historical society. There may be a museum nearby that highlights technologies and inventors.

The **3M Museum** is operated by the Lake County Historical Society in Two Harbors, Minnesota. The small museum is located in Two Harbors because the founders of 3M (Minnesota Mining and Manufacturing Company) found a mineral there in the early 1900s that they thought could be used for making sandpaper. The museum highlights the importance of research and development, product diversification, and growth of a company through innovation.

The **Cyrus McCormick Farm** is located at the Shenandoah Valley Agricultural Research and Extension Center in rural Steeles Tavern, Virginia. McCormick, the father of modern agriculture, invented the first successful mechanical reaper in 1831 when he was in his early 20s. The reaper was the beginning of a new industry of mechanical harvesting and made significant contributions to American prosperity.



McCormick's invention is on display at his ancestral home, Walnut Grove Farm (now called Cyrus McCormick Farm), in Steeles Tavern, Virginia.

Highlighting Invention at Museums

The **Bakken Library and Museum** in Minneapolis, Minnesota, collects artifacts related to the history of electricity and magnetism in medicine. Young inventors are supported through its Inventors Club.

The **Exploratorium** in San Francisco is a hands-on science center with a Tinkering Studio for the community.

The **Franklin Institute Science Museum** in Philadelphia, Pennsylvania, focuses on science and technology learning.

The **Henry Ford Museum** in Dearborn, Michigan, offers educational programs and exhibits based on the life of Henry Ford.

The **Jerome and Dorothy Lemelson Center for the Study of Invention and Innovation** is located in the Smithsonian Institution's National Museum of American History in Washington, D.C.

From the Wright Flyer to the SR-71

The 1903 *Wright Flyer* and a Lockheed SR-71 *Blackbird* are both part of the Smithsonian Institution's collection of historically significant airplanes. The *Wright Flyer* was the first powered airplane that made a 12-second flight and traveled 120 feet. Sixty-one years later, the *Blackbird*, a high-speed, high-altitude reconnaissance airplane, made its first flight and continued in service for more than 20 years.

The 1903 *Wright Flyer*

When one of the last *Blackbirds* was retired to the Smithsonian Institution in 1990, it flew from Los Angeles, California, to Washington, D.C., at a record-setting speed by crossing the United States in 1 hour, 4 minutes, and 20 seconds averaging 2,124 miles per hour. From the *Wright Flyer* to the *Blackbird*, air transportation has been made possible by skilled engineers, advances in materials science, and innumerable inventions.



The Lockheed SR-71 *Blackbird*

The **MIT Museum** in Cambridge, Massachusetts, offers insights to the foundations of science and technology.

The **Museum of Science** in Boston, Massachusetts, focuses on the importance of science for individuals and society.

The **Museum of Science and Industry** in Chicago, Illinois, offers hands-on interactive exhibits including one on inventing the future.

The **New York Hall of Science** in Queens, New York, focuses on science and technology with hands-on exhibits, events, and programs.

The **Oregon Museum of Science and Industry** in Portland, Oregon, focuses on science and technology.

The **Science Museum of Minnesota** in St. Paul has an Invention Playhouse to stimulate inventive thinking.

The **Smithsonian National Air and Space Museum** in Washington, D.C., houses airplanes and spacecraft with historical significance.

The **Tech Museum** in San Jose, California, focuses on science and technology.



Each museum listed has an extensive Web page that lists the exhibits and special programs available to Boy Scouts and their families. Even if you cannot visit the museums in person, with your parent's permission, use your favorite search engine to find their Web sites. You can virtually explore concepts to build your knowledge of science and technology that will be useful to you as an inventor.



Inventing As a Career

Earning your Eagle Scout rank takes years of preparation just as being an accomplished athlete requires years of training. These accomplishments do not happen by accident. Nor does becoming an inventor happen by accident. Building your academic and technical foundation will greatly help you prepare for your journey of inventive thinking and doing.

Eureka!

The word “eureka” is commonly attributed to Archimedes, the Greek inventor and mathematician famous for Pi, when he realized an answer to a problem that seemed impossible to answer.

The king wanted Archimedes to determine if his new crown was made of pure gold—as specified—or of a cheaper alloy. Archimedes knew the mass of the crown. If he could determine the volume of the irregularly shaped crown, he could calculate the density by *dividing the mass by the volume*. Thus, he could compare the crown’s density to that of pure gold. As the story goes, he discovered how to determine the volume when getting into a bath and displacing the water. This illustrative story about breakthrough thinking and a *Eureka!* moment has endured over time.

Preparing to be inventive begins with the toys you play with and the classes you take in school. Choosing classes that help you become more aware of your world will benefit you as an aspiring inventor. Math and science are important for working on your experimental and problem-solving skills. English helps you communicate your ideas to others. Art classes help you develop creativity and imagination.

Inventors are leaders. They recognize problems in their world and seek solutions. They bring together resources—people, materials, money—to build appropriate solutions.

Biologists can
be inventors.
So can chemists,
engineers,
auto technicians,
nurses, and
cross-country
skiers.



In addition to your everyday school work, preparation comes from the activities you choose. Extracurricular activities that stretch you outside of your normal comfort zone are important for real-life problem solving.

Consider joining a science club, math team, or robotics program. Being part of a drama club will help you develop confidence in presenting yourself and your good ideas. The key is to find something you love and throw yourself into it. When Isaac Newton was asked how he made so many great discoveries, he said, “By thinking about it night and day.” Thinking about math, science, and English will help you apply and integrate concepts in unique ways.

Be curious and observe the world around you. Never stop wondering **WHY** or asking “**What if . . .**” questions. Inventors are not trapped by what they know or don’t know; they are flexible thinkers and can find their own answers. Inventors have certain traits that you may want to develop. They are persistent; they work through and learn from failures; they are comfortable working with complexity and ambiguity; and they are comfortable dealing with answers that aren’t necessarily right or wrong.

Does a young person decide to become an inventor and then study to become one? Not usually. People develop inventive skills over time while they are also becoming profoundly **knowledgeable about their area of work or interest**. Biologists can be inventors. So can chemists, engineers, auto mechanics, nurses, and cross-country skiers, like John Fabel. All career fields can benefit from inventive thinking, particularly when the objective is to solve a real-world problem with a technological solution.

Inventions do not come easily. Thomas Edison, one of the greatest inventors of all time, recognized the value of hard work. In the end, great inventions happen because great inventors work hard. Doing your best in school and your other activities may be the best way to **BE PREPARED** to be inventive.

“Opportunity is missed by most people because it is dressed in overalls and looks like work.”

—Thomas A.

Edison, inventor





Glossary

2D. Two dimensions.

2D CAD. Software used to create two-dimensional models.

3D. Three dimensions.

3D CAD. Software used to create three-dimensional models.

3D printing. Technology for creating physical models (prototypes) by building up layers of material.

3-view drawing. A 2D drawing that provides three views of a model: Front, Top, and Right Side views.

algorithm. A predetermined set of instructions for solving a specific problem in a limited number of steps.

breadboard. A reusable thin plastic board for prototyping electronic circuits.

CAD. Computer-aided design.

computer-aided design. The use of computer software to create 3D models.

copyright. The exclusive right to the publication, production, or sale of the rights to a literary, dramatic, musical, or artistic work, or to the use of a commercial print or label, granted by law for a specified period of time to an author, composer, artist, distributor, etc.

crystal set. A primitive type of radio receiver with a crystal detector instead of an electron tube detector.

design. To plan and carry out, especially by artistic arrangement or in a skillful way.

design patent. Granted to anyone who invents a new, original, and ornamental design for an article of manufacture.

division of labor. A sequential system of manufacture and assembly whereby each worker focuses on a specific task, which they repeat, instead of assembling the entire product.

engineering. The profession using science and technology to meet the needs of people; some specialties in engineering are civil, mechanical, software, chemical, aerospace, and biomedical.

entrepreneurship. The act of being an entrepreneur; an entrepreneur is someone who turns an idea into a new business venture.

eureka. Loosely translated as “I have found (it)”; an exclamation supposedly uttered by Archimedes when he discovered a way to determine the purity of gold by applying the principle of specific gravity.

intellectual property. Ideas and expressions of the human mind considered unique and original and to be worth money in the marketplace—and deserving of protection under the law. These include patents, trademarks, and copyrights.

innovation. The complex process of introducing new ideas into use and practice, primarily through entrepreneurship.

inventing. The process of coming up with and making—through independent investigating, experimenting, and thinking—something that is useful and that was not previously known or created.

invention. The product of the inventing process, which can encompass many things, ranging from devices and machines to political systems and organizational structures.

inventiveness. The form of creativity that results in an invention.

macroinventions. Inventions of such sizable impact that they change the way people live.

microchip. A semiconductor body in which an integrated circuit is formed.

microinventions. Improvements made to existing inventions.

monolithic integrated circuit. An electronic circuit containing many interconnected amplifying devices and circuit elements formed on a single body, or chip, of semiconductor material.

nanoparticles. Micro-miniature particles created by manipulating atoms and molecules as if they were parts of a machine.

open source. Commonly refers to a computer software that anyone can use without purchasing a license or paying a fee to the inventor or distributor; open source is gaining traction in hardware. Open source provides a rich learning environment to develop skills and understanding about how technology works.

parametric modeling. A system of CAD in which the parameters of a model are mathematically linked, enabling automated changes to all parameters associated with a single change.

patent. The right to exclude others from producing, selling, or realizing a profit from an invention or process for a specific number of years.

patent infringement. When someone tries to benefit commercially from a patented item or uses it without licensing it from the patent owner.

plant patent. Granted to someone who invents or discovers, and asexually reproduces, any distinct or new variety of plant.

prototype. A working model of a design, concept, or invention.

rapid prototyping. Any technology that enables the production, creation, or manufacture of a physical model quickly and inexpensively.

routine problem solving. Developing solutions to problems that have specific and predictable results.

technological solution. The physical product of the inventing process, such as machines, devices, materials, processes, algorithms, and databases.

trademark. A symbol, design, word, brand name, letter, slogan, etc., that is used by a manufacturer or dealer to distinguish a product or products from those of competitors.

unique. The one and only; single; sole; having no like or equal; unparalleled; highly unusual; extraordinary; rare; etc.

utility patent. Granted to someone who invents or discovers a new and useful process, machine, article of manufacture, or composition of matter, or any new and useful improvement thereof—the most common type of patent.



Inventing Resources

Scouting Literature

American Business, American Labor, Architecture and Landscape Architecture, Composite Materials, Drafting, Electronics, Engineering, Entrepreneurship, Home Repairs, Metalwork, Model Design and Building, and Woodwork merit badge pamphlets

Visit the Boy Scouts of America's official retail Web site (with your parent's permission) at <http://www.scoutstuff.org> for a complete listing of all merit badge pamphlets and other helpful Scouting materials and supplies.

Books

- Anderson, Maxine. *Amazing Leonardo da Vinci Inventions You Can Build Yourself*. Nomad Press, 2006.
- Boy Scouts of America. *Boy Scouts Handbook, The First Edition, 1911*, reprint. Dover Publications, 2005.
- Brown, David E. *Inventing Modern America: From the Microwave to the Mouse*. MIT Press, 2002.
- Brown, Travis. *Popular Patents America's First Inventions From the Airplane to the Zipper*. The Scarecrow Press, 2000.

- Carson, Mary Kay. *The Wright Brothers for Kids*. Chicago Review Press, 2003.
- Griffith, Saul, Nick Dragotta, and Joost Bonsen. *Howtoons: The Possibilities are Endless*. HarperCollins Publishers, 2007.
- Macaulay, David, and Neil Ardley. *The New Way Things Work*. Houghton Mifflin Company, 1998.
- Robinson, James. *Inventions*. Kingfisher, 2006.
- Sobel, Dava, and William J. H. Andrewes. *The Illustrated Longitude*. Walker and Company, 1998.
- Woodford, Chris, James Flint, Ben Morgan, Clint Witchalls, and Luke Collins. *Cool Stuff and How It Works*. DK Publishing Inc., 2005.

Periodicals

Make

Web site: <http://makezine.com>

Inventors Digest

Web site: <http://www.inventorsdigest.com>

Organizations and Web Sites

Design Squad

Web site: <http://pbskids.org/designsquad>

FreePatentsOnline

Web site: <http://www.freepatentsonline.com>

Howtoons

Web site: <http://www.howtoons.com>

This do-it-yourself comic Web site with tools of mass construction includes fun projects.

**Lemelson-MIT Program
Massachusetts Institute of
Technology**

Web site: <http://web.mit.edu/invent>

The program recognizes outstanding inventors, encourages sustainable new solutions to real-world problems, and enables and inspires young people to pursue creative lives and careers through invention. The program is funded by the Lemelson Foundation and administered by the Massachusetts Institute of Technology.

OpenCourseWare

Web site: <http://ocw.mit.edu>

A special section, “Highlights for High School,” features materials useful for students and their teachers.

SolidWorks®

Web site: <http://www.solidworks.com>

Free trial software is available for Boy Scouts.

U.S. Patent and Trademark Office

Web site: <http://www.uspto.gov>

Acknowledgments

The Boy Scouts of America thanks the Lemelson-MIT Program and Dassault Systèmes SolidWorks Corporation for

their support in the development of the new Inventing merit badge and production of the inaugural edition of the *Inventing* merit badge pamphlet.



LEMELSON • MIT PROGRAM

celebrating innovation, inspiring youth

Photo and Illustration Credits

Gihan Amarasiriwardena, courtesy—pages 66–67 (*both*)

Jared Berrett, courtesy—cover (*top right*); pages 60–61 (*both*), 62 (*top*), and 72–73 (*all*)

Edward Byrnes, courtesy—page 74

The Coleman Company, courtesy—pages 42 (*both*) and 50–51 (*all*)

Comstock—pages 12, 36, and 58 (*top*)

Dassault Systèmes SolidWorks Corporation, courtesy—cover (*iPod docking station*); pages 25 (*iPod docking station*), 62 (*bottom*), and 93

DataDyne.org, courtesy—page 47

Sara DeSalvo, courtesy—pages 68–69 (*all*)

George Doyle—page 24 (*car*)

Nick Dragotta—pages 28–29 (*bridge illustration*) and 52

Eureka Lab Book Inc., courtesy—pages 54 and 55

Larry Ewing and The GIMP (General Image Manipulation Program), courtesy—page 45

The vision for this merit badge and much of the content for the *Inventing* merit badge pamphlet was provided by Boy Scouts from across the country, many of whom are young inventors. In addition to Boy Scouts, many people from university laboratories, high schools, museums, and corporations gave freely of their time and resources to make this merit badge a reality because they believe in the inventive spirit.

- John Fabel, courtesy (illustration by Steve Johnson)—page 29 (*backpack*)
- John Fabel/Lemelson Center/National Museum of American History, Smithsonian Institution, courtesy—page 29 (*John Fabel*)
- FLL Team 1044, Lexington, Massachusetts, courtesy—page 79
- Ford Motor Company, courtesy—page 21 (*both*)
- Freepatentsonline.com—page 26
- John Foxx—page 24 (*bike*)
- Global Cycle Solutions, courtesy—page 44
- Google.com/patents—page 35 (*top*)
- Kettner Griswold, courtesy—page 64 (*both*)
- William Gurstelle, courtesy—pages 75, 76 (*top*), and 77 (*top*)
- HarperCollins Publishers, used by permission—page 76 (*bottom*)
- Hemera Technologies—pages 16, 18 (*crank electric bulb*), and 48 (*folding chair*)
- John Hilliard, courtesy—page 46
- Jupiterimages—pages 4, 18 (*“smart” phone, world globe bulb*), 19, 34, 48 (*tent and bottom right*)
- Kansas State Historical Society, courtesy—pages 14–15
- The Leatherman Tool Company, courtesy—cover (*top left*); pages 53, 57 (*left*), and 63 (*top*)
- Lemelson-MIT Program, courtesy—pages 3, 30–32 (*all*), 40 (*bottom*), 54 (*top*), 77 (*bottom*), 80, 82, 85, and 88
- Eric Long, National Air and Space Museum, Smithsonian Institution (SI 94-2311), courtesy—page 63 (*bottom*)
- Eric Long and Mark Avino, National Air and Space Museum, Smithsonian Institution (SI 2000-9346), courtesy—page 63 (*bottom*)
- PhotoObjects.net—page 18 (*antique phone*)
- Segway Inc, courtesy—cover (*Segway® Personal Transporter*); page 10
- Jessica Erin Simpson, courtesy—pages 39, 86 (*bottom*), and 90
- Stockbyte—pages 18 (*microscope*) and 24 (*center right*)
- Terrafugia Inc., courtesy—cover (*Transition aircraft*); pages 6–7 (*both*), 17, and 33
- Texas A&M University Racing Team/Dassault Systèmes SolidWorks Corporation, courtesy—page 89
- Texas Instruments Inc., courtesy—pages 22 (*both*), and 23
- U.S. Library of Congress Prints and Photographs Division—page 84 (*top*)
- U.S. Library of Congress/Wikipedia.org—page 20
- U.S. Patent and Trademark Office—page 39 (*top*)
- Uspatentoffice.com—page 35 (*bottom*)
- Virginia Agricultural Experiment Station, courtesy—page 83
- Sam Wallander, courtesy—pages 8, 43, 56, 70, 78, and 86 (*two top*)
- Wikipedia.org—pages 13 and 40 (*top*)
- Zedcor Wholly Owned—page 48 (*picnic backpack*)
- All other photos and illustrations not mentioned above are the property of or are protected by the Boy Scouts of America.
- Brian Payne—page 24 (*top right*)

MERIT BADGE LIBRARY

Though intended as an aid to Boy Scouts, Varsity Scouts, and qualified Venturers in meeting merit badge requirements, these pamphlets are of general interest and are made available by many schools and public libraries. The latest revision date of each pamphlet might not correspond with the copyright date shown below, because this list is corrected only once a year, in January. Any number of merit badge pamphlets may be revised throughout the year; others are simply reprinted until a revision becomes necessary.

If a Scout has already started working on a merit badge when a new edition for that pamphlet is introduced, *he may continue to use the same merit badge pamphlet to earn the badge and fulfill the requirements therein.* In other words, the Scout need not start all over again with the new pamphlet and possibly revised requirements.

Merit Badge Pamphlet	Year	Merit Badge Pamphlet	Year	Merit Badge Pamphlet	Year
American Business	2002	Engineering	2008	Photography	2005
American Cultures	2005	Entrepreneurship	2006	Pioneering	2006
American Heritage	2005	Environmental Science	2006	Plant Science	2005
American Labor	2006	Family Life	2005	Plumbing	2004
Animal Science	2006	Farm Mechanics	2008	Pottery	2008
Archaeology	2006	Fingerprinting	2003	Public Health	2005
Archery	2004	Fire Safety	2004	Public Speaking	2002
Architecture	2008	First Aid	2007	Pulp and Paper	2006
Art	2006	Fish and Wildlife		Radio	2008
Astronomy	2004	Management	2004	Railroading	2003
Athletics	2006	Fishing	2009	Reading	2003
Automotive Maintenance	2008	Fly-Fishing	2009	Reptile and	
Aviation	2006	Forestry	2005	Amphibian Study	2005
Backpacking	2007	Gardening	2002	Rifle Shooting	2001
Basketry	2003	Genealogy	2005	Rowing	2006
Bird Study	2005	Geology	2005	Safety	2006
Bugling (see Music)		Golf	2002	Salesmanship	2003
Camping	2005	Graphic Arts	2006	Scholarship	2004
Canoeing	2004	Hiking	2007	Scuba Diving	2009
Chemistry	2004	Home Repairs	2009	Sculpture	2007
Cinematography	2008	Horsemanship	2003	Shotgun Shooting	2005
Citizenship in the		Indian Lore	2008	Skating	2005
Community	2005	Insect Study	2008	Small-Boat Sailing	2004
Citizenship in the Nation	2005	Journalism	2006	Snow Sports	2007
Citizenship in the World	2005	Landscape Architecture	2008	Soil and Water	
Climbing	2006	Law	2003	Conservation	2004
Coin Collecting	2008	Leatherwork	2002	Space Exploration	2004
Collections	2008	Lifesaving	2008	Sports	2006
Communication	2009	Mammal Study	2003	Stamp Collecting	2007
Composite Materials	2006	Medicine	2009	Surveying	2004
Computers	2009	Metalwork	2007	Swimming	2008
Cooking	2007	Model Design and Building	2003	Textile	2003
Crime Prevention	2005	Motorboating	2008	Theater	2005
Cycling	2003	Music and Bugling	2003	Traffic Safety	2006
Dentistry	2006	Nature	2003	Truck Transportation	2005
Disabilities Awareness	2005	Nuclear Science	2004	Veterinary Medicine	2005
Dog Care	2003	Oceanography	2009	Water Sports	2007
Drafting	2008	Orienteering	2003	Weather	2006
Electricity	2004	Painting	2008	Whitewater	2005
Electronics	2004	Personal Fitness	2006	Wilderness Survival	2007
Emergency Preparedness	2008	Personal Management	2003	Wood Carving	2006
Energy	2005	Pets	2003	Woodwork	2003

BOY SCOUTS OF AMERICA • SUPPLY GROUP

NATIONAL DISTRIBUTION CENTER

2109 Westinghouse Boulevard
P.O. Box 7143
Charlotte, NC 28241-7143

www.scoutstuff.org

DIRECT MAIL CENTER

P.O. Box 909
Pineville, NC 28134-0909
For fast credit card orders—

VISA, MasterCard, American Express—
call BSA operators toll-free
1-800-323-0732



EAGLE SCOUT



FLORIDA SEA BASE



PHILMONT SCOUT RANCH



NORTHERN TIER

ON THE ROAD TO HIGH ADVENTURE

THE SUPPLY GROUP IS
READY TO BE A PARTNER
ON YOUR TRAIL TO
EAGLE THROUGH HIGH
ADVENTURE. THE
ADVENTURE IS YOURS,
AND WE ARE READY
WITH THE GEAR YOU
WILL NEED. YOU CAN
DEPEND ON THE LATEST
IN LIGHTWEIGHT,
DURABLE, QUALITY
GEAR THAT WILL
MEET AND SURPASS
YOUR TOUGHEST
REQUIREMENTS.



WWW.SCOUTSTUFF.ORG

SKU 610462



7 30176 35833 8
35833 2010 Printing