

MERIT BADGE SERIES

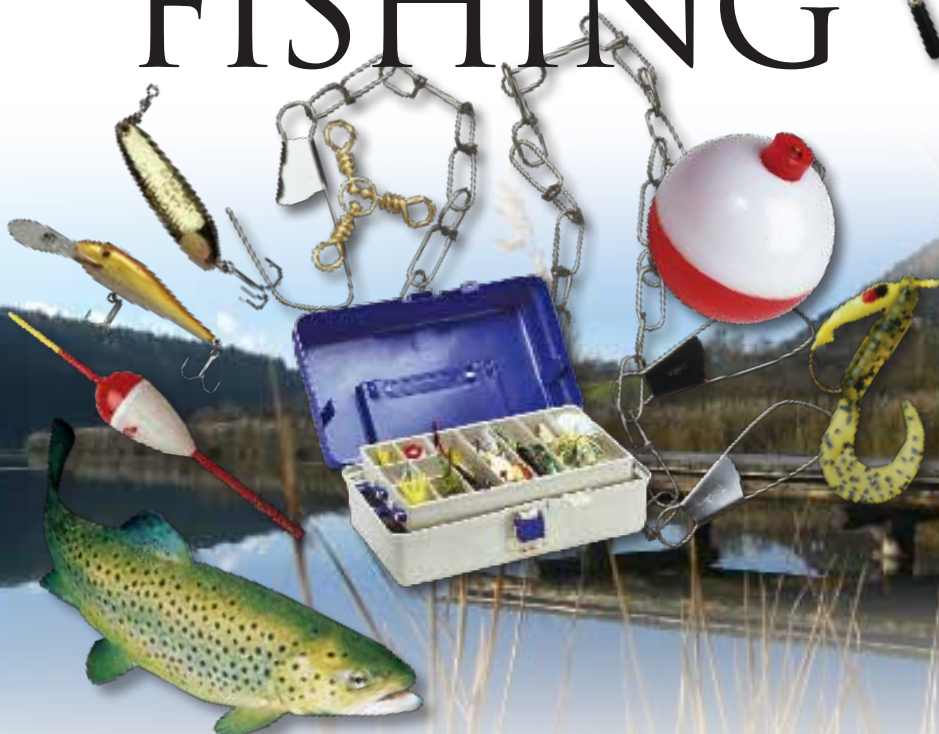

FISHING



BOY SCOUTS OF AMERICA®



HOW TO USE THIS PAMPHLET

The secret to successfully earning a merit badge is for you to use both the pamphlet and the suggestions of your counselor.

Your counselor can be as important to you as a coach is to an athlete.

Use all of the resources your counselor can make available to you.

This may be the best chance you will have to learn about this particular subject. Make it count.

If you or your counselor feels that any information in this pamphlet is incorrect, please let us know. Please state your source of information.

Merit badge pamphlets are reprinted annually and requirements updated regularly. Your suggestions for improvement are welcome.

Send comments along with a brief statement about yourself to Youth Development, S209 • Boy Scouts of America • 1325 West Walnut Hill Lane • P.O. Box 152079 • Irving, TX 75015-2079.

WHO PAYS FOR THIS PAMPHLET?

This merit badge pamphlet is one in a series of more than 100 covering all kinds of hobby and career subjects. It is made available for you to buy as a service of the national and local councils, Boy Scouts of America. The costs of the development, writing, and editing of the merit badge pamphlets are paid for by the Boy Scouts of America in order to bring you the best book at a reasonable price.



BOY SCOUTS OF AMERICA
MERIT BADGE SERIES

FISHING



BOY SCOUTS OF AMERICA®

Requirements

1. Do the following:
 - a. Discuss the prevention of and treatment for the following health concerns that could occur while fishing, including cuts and scratches, puncture wounds, insect bites, hypothermia, dehydration, heat exhaustion, heatstroke, and sunburn.
 - b. Explain how to remove a hook that has lodged in your arm.
 - c. Name and explain five safety practices you should always follow while fishing.
2. Discuss the differences between two types of fishing outfits. Point out and identify the parts of several types of rods and reels. Explain how and when each would be used. Review with your counselor how to care for this equipment.



3. Demonstrate the proper use of two different types of fishing equipment.
4. Demonstrate how to tie the following knots: clinch, Palomar, turle, blood loop (barrel knot), and double surgeon's loop. Explain how and when each knot is used.
5. Name and identify five basic artificial lures and five natural baits and explain how to fish with them. Explain why baitfish are not to be released.



6. Do the following:
 - a. Explain the importance of practicing Leave No Trace techniques. Discuss the positive effects of Leave No Trace on fishing resources.
 - b. Discuss the meaning and importance of catch and release. Describe how to properly release a fish safely to the water.
7. Obtain and review the regulations affecting game fishing where you live. Explain why they were adopted and what is accomplished by following them.
8. Explain what good outdoor sportsmanlike behavior is and how it relates to anglers. Tell how the Outdoor Code of the Boy Scouts of America relates to a fishing sports enthusiast, including the aspects of littering, trespassing, courteous behavior, and obeying fishing regulations.
9. Catch at least one fish. If regulations and health concerns permit, clean and cook a fish you have caught. Otherwise, acquire a fish and cook it.



Contents

| | |
|---|----|
| Introduction | 6 |
| The Nature of Fish | 9 |
| Freshwater Fish. | 23 |
| Saltwater Fish | 35 |
| Balanced Tackle. | 39 |
| Fishing Gear and Craft. | 62 |
| Safety Practices | 69 |
| Cleaning, Filleting, and Cooking Fish | 76 |
| Protecting Game Fish Resources. | 81 |
| Glossary | 92 |
| Fishing Resources | 94 |

Introduction

This pamphlet will tell you a lot about fish and how to catch them. You might catch them for fun and “sport,” or to eat. Fishing can become a lifetime pursuit, like golf or tennis. Many kinds of fish are described here, along with many ways to catch them—there are always new challenges in fishing, and always more to learn. This is one merit badge you are sure to enjoy earning from the very start.

As for beginnings, fishing has a long and interesting history. As soon as early humans discovered that there were fish in the waters and that the fish were good to eat, they began to devise methods for catching those fish. They quickly found that it was easier to spear fish than to grab them with their hands. Later, they discovered that they could catch even more fish by using woven nets.

After observing fish while they were feeding, these early peoples began making sport of catching fish by putting a sliver of bone inside a bait with a thong fastened to the middle of the bone. When the fish grabbed the bait and swallowed it, the piece of bone caught crosswise inside the fish, allowing it to be pulled in. This birth of angling, long before humans began recording history, led to the invention of fishhooks, made first of bone and later of metal.

The initial intent of catching fish was to get food. However, even early humans found that trying to outwit a fish with a line and bait was an intriguing pursuit with considerable excitement when a big fish latched on to the hook. Eventually, fishing evolved into a sport, and anglers devised finer, lighter **tackle**, making it more challenging to hook a fish and giving the fish an opportunity to beat anglers at their own game. Thus was born the sport of fishing, distinct from commercial fishing or fishing for food.





Baden-Powell's Love of Fishing

Robert S. S. Baden-Powell, the founder of the Scouting movement, claimed fishing as one of his favorite pastimes. As the Chief Scout of the growing Scouting movement during the early 20th century, Lord Baden-Powell traveled the world to attend jamborees and provide leadership and inspiration. Everywhere he went, his fishing rods, reels, and fishing kit went with him. Baden-Powell's biographer E. E. Reynolds wrote, "When he needed to get right away from everything and everybody, he would go off for a few days' fishing."

In *Scouting for Boys*, Baden-Powell offers this advice to the young fisherman: "Every Scout ought to be able to fish in order to get food for himself. A tenderfoot [beginner] who starved on the bank of a river full of fish would look very silly, yet it might happen to one who had never learned to catch fish."

It's no surprise that fishing remains a favorite pastime on Scout outings.

In his book *Lessons From the Varsity of Life*, Baden-Powell declares, "Trout fishing is the best rest-cure in the world."



The Nature of Fish

Fish are highly specialized aquatic creatures, amazingly constructed for living in water. Here are some interesting facts about fish.

- They are cold-blooded—their body temperature is about the same as the water around them.
- Not all fish have scales, but all fish are covered with a thin skin.
- Scales are protective plates that are covered by the skin. When a scale is lost, its “pocket” can become infected before the skin heals over and a new scale develops.
- Scales develop annual rings much like those of a tree. A fish’s scales can help determine its age.
- The muscles and fins of fish are designed to propel them through the water in search of food and to help them escape from enemies.
- Fish breathe mainly through gills that take oxygen from the water and send it into the bloodstream while simultaneously removing carbon dioxide from the fish.

Most fish reproduce by the female laying eggs that the male fertilizes in the water. The females of some species may lay millions of eggs, while some other species lay only a few hundred. Fish have the senses of sight, taste, smell, hearing, and touch, as well as other special senses to help them survive.

Some fish species are especially smart. Any experienced angler who has tried to catch the “old lunker” that has lived in the same pool for years will swear to that.

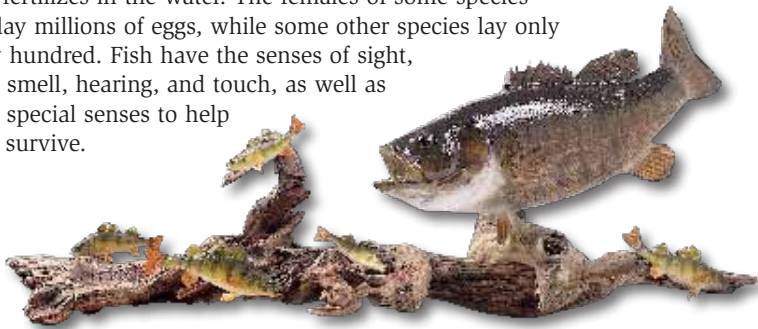

Parts of a Fish

Anal fin. Used for balance and swimming.

Caudal fin. Used in swimming, particularly when a fish needs a quick thrust of speed.

Eye. Most fish have monocular vision—each eye sees separately, offering a wide field of view.

Gills. Respiratory organs used for breathing.

Jaws. Bony appendages that form a fish's mouth. They may be equipped with teeth so that a fish can grip its prey while feeding.

Lateral line. A sensory organ that detects sound and movement.

Pectoral fin. Used for stability, locomotion, and steering.

Pelvic fin. Used for steering and stability.

Scales. Transparent protective plates growing from the skin that can be replaced if lost.

Soft dorsal fin. Used for balance and forward movement.

Spiny dorsal fin. The forward fin, supported by sharp spines, is used for balance. The spines also protect the fish from its enemies.

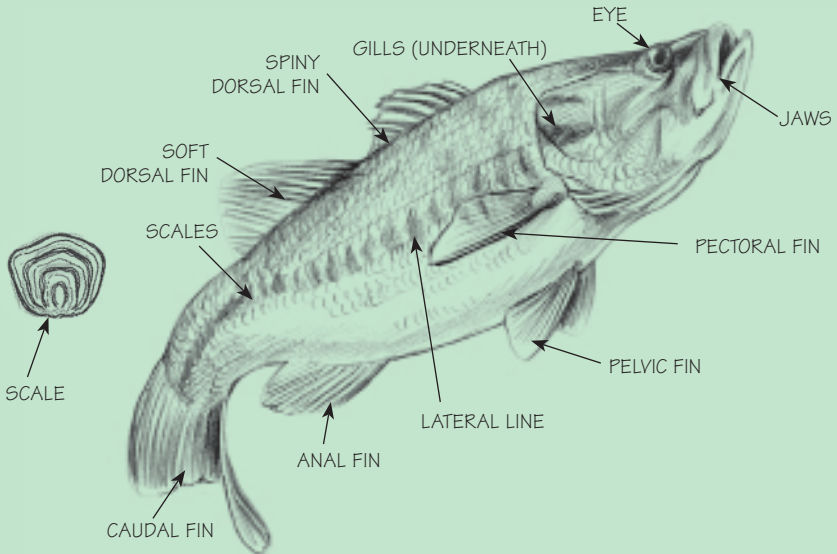

Toothy Fish

Beware! Some common fish that you may catch, like the pike and pickerel in ponds, or bluefish in salt water, have very sharp teeth. Do not “land” them by grasping their mouth. Their teeth are there for snatching their prey—not your fingers.



The Food Chain

As you practice the sport of fishing, you will learn about the watery world of fish, a complex environment that provides the food fish eat. At the bottom of the chain are plankton—minute creatures that are eaten by other forms of aquatic life, including some of the fish. In freshwater, there are countless insects that creep, crawl, and live in the water, eventually climbing or flying out of the water to mate, drop their eggs, and start another cycle of life. Fish and other creatures feed on these insects.





Large predator fish may eat insects, frogs, crayfish, and other fish—even members of their own families.

Crayfish hide under rocks and eat anything alive or dead they come across. Tadpoles swim in the shallows, developing into frogs that live on the shorelines. Small fish, including minnows, eat smaller forms of aquatic life and in turn are eaten by larger forms. The lures you use will imitate these forms of food.

The food chain starts with the smallest being eaten by larger creatures. In turn, those critters are eaten by something else. At the top of the chain are fish and the creatures that feed upon fish, including eagles, ospreys, mink, otters, bears, and, of course, humans.

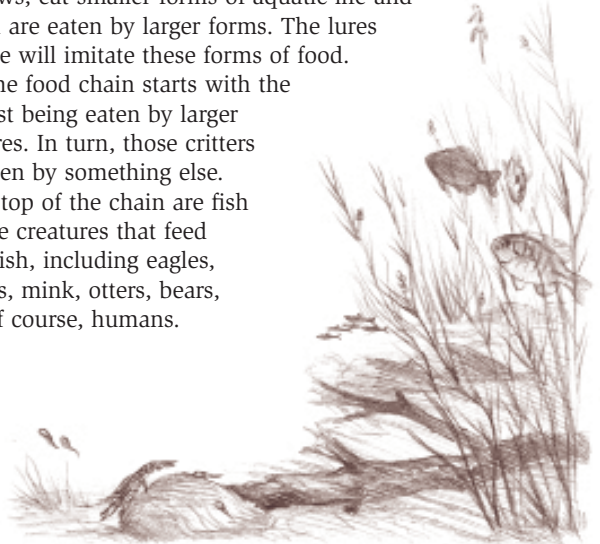

Reading Nature's Signs

Locating lakes and streams where there are fish is easy. Every state conservation department has lists or maps showing all the fishing waters and which types of fish are in them. Tackle shops, sporting magazines, and friendly anglers are your most convenient sources of information on where to fish. Don't be shy in asking for information about local fishing spots. But once on the water, where are the fish?



Fish feed on insect larvae year-round. Larvae are the mainstay of their diet.

Fish Movement

Game fish often come to the surface, sometimes leaping clear out of the water for food. The experienced angler searches for signs as to how a fish is feeding—whether a fish is surfacing or seeking food just beneath the surface. The angler is alert to the flash of sun on scales underwater or to the movement of a fish's shadow.

Insect Activity

Insect life hatches continually year-round. The appearance of insects such as mayflies and caddis flies indicates that an abundance of larvae is crawling and swimming below, which means that fish are probably feeding on them.



Where to Find Fish

Fish can be found just about anywhere there is clean water. Fish live in bodies of water as small as a pond or as large as the ocean.

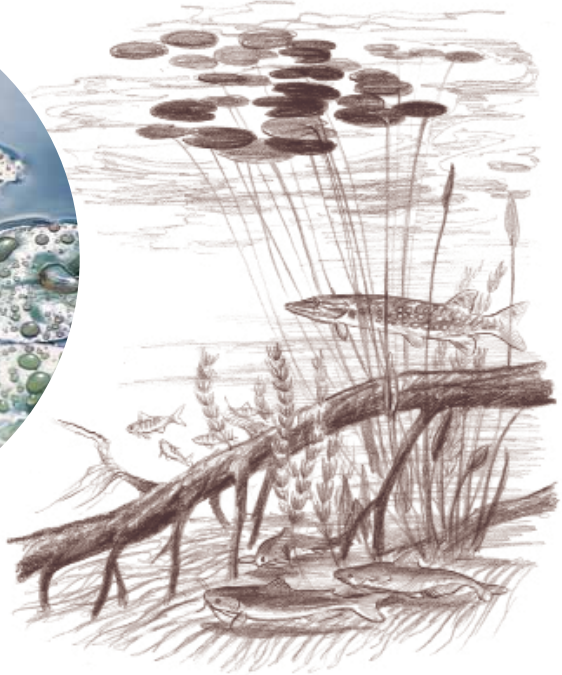

A pond can have many species of fish at all depths.

Some pond owners plant lily pads or other vegetation to provide shade, cover, and places for fish to congregate so they will be easier to catch.

Ponds

Properly managed ponds can be high producers of fish, providing excellent angling. Most ponds contain game fish such as bluegills and largemouth bass along the shoreline, adjacent to weed cover, or in the colder deep waters. Ponds are relatively easy to fish because they are small.

In hot weather, game fish may seek the deeper areas. Fishing at varied depths is one way to locate schools of fish. Many ponds have bullheads or catfish living at the bottom. These fish are relatively easy to catch on live bait fished down to where they live.

Lakes

Lakes are larger bodies of water and a popular place for sportfishing. Most anglers can find several lakes within easy driving distance that provide a variety of environments for fish.



Rock bass

Shallows. Most of the food and most of the cover, such as weeds and sunken trees, are found near shore. Thus, most fish at times will be found near the shallows, moving in and out to feed. Some species, such as panfishes and pike, tend to spend most of their time in shallow water. Others, such as the bass and walleye, move in and out at different times of day and under different conditions of weather and temperature.

Breakline. The breakline is where the shallow waters drop off toward the deep water. It is a place where many species of fish tend to congregate, waiting for the opportunity to feed.

Structure. Rocks, ledges, reefs, bars, and sunken obstructions, found in or near deep water, can be holding spots for schools of fish. These hangouts are used by various species between times when they move up to the breakline or into the shallows to feed.

Streams

Stream fishing for trout and salmon has a special attraction to anglers who learn to fish moving waters. The constant movement of a stream presents a natural challenge for an angler. Depending on the time of year, streams can be full of trout or salmon returning from saltwater to spawn. These fish draw anglers from miles around to try their luck.



Rapids. Where water rushes into a pool, crashing down over the boulders or thundering in from a waterfall, fish tend to gather. These are places where food collects and can easily be captured by the fish. Rushing water is highly aerated, which creates a cool, oxygen-filled environment. Some fish such as trout regularly live in such places, which are hatching sites for a variety of insects that trout prefer for food.

Cutaway Banks. Fish tend to hide where stream currents have carved holes under a bend in the shore, particularly where there are trees and exposed roots. Deep, quiet channels also are good spots to locate fish in streams.

Big Water

With an environment as big as the ocean, you can expect to find bigger fish. Deep-sea fishing for some of the world's largest species has become a popular sporting pastime.

Surf. Some spectacular angling is available on the edge of the nation's two oceans and along the coast of the Great Lakes. Long casts require specialized tackle.



Extreme care must be taken when waves get big, during tidal movements causing undertow, or when slippery rocks are present.

Surf fishing today is most often done with heavy-duty spinning tackle, although some saltwater casting is done with bait-casting outfits. Lures or baits require a long rod with plenty of backbone to get out beyond the shallows to where the fish lie. Surf rods are built with long handles for casting with two hands, using a sweeping motion, overhead and to the side.

Hundreds of lures are designed to take the variety of sport fish found in salt water. Various types of live bait and cut-up bait also can be bottom-fished for saltwater species. In the Great Lakes, surf angling is highly effective for salmon and trout. Chest-high waders or hip boots may be necessary to get into the edge of the surf.



Most saltwater anglers beach small fish and use a net to land the larger ones so the fish can be released alive. Great Lakes anglers most often use large landing nets, preferably with a companion handling the net while the angler concentrates on the fish.

Offshore. Trolling and still-fishing or drifting are the usual uses of boats in salt water, the Great Lakes, and the nation's big impoundments. Offshore saltwater trolling for swordfish, tuna, sailfish, shark, and other big species requires large fishing craft and heavy tackle. Most of this type of fishing is on charter boats with experienced guides.

A variety of saltwater fishing can be done with outboard craft and medium-weight tackle for anglers who may troll, cast, or bottom-fish. Party boats with experienced captains take large numbers of anglers to reefs where game fish are taken on baited hooks dropped over the side.

Great Lakes trollers have specialized equipment—planing boards and lead-weighted downriggers—designed to get lures out to the sides of the boats or deep down. Sometimes the boats are allowed to drift, with the anglers simply jiggling lures up and down or sending live bait to swim around below.

Where Fish Hide

Fish hide for two principal reasons: to conceal themselves from enemies and to ambush unwary prey swimming past. In the shallows, fish are found around weed beds, underneath overhanging trees and brush, near docks, and where rocks jut out from the shore. In deep water, fish are quite often found around clusters of big boulders where they conceal themselves in the shadows.

Factors Affecting Fish Behavior

Since before recorded history, fishermen have studied fish, trying to determine what conditions cause fish to bite more readily. There is a definite correlation between weather and fish action, usually with a spurt of feeding just before a weather front arrives. Fronts can be anticipated by a drop in atmospheric pressure, measured on a barometer. Normal barometric pressure is 30 at sea level. Low is below 30 and high is above 30. An approaching low, with the barometer declining, often indicates an approaching storm. Similarly, a rising barometer often indicates clearing weather.

Water temperature has a definite effect on fish. For instance, trout cannot endure water temperatures greater than 70 degrees. A sudden drop in temperature often will cause fish to stop biting. This is quite common after a storm passes. Rising temperature often causes fish to bite. In coastal areas, the tides have a strong influence on fish behavior.



Sunken trees that have fallen into the water are sure hangouts for almost all species of game fish.

Seasons

Spring usually finds the water cold but warming, with the best fishing on the warmer days. Spring is when many species are spawning, a time when they tend to strike lures quite readily.

More fish are caught in summer than in any other season. It is a time when more anglers are fishing and also when the water temperature is rising, speeding up the metabolism of fish and causing them to feed more.

Fall can provide some excellent fishing, particularly when there are warm days and cool nights. Cold fall days often are not productive.

Winter usually is associated with ice fishing. Water temperature under the ice is low but usually stable. Some species of fish—trout, pike, perch, walleye, and panfish—bite readily in winter.



Why Fish Bite

Fish react to various stimuli, not all of which have been determined. But when a bait or lure sets off the “trigger,” the fish strikes.

All species of fish have certain times of the day when they feed. Some of the periods seem to coincide with phases of the moon and tides, some with weather, some with time of day. Early morning and late evening are usually times when fish are active, but there are other times, even after dark.

In most instances fish bite because they are hungry. As an angler, you will imitate the kind of food you believe will attract a feeding fish. Your lure may imitate a minnow or a mayfly; your style of fishing may be with a spinning rod, casting reel and rod, or fly-fishing.

School fish, such as white bass, go on feeding frenzies, chasing swarms of bait fish and gulping down as many as they can. Then they stop abruptly and cruise along ignoring the same bait fish they were chasing a few moments before.

Fish can be “spooked” or turned off by the intrusion of a noisy boat or a noisy wader, by a badly presented bait or lure, by too big a hook, by a heavy line or leader that may be visible, or by a shadow falling on the water. There is an old saying: “If you can see the fish, they can see you.” And sometimes they just won’t bite, period.

With experience, the angler learns when and where each species is more apt to take a bait or lure.



Rainbow trout



Arctic grayline



Freshwater Fish

Lakes, ponds, rivers, and streams are home to many hard-fighting species. Fishing can be done from the shore, dock, while wading, or by watercraft such as a motorboat or canoe.

Walleye and Perch

Walleye and perch are among the finest game fish in North America. The walleye is particularly prized because it grows to a large size and is very tasty.

Many anglers troll for walleye, using minnowlike lures weighted down deep, jigs tipped with live bait, spinner-and-bait combinations, or just live bait with a slip sinker. Slowly trolling over sunken bars, alongside ledges and weed beds, and over sand flats (particularly those parallel to the breakline) can be effective.



Walleye

In early morning and evening, walleye may be taken by casting lures; excellent catches of walleye can sometimes be made late at night on slowly retrieved floating-diving lures. Numerous walleye are caught every year by still-fishing live bait either on the bottom or with a slip bobber.

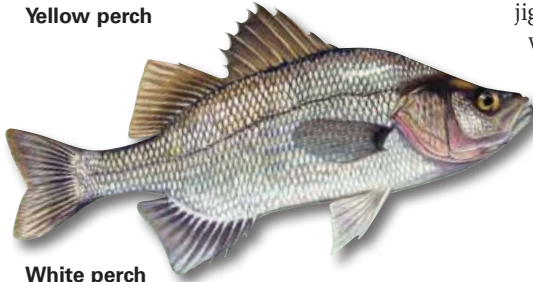

**Yellow perch****White perch**

Yellow perch are abundant and willing to bite almost anytime. These fish provide a lot of action when a school is located. The most popular method of perch fishing is with minnows, worms, or leeches on a small hook below a bobber. Tiny jigs, $\frac{1}{8}$ to $\frac{1}{16}$ ounce, with a piece of worm on the hook, often do the trick. In the spring, perch gather where streams enter lakes and where there are dams in rivers. They may be taken in large numbers with a streamer fly or a small spinner fished on a fly rod.

While perch will never take any trophies as fighters, they are fun to catch in large numbers and they make a tasty fish fry.

Largemouth Bass

No fish was more aptly named than the largemouth bass. Its jaw extends well back past its eye, and when it opens its mouth to swallow something, it seldom misses. Because of its ability to take a wide variety of lures and because it often strikes explosively on the surface, the largemouth is one of the most prized and highly sought game fish in North America. The first reels and casting rods made in the United States were tailored to bass fishing.

**Largemouth bass**

Largemouth can be caught on bait-casting, spin-casting, spinning, and fly tackle. They will hit floating lures, floating-diving lures, and bottom-bumping jigs. Weedless spoons and spinner baits that will not snag on vegetation when fished through the lily pads, often are productive. Pork rind lures, pork “eels,” and plastic worms also are effective. Largemouth also will hit bait of live minnows, frogs, leeches, and crayfish, which are life-forms that are naturally found in their habitat and are part of their accustomed diet.

In the South, largemouth grow to 20 pounds or more. In the North, 10 pounds is a record-breaker. Largemouth are structure fish, meaning they hang around brush, fallen trees, weed beds, and ledges, usually in fairly shallow water. Where they are heavily fished, they become cagey, and the angler must be careful, quiet, and skillful to be successful.

Smallmouth Bass

Averaging between 4 and 6 pounds, the smallmouth bass has been described as “pound for pound, the gamest fish that swims.” Many anglers will argue for other species, but there is no question that this snub-nosed, jut-jawed warrior of the cold water is a foe to test the tackle of any angler.



Smallmouth bass

The easiest way to distinguish the smallmouth from its largemouth cousin is by the upper jaw. In the smallmouth bass the jaw comes to a point just to the eye. In the largemouth, the upper jaw ends behind the eye. Also, smallmouth are yellow or tan with brown markings. The largemouth is a greenish-gray color with black markings. Both fish are known as black bass.



In areas where fishing pressure is heavy, many anglers release the bass they catch, perhaps keeping one or two small ones for supper. Small bass are excellent eating; big bass are not as good.

Smallmouth once were confined to the eastern United States but have been stocked over all of the northern states, much of Canada, and parts of the southern United States. Night crawlers, leeches, minnows, frogs, and hellgrammites (a type of aquatic insect larvae) are all natural food for this fish. It also will hit a wide variety of spinners, floating-diving lures, surface lures, flies, plastic worms and bugs, and jigs.

However, unlike the largemouth, which often will hit a fast-moving lure, the smallmouth likes its bait moving slowly, with frequent pauses and twitches. When it does strike, however, it strikes like lightning. The battle is spectacular, playing out as much above the surface as in the water. Its preferred hangouts are fallen trees, underwater cabbage beds, rock ledges, and deep boulder piles. In the spring the smallmouth is up in the shallows, but in the summer, it may be down 10 to 30 feet. In the late fall, the smallmouth schools at 40 feet.



Striped Bass

In salt water, striped bass range along the East Coast from Maine to North Carolina, and are a favorite of anglers who fish in the surf. Originally a saltwater species, several hundreds of these fish were trapped while spawning in the Santee River when the dam was built for South Carolina's Santee-Cooper hydroelectric project in 1938. Surprisingly, the stripers adapted to freshwater, spread over the reservoir, and grew rapidly, some to more than 40 pounds.

Since then, they have been successfully stocked in a number of reservoirs, creating a new inland game fish sport. Striped bass are strong fighters and usually are taken on light saltwater tackle. Most stripers are caught on live shad minnows, although casting heavy jigs and spoons can work well when the fish are feeding.

Anglers locate schools of stripers by watching the seagulls circling swarms of bait fish chased to the surface by feeding bass.

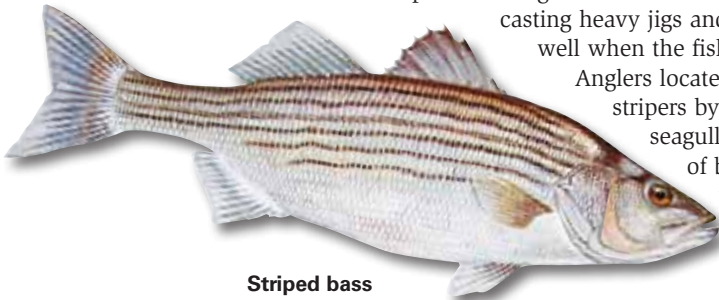

Striped bass

Panfish

This year, a million American young people will be introduced to the sport of fishing, and most of them will catch a species of panfish. Aptly named, the many species that make up this category are some of the tastiest in the frying pan. They also are fun to catch, and some are ferocious battlers, despite their relatively small size.

While panfish may be taken on almost any kind of pole, line, rod, and reel, catching these bantamweight warriors on a fly rod or ultralight spinning tackle is great sport. Panfish are highly susceptible to flies and tiny jigs. They also bite small panfish popping bugs, size 10 or 12, during the warm months when insects are hatching.

Rock Bass and Bluegill. The rock bass, a member of the sunfish family, is a brassy-colored fish with rows of black scales and distinctive red eyes. A stubby fighter growing to 2 pounds that will strike almost any kind of live bait or artificial lure, it likes to hang out around old bridge piers, docks, boulders, and weed beds. Except in the late fall when it goes deep, the rock bass is a shallow-water feeder that likes to take minnows and bugs near the surface.



Rock bass

The bluegill, like many of the sunfishes, has a shiny, dark blue patch on the edge of the gill cover. Also, like its sunfish cousins, it is brightly colored. The bluegill has purplish sides with black bands and a bright yellow or orange throat. It has a small mouth, and small hooks are required to catch it. Bluegill are found just about all over the United States and grow to 2 pounds, although 1-pounders are considered good catches. They are one of the toughest fighters among the sunfish clan.

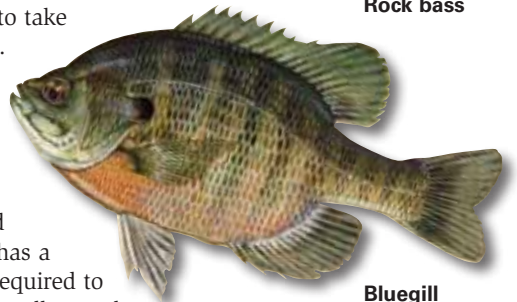

Bluegill

Crappie. Silver and black, the crappie grows to 4 pounds, although a 2-pounder is considered a trophy in most areas. It feeds mainly on small minnows and insects and will take small spinners and lures without hesitation. The crappie is often found close to structure. Be aware that the crappie has a paperlike mouth and must be carefully handled so that the hook does not pull loose. It is excellent eating.



Catfish

Smooth-skinned and scaleless, long, lean, and built for power, the catfish family is widespread in North America. Catfish are found in clear, icy waters of the North as well as the warm, muddy streams and bayous of the South.

They are highly tolerant of water temperature fluctuations and can withstand turbid water, even some pollution. They are relatively easy to catch, are fierce fighters, and make for fine eating when properly prepared. Be careful: All catfish have sharp spines in the pectoral and dorsal fins that can cause a painful wound to the unwary or careless angler.



Channel catfish are sleek and highly prized. They can grow to 30 pounds or more, but the average is 2 or 3 pounds. Flathead catfish and blue catfish regularly grow to more than 40 pounds, some reaching 100 pounds. The most common catfish is the much smaller bullhead—a dweller of small streams, ponds, and sloughs. Thousands of bullheads are caught each year by anglers with no more than a hook, line, and bait. Larger catfish are found below dams, in riffles, beneath undercut banks and logjams, and in deep holes and channels. The best way to catch them is to fish the bait on bottom.

Catfish Bait

Nearly any bait, alive or dead, will take a catfish. Channel cats, at times, will strike a lure as savagely as a walleye. Some favorite catfish baits are cut-up smelts or other small fish, worms bunched up on a hook, clam meat that has been allowed to mellow in the sun, and crayfish tails. Catfish also like liver, chicken entrails, and cheese. Commercial “stink baits,” which have a strong odor, also are good.

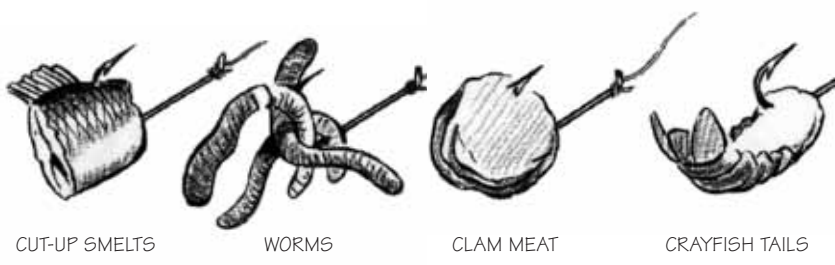

CUT-UP SMELTS

WORMS

CLAM MEAT

CRAYFISH TAILS

The Pike Family

Big, sharp-toothed, and mean-tempered, the fish that make up the pike family have a common trait: They strike first and ask questions later.



Pikes must be carefully handled to avoid contact with their teeth.



Northern pike



Muskellunge

Members of the pike family are excellent eating but are bony.

Northern Pike. Most common is the northern pike, found over a large part of North America. They may grow to 50 pounds. All of the pikes prefer large, flashy lures such as spinners, spoons, silvery floating-diving plugs, and noisy surface baits. They strike big minnows and will readily take strips of sucker meat or frozen smelts.

Muskellunge (Muskie). Biggest of the pike family, these fish grow to more than 60 pounds. The true muskie is light olive with brown spots. Hybrid muskies are light olive with brownish stripes. The hybrids are muskie–northern pike crosses. Muskies are not nearly as common as northern pike and are not as easy to catch, so they are much sought after as trophies.

Stream Trout

Trout are a cold-water fish, needing water of less than 70 degrees. For sheer beauty, the members of the trout family are hard to beat. They are sleek, without large scales, colorful, and designed to swim in moving stream waters.

Brook Trout (Char). A dark-green back with yellowish tracks, spotted sides with bright-red spots, red fins, and a white underside mark this all-American warrior. Brook trout are found anywhere from tiny beaver brooks to the great rivers of the North. In lakes it grows to 7 or 8 pounds, but the average brookie weighs less than a pound.



Brook trout

Rainbow Trout. Aptly named for the bright red streak down its silvery side and its bluish-green back, the rainbow trout is not only a handsome fish but also one of the most spectacular leapers among freshwater species.

There are many varieties of rainbow trout, some growing to more than 20 pounds.

The migratory steelhead, a fish that spawns in streams but spends most of its life in salt water or the Great Lakes, is a cousin.



Rainbow trout

Brown Trout. This European import has taken hold in many of the warmer streams that will not support native American species. It is stubbier than most trout, yellowish-tan with brown and red spots, shy, and sometimes difficult to catch. Planted in the Great Lakes, it can grow to more than 20 pounds.

All types of flies, small spoons, and spinners are effective for trout fishing. Where regulations permit, live bait for trout includes worms, minnows, and insects. Salmon eggs also can be good bait. When caught, trout should be either released or killed and kept in a creel (a special bag or basket), not in warm water where they will turn soft and deteriorate quickly.



Lake Trout and Salmon

While salmon always have been a popular sport fish in salt water and in the coastal rivers, new fisheries occurred in the Great Lakes when coho salmon were first stocked in Lake Michigan. There are now chinook and pink salmon to catch in this Great Lake, along with native lake trout.

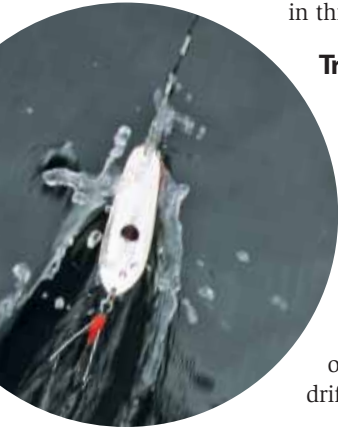

Trolling

This is the most popular method of taking both lake trout and salmon. Heavy-duty spinning tackle is most often used with lures pulled behind the boat near the surface or down deep, depending on where the fish are. Spoons and large, minnowlike lures in a variety of colors—from blaze orange to fluorescent green—are popular.

Downriggers, wire lines with heavy lead weights, are used to get the lures deep. Planing boards that float and run parallel to the boat often are effective in getting lures out to the side. Trout and salmon also may be taken by drifting while jigging heavy jigs below the boat.

Casting

Anglers without boats take large numbers of salmon and lake trout by casting offshore on points and at the mouths of rivers. In late summer, the salmon begin their fall spawning run. Lake trout follow a short time later. Long rods, 9 to 10 feet, are used with light saltwater reels to cast the lures far from shore.

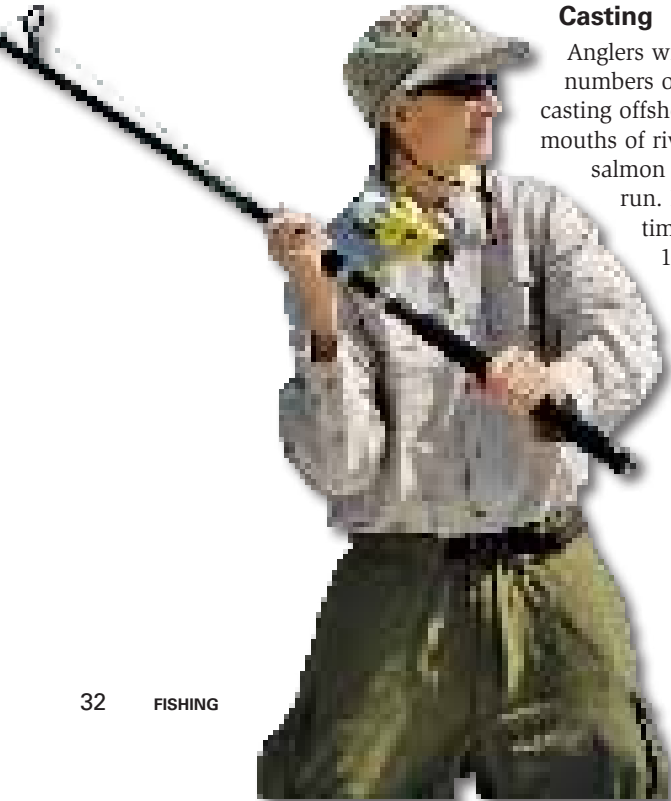

Ice Fishing

When winter comes and the lakes freeze over, a different type of fishing begins. Some species of fish—bluegill, crappie, perch, pike, walleye, and trout—may be caught readily through the ice.

The bulk of ice fishing is for species of panfish and is done with lures. The lures are bits of chromed metal, painted lead, or plastic designed to look like flickering minnows or struggling insect larvae in the water. They are used in conjunction with real insect larvae or tiny minnows and are jigged near the bottom.

Pike, walleye, and trout usually are taken on larger metal spoons, lures, and jigs baited with live or dead minnows. Most anglers use regular spin- or bait-casting reels on special, short ice rods. The drag is usually set on the light side so that a large fish can be played without the line snapping. Fish caught through the ice in the winter can be put in the bucket or box seat to take home. No fish, bait, or other trash should ever be left on the ice.



The standard outfit for an ice fisherman includes short rods; monofilament line; ice flies; spoons, lures, jigs, and bait; an ice **auger** to drill holes; a skimmer to dip the slush and ice chips out of the fishing hole; a bucket or box to sit on; and plenty of warm clothing.

Thin ice can be dangerous. Your merit badge counselor can tell you more about the hazards associated with ice fishing. Before you go ice fishing, check with local conservation officers for ice conditions if there is doubt about safety.





Saltwater Fish

The ocean coastline, including the estuaries of rivers flowing in, offers a variety of sportfishing from piers, wading the surf, casting from outboard skiffs, and trolling or bait fishing from big water cruisers. Some of the larger trophy fish, such as the tarpon, are wild acrobats and fun to catch but should be released because they are not particularly good to eat.

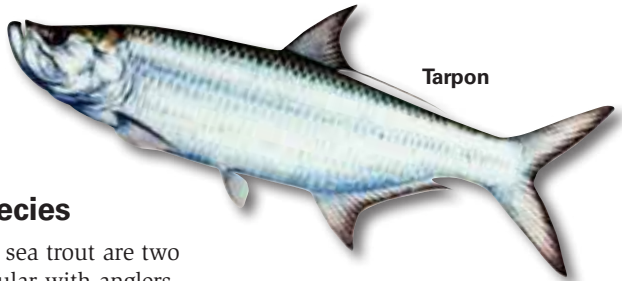

Tarpon

Shallow-Water Species

The pompano and spotted sea trout are two shallow-water species popular with anglers.

Pompano are among the tastiest saltwater fish. They also are frantic battlers and may be taken by casting or trolling small jigs, either plain or baited with sand bugs. Spotted sea trout (sometimes called weakfish) are abundant and easily caught where they swarm in coastal bays and lagoons and at river mouths. Using drifting or casting jigs baited with fresh shrimp is a surefire method. Trout also will hit spoons, surface lures, and fly rod streamer flies.

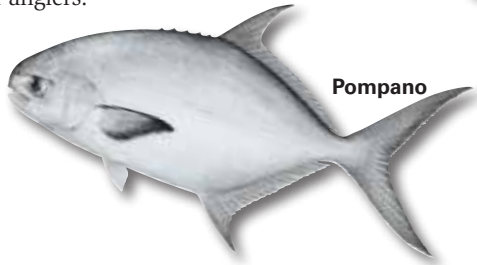

Pompano

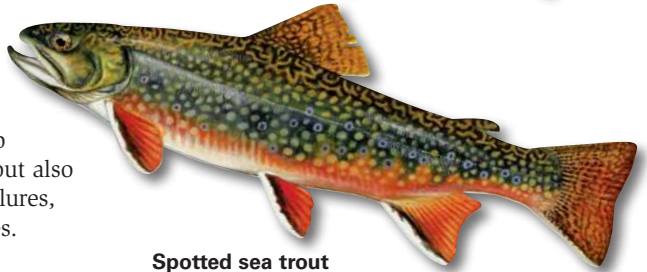

Spotted sea trout

California Yellowtail

This exciting fish, also called the amberjack, may grow to more than 60 pounds, but the average is 10 to 20 pounds. Live sardines, cast or trolled, are the most popular baits, although yellowtail sometimes will hit trolled lures. They are considered a fairly good table fish.

Snapper

A shallow-water fish that hangs around coral structures and often invades southern coastal streams, the mutton snapper runs from 5 to 20 pounds and is rated highly for food qualities. Good fighters on light tackle, they strike jigs, floating-diving plugs, and surface lures, along with shrimp and other live bait. They have sharp teeth, and most anglers use wire leaders for these fish. The red snapper, a deep-water cousin, lives farther north and usually is caught on still-fished cut bait. It is superb eating.



Catch and Release—With Care

Why catch and release a fish unharmed? There are many reasons, one of which is to prevent overfishing. Catch and release also helps lengthen the fishing season and with conservation of the fish. Here are tips on how to catch and release the right way.

- Use artificial lures with barbless single hooks. Fish tend to swallow live bait more deeply, and barbless hooks are easier to remove and do less damage than barbed hooks.
- Play the fish, then release it as gently and quickly as possible. Do not play the fish to exhaustion, or it may not recover.
- If the fish has swallowed the hook, cut off the line as close to the hook as possible. Never try to remove a deeply embedded hook because you may damage the fish beyond recovery or make it a more vulnerable prey.
- Avoid stainless steel hooks. If swallowed, they will not dissolve over time.
- Whenever possible, avoid removing the fish from the water. Prepare your camera for pictures first; hold up the fish for a quick photo, and release it immediately.
- If you must use a landing net, make sure it is made of soft nylon and not hard mesh, which can damage the slime that covers the fish and helps protect it from disease.
- If you must handle the fish, wet your hands first. Support the fish horizontally—never vertically—in the water across the back and head, avoiding the eyes and gills. Before releasing, revive the fish gently by moving it back and forth in the water until it swims away.



Balanced Tackle

When the rod, reel, and line are correctly matched to handle lure or bait of a given weight, they are considered to be in **balance**. When in proper balance, they allow the fisherman to deliver the lure or bait with accuracy within the desired distance. Modern tackle manufacturers are continually experimenting and upgrading their rods, reels, and lines to create more efficient tackle for easier casting.

Fly-fishing requires that the rod be equipped with proper line, the reel mainly having the function of line storage. Fly rods are usually marked with numbers indicating which line works best on that particular model.

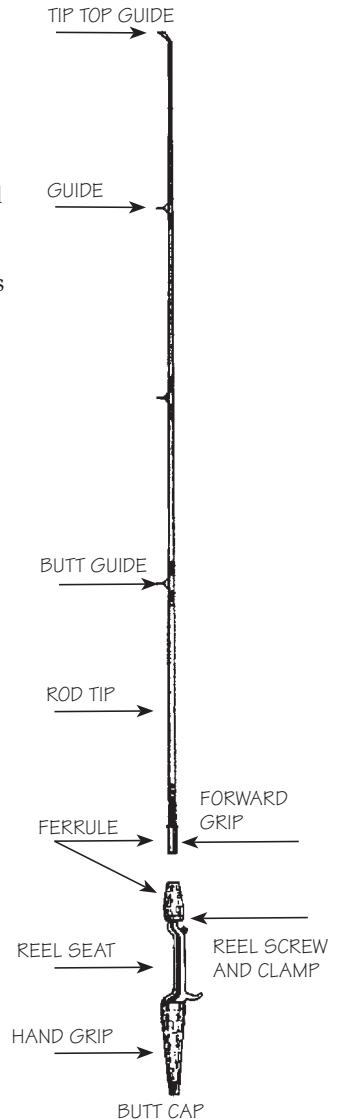
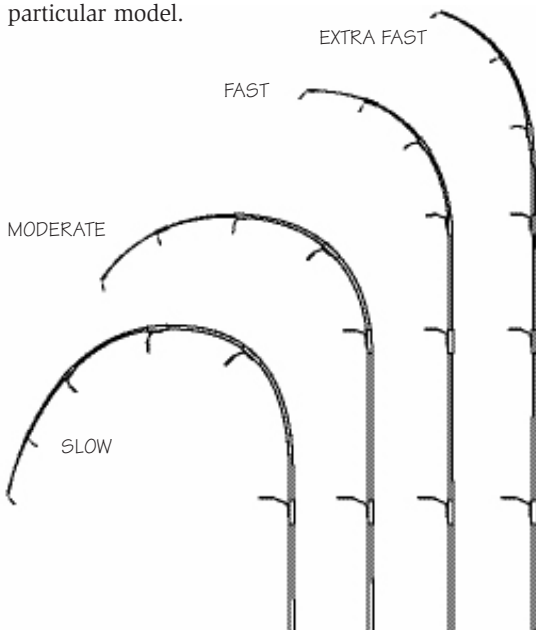

Equipment used in saltwater fishing is much the same as the equipment used in freshwater fishing except that every piece of tackle designed for saltwater fishing is more resistant to corrosion and is usually built on a larger scale: reels are huskier; rods can measure from 8 to 11 feet long; and lines and lures are heavier.

Tackle catalogs list rods and reels by weight and function, allowing the angler to make informed choices. Tackle dealers, tackle representatives at sport shows and demonstrations, and experienced anglers are all good sources of information on suitable tackle for the fishing of your choice.

The four general types of reels commonly used by fishermen are the bait-casting reel, closed-face spin-casting reel, open-face spinning reel, and, for fly-fishing, the fly reel.

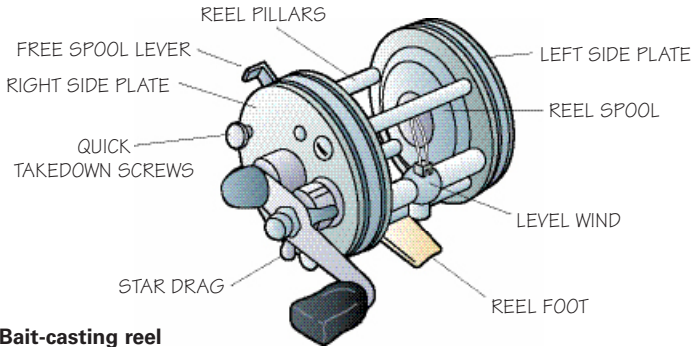

Bait-casting reel

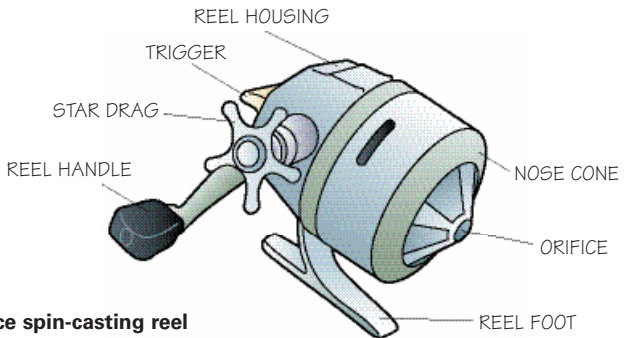

Closed-face spin-casting reel

Bait-Casting and Spin-Casting

Bait-casting and spin-casting are similar in that the lure is flipped from the tip of the rod, pulling the line from the reel. Casts of 60 and 70 feet are easily made. The lure is then cranked in by turning the reel's handle. The reel is on top of the rod and control of the cast is through use of the thumb on the casting hand.

However, bait-casting reels have a revolving line spool that must be “thumbed” lightly during the cast to prevent the line from overrunning and creating a backlash. Spin-casting reels have fixed spools mounted sideways. The line comes off the end of the spool. During the retrieve, a pin causes the line to wind back onto the spool. With a bait-casting reel, the line winds directly on the spool when the reel handle is turned.

All spin-casting and many bait-casting reels have adjustable drags that allow a hooked fish to take line out under preset pressure so that quick rushes will not break the line. These reels are extremely accurate and useful in hitting small openings in weed beds or around snags. However, learning how to master these skills takes practice.

Bait-casting is done with a wrist and forearm motion. The rod is held so that the reel handle is up, with the thumb holding the line secure. The rod is brought up sharply until vertical, the weight of the lure bringing the tip back to a one o'clock position. With an almost continual motion, the rod is whipped forward and the thumb releases the line, allowing the lure to shoot forward.

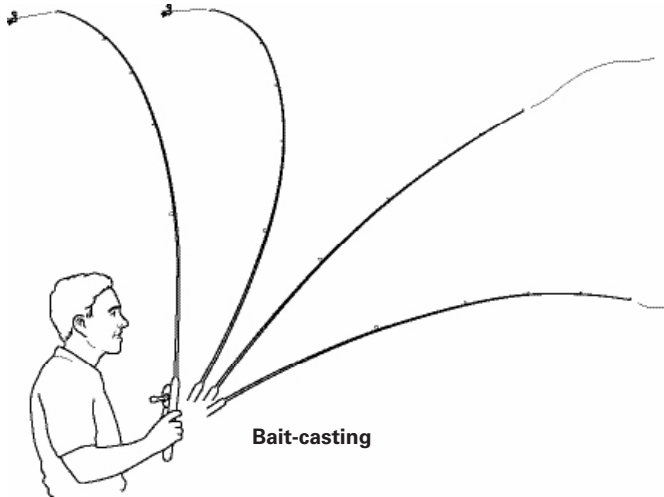

Before casting, always check behind you—you want to catch a fish, not another angler!

Spinning

Spinning outfits also may be used for trolling. The preset drag holds the line at a tension that will release on a strike from a heavy fish but will not release because of the motion of the boat or the pull of the current.

Although almost nonexistent in the United States before 1940, **spinning** has become a popular form of casting. The fixed-spool reel is mounted under the rod. The line is controlled with the index finger of the casting hand. The fingertip picks up the line as the free hand moves the spring-operated pickup arm to one side. The rod tip is raised to horizontal then swept forward, the index finger precisely releasing the line as the lure shoots out.

To stop the lure, the tip of the index finger touches the line and the free hand begins turning the reel handle forward, engaging the bail pickup automatically with the line. A roller on the bail lays the line back smoothly on the spool as the reel handle turns. A drag adjustment controls the tension necessary to pull line from the reel when fighting a fish.

Spinning tackle ranges from heavy-duty big-water outfits that require two hands to cast to ultralight combinations that weigh only a few ounces. Because there is no movable spool, long casts can be made effortlessly with spinning tackle. Tiny lures may be cast accurately on threadlike lines and large lures may be cast long distances on the heavier outfits.

Spinning

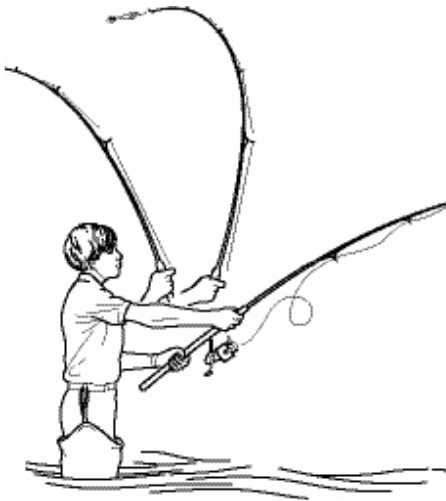

Open-face spinning reel

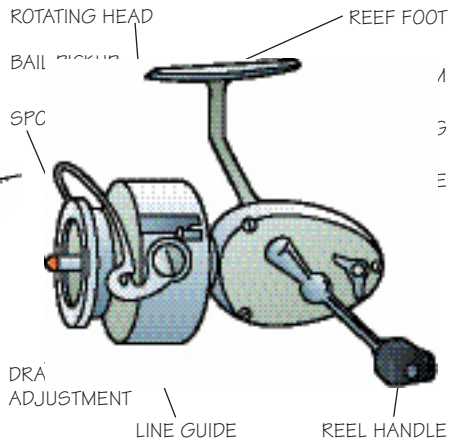

Fly-Fishing

When fly-fishing, the angler uses a long, flexible fly rod with which he casts a plastic-coated line. The weight of the line carries the fly out. The fly imitates the small insects (mayfly, caddis, stonefly, etc.) upon which fish regularly feed. **Fly-fishing** is a form of angling dating back hundreds of years to its origin in Europe. Early fishermen had limited resources and used a line tied to the tip of a long, thin rod. A system of guides, tied along the rod, was devised so that extra line could be released at the cast, allowing the bait or fly to sail out much farther. A reel was fastened to the lower, butt end of the rod as a place to store extra line.

For the cast, a minimum of 15 feet of line plus the leader is stripped out in front of the angler. The rod is brought upward sharply and the slack line gripped firmly and held in the free hand. The line and leader sail upward and above the angler in a loop. As the loop straightens out, the rod is brought quickly forward, the line and leader flying ahead in a forward loop. At the last moment, the forward movement is stopped, the line pauses briefly over the water, the leader straightens out, and the fly drops gently to the surface.



Many anglers tie their own flies for fly-fishing, like this Mickey Finn fly. You can learn more about fly-tying in the *Fly-Fishing merit badge pamphlet*.

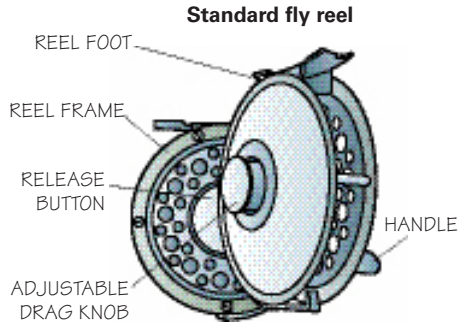

Fly rods are limber and light, weighing only a few ounces. The fly rod provides a maximum amount of leeway to a fighting fish. However, with skill, even large fish can be played and captured on lightweight fly tackle.

Fishing Lines

Varieties of lines of different weights, diameters, and construction are available today, made specially for different types of fishing—fly-fishing, spin-fishing, or bait-casting. Monofilament is a synthetic, single-strand line varying from 1-pound strength to lines that will easily hold 40 to 50 pounds. Lighter lines are more pliable and easier to cast with fine tackle. Monofilament is transparent and almost invisible to fish. It is used in spin-fishing. Braided lines are used in bait-casting. Fly-lines for fly-fishing are coated with a plastic finish to add weight. They come level or tapered to facilitate casting.



No matter what type of line you choose for your rig, keep it in good shape by following these tips.

- Store fishing line at room temperature. Too much heat or cold can weaken the line.
- If a knot forms in monofilament line near the lure, cut the line above the knot and discard the knotted piece.
- Frequently check the last 10 to 12 feet of casting line for nicks and abrasions by running the line between your fingers. If the line feels too rough, cut the rough piece, retie your rig, and resume fishing with fresh line.
- Dispose of used and broken line responsibly. Many tackle shops offer recycling bins specifically for used fishing line.

Knots for Fishing

Contrary to the thinking of many novice fishermen, a simple overhand knot will not do in most fishing situations. Although a knot may seem insignificant and hardly noticeable to the observer, it can be, and quite often is, the crucial factor between success and failure.

Improved Clinch Knot. This is the universal knot for tying monofilament to a hook or for tying hooks and swivels—any object having an eye—to the line. Because monofilament is slippery, it needs a knot that will jam against itself and hold tight, yet not cut itself. Run the end of the line through the eye, double the line back, and make five twists around the line through the eye, leaving a loop. Run the end of the line through the loop where the line joins the eye and then pass the line through the large loop. Partially close the knot and moisten it a little with water before securing it tightly against the hook eye.



Palomar Knot. This basic knot serves the same purpose as the improved clinch knot. Double the line to make a 3- to 4-inch loop, then pass the end of the loop through the eye. Hold the standing part between thumb and forefinger and tie a loose overhand knot in the double line with the other hand. Then pass the hook through the loop and pull on the doubled line to tighten the knot, guiding the loop over the top of the eyelet. Clip the tag end.

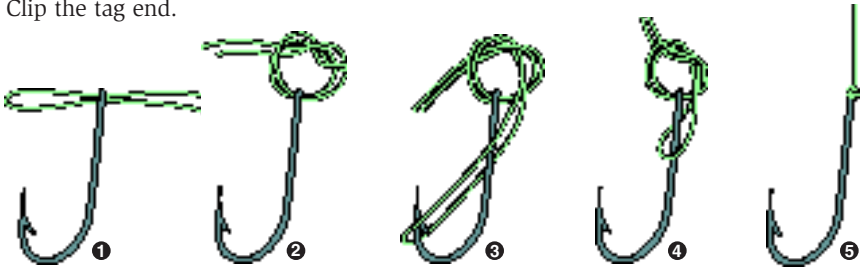

Wire Line or Wire Leader

To get lures down deep, such as when trolling for lake trout or saltwater species, anglers sometimes use braided wire lines. These are expensive and heavy, but they sink fast, keep the lure deep, and are nearly impossible to break.



Turtle (or Turtle) Knot. Popular with Atlantic salmon fishermen, the turtle knot makes a straight connection between the hook shank and leader. Since the knot is small and simple, it works well for tying a fine leader to a small hook, such as that of a fly.

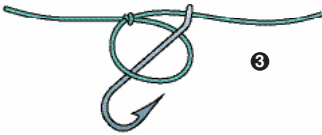

Begin by passing the end of the leader through the hook's eye from the front; then slide the hook up the leader so that it will be out of the way. Make a slipknot in the end of the leader by bringing the free end around twice, like a double overhand knot. Draw the knot tight and pass the loop over the hook. Pull the leader and manipulate the loop so that it tightens around the back of the hook's eye and not in the eye or on the leader itself.



Blood Loop or Barrel Knot. This knot is usually used to join two sections of line or leader, even if they are of slightly different diameters. Lap the ends of the lines or leaders several inches. Then twist one around the other, making at least five turns. Place the end between the strands and hold them together between thumb and forefinger. Wind the same number of turns (five) in the opposite direction, using the end of the other line. Then pull on the two ends to draw the turns closer together. When they have closed up snugly, pull tight on the ends to make the knot as small as possible. Clip the ends.

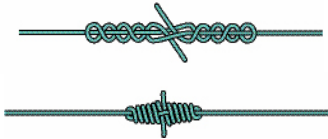

Double Surgeon's Loop. A double surgeon's loop is an easy way to form a loop in the end of a line or leader. Double the end of the line and make a single overhand knot. Then pass the loop around and through the overhand knot again. Hold the loop in one hand and the standing part and tag end in the other hand. Moisten the knot with water and pull to tighten. Clip off the tag end.

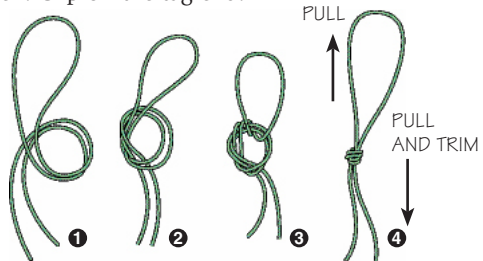

Loop Knot. This is used to tie on lures that require freedom of movement. The front knot is pulled tight, then the back knot, which leaves a loose loop in front of the lure, allowing the lure to swing back and forth, with a minimum of resistance.



Nail Knot. This is a good way of tying monofilament to lead-core line backing to a fly line, or a leader to a fly line. First, position the nail (or any similar object) along the lead core. Then lay a loop of monofilament on the nail. With the free end of monoline, take five or six turns over that loop and the nail and lead core. Next, run the end of the mono through the loop. Tighten the knot by pulling on both lines, slip the nail out, and tighten the knot all the way. Clip the protruding ends short.

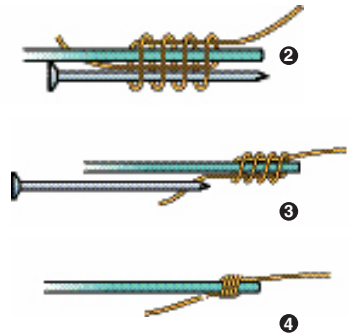

Wire Line to Mono Knot. Holding the wire line in your left hand, fold 4 inches of the end back over the standing part of the line. Run monofilament through the middle of the bend in the wire, passing it behind the wire and then over it. Make seven close turns around both lines. Pass the end of the monofilament over the center strand of monofilament and under the top strand of the wire, and then draw up snugly. Cutting the free end of the wire would leave a burr that could cut fingers. Instead, bend it back and forth. It will break close to the turns of the monofilament, leaving no burr.

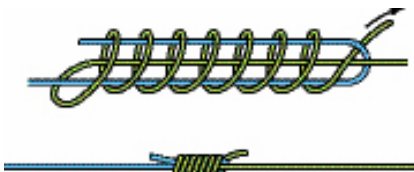

Arbor Knot. Locking the line on the reel spool takes a knot that will cinch up tight and not slip if a fish takes the line to the end. The knot at the terminal end is pulled tight first, then the other, and the loop snugged up against the spool.

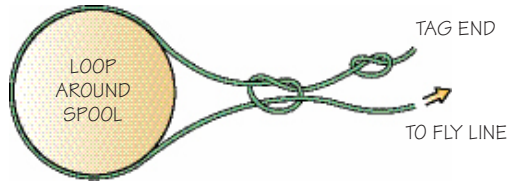

Tucked Sheet Bend. When fastening line to a leader loop or tying a snelled hook to the line, the tucked sheet bend is quick, tidy, and strong. It can be undone without cutting the line or leader.

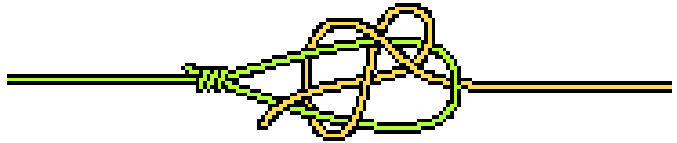

Snelling a Hook

This is a neat and simple way of attaching a hook to monofilament for certain types of bait fishing. To make a double-gang hook rig, leave the free line end long and tie in a second hook behind the first. This is a popular way of hooking worms for trolling or drifting.

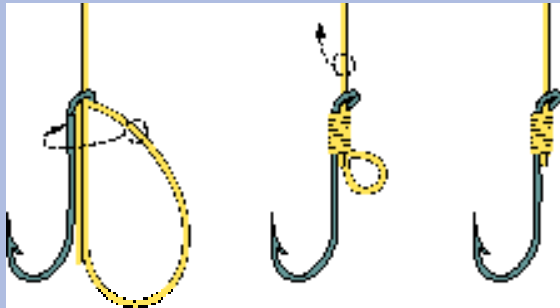

Hooks

Fishhooks are made of steel wire, bent by a machine to a desired shape, hardened by heat, and given a rust-resistant finish.

Hooks come in a wide range of sizes. Different hooks are designed for bait-fishing, lures, and flies. The hook you choose should be suitable for the fish you wish to catch. It can be confusing trying to figure out hook sizes, but one simple way is to start with size 1. The larger the number, the smaller the hook. Thus a size 2 is smaller than 1, and a size 4 is smaller than a size 2. Size 28 hooks are so small they are hard to see!

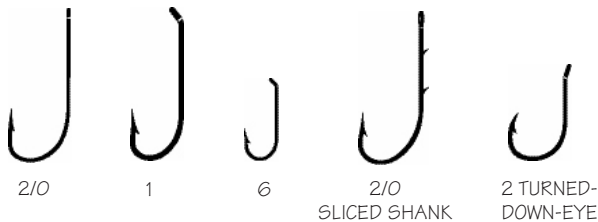

Going the other way, the addition of /0 means the bigger the number, the bigger the hook. A 1/0 is bigger than 1, a 2/0 is bigger than 1/0, and so on. A 12/0 hook is very large and is used to catch big fish such as tuna and shark.

Hooks also come in a variety of shapes. Straight-eye hooks are used most often with snaps and leaders. Turned-down-eye hooks are used for bait fishing and flies. Some hooks have sliced shanks to better grip live bait. Circle hooks are becoming increasingly popular because they are less damaging to a fish.

Some flies are tied on turned-up-eye hooks, providing more space between the hook point and the leader. Turned-up- or turned-down-eye hooks allow the leader to lie straight with the hook shank, making it easier to hook a fish. Anglers who practice catch and release use barbless hooks, which do less damage to the fish's mouth.

Jig hooks are made so that the wire will not twist inside the leadhead.

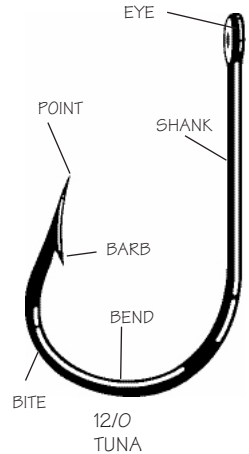
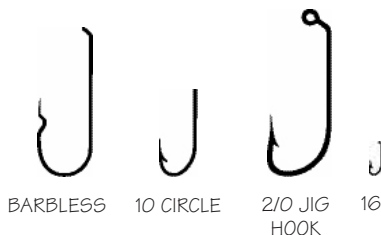

Hooks must be kept sharp to be effective. And care must taken that they get stuck only in fish, not in people.

Sinkers

Many types of **sinkers**, each designed for specific types of fishing, are useful in getting the bait down to the fish. Some of the more common sinkers include the following:

- Trolling sinkers, which move through the water effectively
- Split-shot sinkers, which come in a variety of sizes and are designed to be pinched on the line or leader
- Worm sinkers, which are effective in weed beds where plastic worms might snag or tear
- Dipsey and pyramid sinkers, which usually are used when a lot of weight is needed on the line
- Barrel sinkers—named for their shape—have a hole so the line can run free



Other types of sinkers include:

- Clinch-on sinker, which has two wings that can be bent over the line or leader and squeezed tight
- Saltwater sinker, popular with anglers who need a weight that will grip the bottom in tide and surf
- Heavy bank sinker, used for deep-sea fishing
- Sliding sinker, which has a hole in it so the line can slide through when a fish strikes, and which can slide over the bottom without snagging
- Keel sinker, which is used for trolling, because the keel keeps the weight from twisting the line

Despite the best intentions, anglers sometimes lose sinkers. Sinkers are often made of lead, and lead is toxic to wildlife. Scientists have discovered that lead sinkers have been responsible for the deaths of a number of loons and other water birds that accidentally ingested them. Wildlife experts are urging anglers to consider sinkers made of environmentally friendly materials such as rock, ceramics, iron, steel, and bismuth. Some states have instituted a lead-sinker exchange program in which anglers may exchange their lead sinkers for lead-free alternatives.

Swivels

Many lures and baits have a tendency to twist the line, causing it to kink and snarl. **Swivels** are designed to allow the baits to revolve, helping to eliminate the twisting. Many swivels are built with snaps, which allow a hook, lure, or leader to be clipped on without using a knot.

Using a three-way swivel allows a no-twist connection to the line, a no-twist connection with a leader to the hook or lure, and another no-twist connection to a separate leader and a sinker. Some species of saltwater fish are extremely powerful, requiring special steel swivel-snap combinations.

Swivels



BARREL



SNAP



THREE-WAY

Years ago, many fishermen made their own bobbers from corks, balsa wood, or porcupine quills.

Bobbers

While their technical name is “floats,” these markers bob on the water and so earned their popular nickname, **bobbers**. Bobbers also let anglers know when a fish bites; as a fish takes the bait, it causes the bobber to dip.

The simplest kind of bobber has a wire loop on the top and bottom that operates on a spring so that the line or leader can be clipped on and anchored in place. The depth of the hook is predetermined, and the bobber is set to hold the hook at that point.

Bobbers are made of plastic and are inexpensive. Besides the simple, round version, uniquely shaped bobbers can serve different purposes for the angler.

Pencil Bobber. Long, thin, and light, the pencil bobber is used for fish that bite lightly. The advantage of the pencil bobber is that a fish will feel no drag or resistance when it pulls on the bait. The line is held against the bobber by an adjustable rubber band.

Slip Bobber. The slip bobber has a hollow stem through which the line passes. A sliding knot is tied above the bobber on the line, and the knot will not go through the tiny hole in the stem. Any depth can be set. When the bait is reeled in, the bobber will slide down to the sinker, which makes it easy to cast.

Weighted Bobber. These transparent plastic bobbers are made so that they can be partially filled with water to give them casting weight. With the added weight it is possible to cast a light bait or even a fly a great distance on regular spinning tackle. The transparency allows the angler to see how much water is inside the bobber so that it doesn't lose all its flotation.

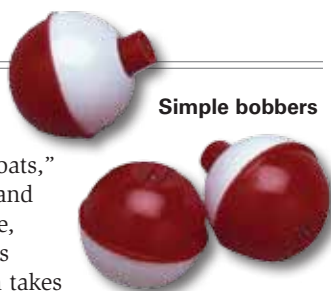

Simple bobbers



Weighted bobber



Slip bobber



Pencil bobber

Live Freshwater Bait

Natural foods are easy to fish, require a minimum of tackle, and are highly effective. Anglers may seek out their own bait or purchase it in specialized bait shops.

Be aware that releasing live bait and bait water can introduce undesirable fish, parasites, or diseases to native fish. To ensure that you do not accidentally make an unwanted biological introduction, try to obtain live baits that are native to the waters you intend to fish. At the end of the fishing day, do not release live bait (regardless of origin) into the water. Dispose of unused live bait and any water in the bait bucket on land well away from any water.

Before you make your live-bait choice, be sure to check the local fishing regulations regarding the use of live bait. Some classes of live bait may be permitted in your area only during certain times of the year or not at all.

Worms. Red worms, garden worms, and night crawlers all are good baits. A small hook (size 8 to 12) embedded in the head of a worm works well.



Minnows. Anglers use dozens of minnow varieties as bait. One common method is to hook the minnow through both lips, from the bottom up. Another is to put the hook through the body near the tail.



Crayfish. As crayfish grow, they shed their hard outer coat several times in the summer. When in the “soft” state they make an excellent game fish bait.



Leeches. The ribbon leech (*Nephelopsis obscura*) is an excellent bait. Most fish will reject bloodsucking leeches.



Hellgrammites. These larvae of the dobsonfly are found under rocks in riffles. They are excellent bait but must be kept off the bottom or they will snag the hook.



Live Saltwater Bait

All popular species of saltwater fish can be taken on live bait. Anglers who live near the coast often catch their own. Others purchase theirs in bait shops. It takes considerable knowledge of each fish species to know which bait to use and how.

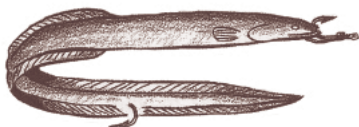

Eels. These are a common bait along the East Coast, particularly for striped bass and bluefish. Anglers often place eels on a double-hook rig, usually with a weighted hook in the head.



Crabs. Several species are used as bait, the fiddler crab being the most common. The larger claw is pulled off and the hook embedded in the crab at that point.

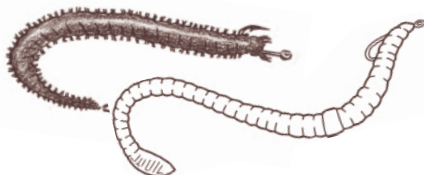

Sandworms. Along with bloodworms, sandworms are a popular bait. For large fish, the whole worm is hooked on. For smaller fish, the worm may be cut up and just a piece used.



Shrimp. Used whole or with just the tails on the hook, shrimp are excellent for a wide variety of fish. A piece of shrimp on a jig is highly effective.



Squid. Cut into strips, squid will take many species of saltwater fish. Other cut bait such as mullet or menhaden are used for weakfish, bluefish, channel bass, and striped bass.



Killifish. This popular bait for bottom species is fished live, hooked through the nose. Killies are tough and durable if given reasonable care.



Clams. These come in many sizes. Small clam meats are used whole; large ones may be cut up. Clam meats are obtained by pushing a knife between the shells and severing the muscles.

Artificial Lures

While some anglers prefer the natural attraction provided by live bait, others favor artificial lures that can be bought in sporting goods stores or made meticulously by hand.

Jigs. Hooks with lead weights molded into the head—called leadheads or jigs—are the basis for a whole range of popular artificial lures. The advantage is in having a single-hook lure that is compact but that can carry enough weight to be easily cast by a bait rod or spin rod. Jigs also are adaptable to a variety of styles that allow them to imitate food that fish recognize.



Among the several styles are plastic-bodied grubs impaled on a jig hook; bucktail hair tied to create a weighted streamer fly; weedless bucktail designed for fishing in brush; a “twister”-type plastic body that has a wiggling tail in the water; and a “Canadian” minnow-type jig made with a soft chenille body, feather hackle front and back, and a feather tail.

Tips for Using a Jig

- Jigs are meant for slow, patient fishermen. Retrieve them especially slow in cold weather or when ice fishing.
- Retrieve jigs with “action”—jerks or pulls imparting a swimming motion.
- When a fish strikes a jig, it may be detected as only a twitch in the line. Be aware, and set the hook immediately.
- Fish with the lightest jig that allows you to feel when the jig is on the bottom.
- Be sure to keep jig hooks sharp so they are not easily dislodged.

Plastic worms are fished slowly, on or near the bottom. With the Texas rig or weedless rig, the fish is allowed to mouth the bait before the hook is set.



Plastic Worms. Made of soft, pliable plastic, these artificial baits can be made to swim, wiggle, and dance underwater with an action fish cannot seem to resist. Four good ways to use plastic worms are worm-and-jig with an artificial night crawler trailing out behind a bare hook; a plastic worm impaled on the hook of a regular bucktail hair jig; a Texas rig, which uses a sliding sinker with the hook stuck through the head of the worm and the point buried back in the worm body; and a plastic worm on a weedless hook with a split shot clipped on the line for casting weight.



Spoons. When fishermen noticed that minnows and certain other aquatic creatures glistened in the sunlight, the idea of making lures out of shiny metal was born. Spoons are made by cutting pieces of metal to shape, hammering them out so that they wobble in the water, and polishing them to a high shine. Various colors of enamel are added to some; others are given gold or silver finishes. They are called spoons because most of them are shaped like the lower part of a teaspoon.

In trolling, fishermen use "cowbells," a large variation of the single spinner.

Spinners. A spinner is made by hammering a piece of metal very thin, drilling a hole in one end, and mounting it on a strip of wire. The metal blade spins around the wire shaft, glinting like a live minnow swimming in the sunlight. Spinners may be rigged with hair flies, feather streamers, or live bait. Sometimes they are used alone with the blade and hook. Most spinners work best if retrieved slowly, just fast enough for the blade to revolve without being a blur. Spinners are sometimes rigged with jigs for deep fishing. These might have snaps that can be clipped to the eye of the jig.



Plugs. The first plugs—minnowlike replicas—were carved out of wood. Some still are, but most are made of plastic by lure manufacturers. Floating-diving plugs rest on the surface until reeled in. They are designed to wiggle in the water like a minnow.

Some plugs are made to run deep. These may be either all metal or weighted with metal and plastic. Some have a long bill in the front that causes them to head for the bottom when reeled in. They also are effective lures when trolled behind a boat.

Surface plugs are made to imitate either a frog hopping across the top of the water or a large, injured minnow that is flopping around in distress. Bass, pike, and muskellunge are species most often caught on these gurgling, popping, and sputtering lures.

Floating-diving plug



Deep-running plug

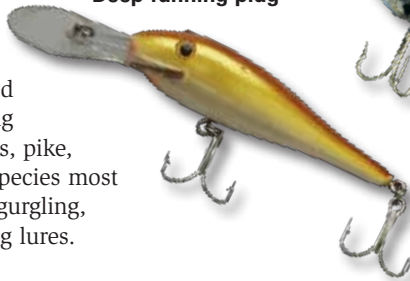

Surface plug



Most plugs have several treble hooks, and anglers must take care not to stick themselves or their fishing companions on the barbs.

Flashing Minnows

Fish often pursue schools of minnows up to the surface, causing the minnows to skip from the water in a desperate attempt to escape. These surface eruptions, called boils, show that there are game fish below on the feed. Casting minnowlike lures into these spots is often a surefire way of catching the game fish that are chasing the schools of minnows.

Flies. Flies are tied to represent insects, crabs, shrimp, mulberries, and tiny minnows—the preferred food of trout, salmon, and many other game fish such as bass, panfishes, carp, and pike. The fish are deceived into taking the imitation of their food. Some flies can also simulate hatching insects. Flies are made of hair, feathers, wool, chenille, and many other materials, all held together on the hook with thread and glue.

Dry flies are tied on light wire hooks and are constructed so that they will float like a newly hatched insect. Casting a dry fly so that it lands lightly and floats naturally requires skill.

Wet flies are tied so that they sink and are fished beneath the surface. They are meant to imitate the many insects that swim in the current before they get airborne. Trout and other species feed on these in great numbers.

Longer hooks, wisps of hair, and soft feathers make the long, slim **streamer flies** appear like shiners, chubs, darters, and other minnows. Sometimes they can be sunk with a split shot to get into the deep holes where big trout lie. Most streamers are fished rapidly in swift jerks to imitate frightened minnows racing for freedom.

Larvae that will later hatch into winged insects crawl in the mud and gravel on stream and lake bottoms. **Nymphs** are tied to represent these different types of larvae. Nymphs ride to the surface to hatch as mature insects.

Both largemouth bass and smallmouth bass are ever on the alert for big bugs, frogs, mice, or anything else edible that might fall into the water. **Bass bugs** are tied with cork or hair bodies so that they will float easily. Some have concave heads that make a noisy “pop” when jerked on the surface with a fly rod.

Sick or injured minnows often struggle on the surface. Bass spot these **cork minnows** as an easy meal and are quick to gulp them down.



Tied of hollow deer hair, the **hair mouse** lure looks like a little mouse that stumbled and fell into the water—all a bass needs for a quick lunch.

Usually tied with hairy legs and painted with green spots, these high-floating **cork-bodied frogs** appear to the fish just like the real thing.

Cork bugs can be made more lifelike by adding strands of **rubber legs** that stick out of the sides and wiggle to mimic swimming. Small cork-bodied lures, called **panfish bugs**, are sometimes the best baits for bluegills, rock bass, and crappies, particularly in the spring when these fish are in the shallows.



Rigs

When bait is used with any combination of bobbers, line, sinkers, and hooks, a fisherman's **rig** is created. The rig usually is connected to or fashioned from the end of the fishing line.

Freshwater Live Bait Rigs

There are many combinations of freshwater rigs, and each one has a special function.



Slip Sinker. Designed to get the bait down to the bottom while also allowing the fish to run free without any drag on the line, the slip sinker has a hole through which the line can run freely. A swivel and snap below the sinker keep the sinker from sliding down to the hook.

Jig-and-Bait. This is an old standby with most freshwater anglers. The leadheaded jig gets the bait down to the fish where it can be drifted or retrieved in short jerks. Minnows, worms, leeches—all live bait—work well with this method. When a fish strikes, it must be allowed to run with the bait before the hook is set.





Slip Jogger. With the slip jogger rig, the hollow stem on the slip bobber allows the line to slide through to a preset depth. But when the bait is reeled in, the bobber slides down to the sinker. Thus the angler can cast the bait some distance away, yet the bait and sinker will drop to the proper depth. A wisp of heavier monofilament tied to the line makes a knot that stops at the bobber top.

Floating Jig Head. Instead of a leadhead, the floating jig head is made of balsa wood or hollow plastic. This rig, with live bait, is used with a slip sinker and is designed to get down to the bottom but will keep the bait and hook 18 to 24 inches off the rocks. It is an effective and relatively snag-free method of fishing all varieties of live bait.

Saltwater Bait Rigs

Surf anglers generally use two basic rigs when fishing with natural baits. The first, the standard surf rig, uses a three-way swivel tied a few inches above a pyramid sinker. The hook and leader are tied to one eye on the three-way swivel, and the line is attached to the remaining eye.

The other rig is known as the fish-finder rig. The fish-finder has a ring on one end and a snap on the other. A large-sized snap swivel may be used as a substitute. A barrel swivel is inserted between the leader and the line to act as a stop.

Both rigs can be used with different leaders and various sizes and types of hooks, depending on the fish you are after. Nylon monofilament, wire, or stainless-steel wire measuring about 18 inches long is recommended. Either rig can be used for striped bass, channel bass, blues, weakfish, and other surf-feeding fish.

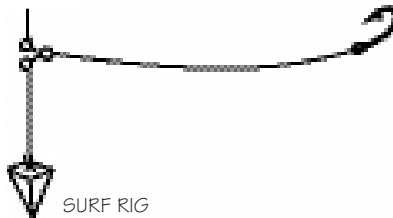

SURF RIG

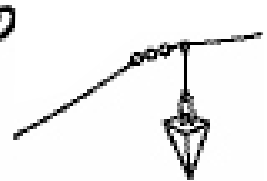

FISH-FINDER RIG

You can attach a cork to a surf rig or a fish-finder rig to float the bait off the bottom and help keep it away from crabs and bottom snags.



Pacific Salmon Rig. This is an ideal rig for slow trolling or drifting when fishing for king and coho salmon. A plug-cut or a whole herring is attached to a two-hook rig on a 3-foot leader. The leader is attached to the eye of a crescent sinker weighing from 2 to 6 ounces, depending on the current and the depth you want to fish. Let the rig go down to the bottom, and then reel back slowly. When you get your first strike, mark your line so that you can let the rig down to the same depth again.

Summer Flounder Rig. To rig for fluke, attach 2 or 3 feet of leader to one eye of a three-way swivel. Attach a sinker to another eye with only an inch or two of leader line. Then, attach a long-shanked hook to the end of the leader. Use a strip of squid or clam for bait. To further enhance the rig and draw the attention of more fish, add a spinner blade or two to the leader.

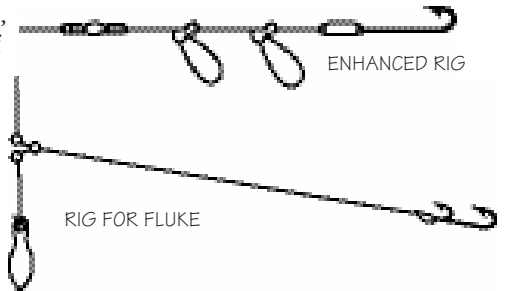

Winter Flounder Rig. This two-hooked rig uses a wire spreader to keep the two hooks apart so that they can lie together on the bottom where the flounder will be feeding. The sinker is attached to a snap in the middle. The single-hooked rig has its hook tied a few inches above the sinker. Both rigs use a long-shanked hook.

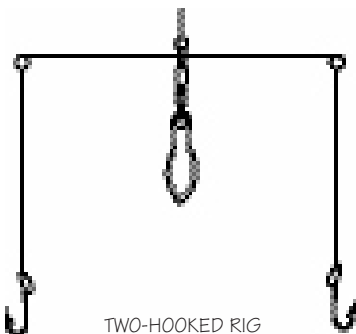

TWO-HOOKED RIG

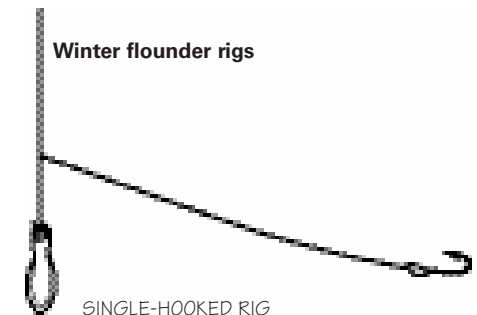

Winter flounder rigs

SINGLE-HOOKED RIG

Inexpensive tackle carriers can be adapted from plastic boxes that are sold in hardware stores to hold bolts, nuts, and other small items.

Fishing Gear and Craft

Before you head out to fish a lake or stream, you'll need to pack a **tackle box**, a landing net, and other necessary gear. To ensure an enjoyable day of fishing, be sure you dress for the weather conditions.

Tackle Boxes

Carrying cases for lines, leaders, hooks, lures, reels, and other pieces of equipment come in a wide range of sizes. New, rugged, noncorrosive plastic tackle boxes have largely replaced the old metal boxes used years ago. All tackle boxes are designed to keep the items separated so that they do not become tangled. Some anglers keep all their tackle in a large box, using smaller boxes to carry whatever they will need for one day. Some have separate boxes for spinning, spin-casting, bait-casting, saltwater, and fly-fishing equipment. A well-ordered tackle box makes fishing easier and is the mark of an experienced angler.

Many fly fishermen prefer plastic or aluminum boxes to hold individual flies. All the flies needed for one trip can easily be carried in a small box that fits in a jacket pocket.



Over the years many items worth a lot of money may accumulate in a tackle box, some of them difficult to replace. Smart anglers are careful not to drop their tackle box into the lake or stream nor to leave it on the shore unattended and vulnerable to theft.

Tackle Box Items

Among the usual lures, line, and other necessities, consider storing a few of the following items with your tackle.

- A pair of gloves
- Sunglasses
- A disposable camera
- A first-aid kit
- Hand towels
- Insect repellent
- Sunscreen
- A compass
- A boot repair kit



Landing Nets

Landing nets come in a variety of sizes from small, light, trout nets that hang from a cord around the body to huge boat nets.

The type of fishing an angler will be doing determines the type of net to be used. You can land some fish by hand, but using a landing net ensures that the fish will not slip and get loose. If the fish is to be released unharmed, it is better to reach down with the fingers or with pliers and slip the hook loose while the fish is in the water.

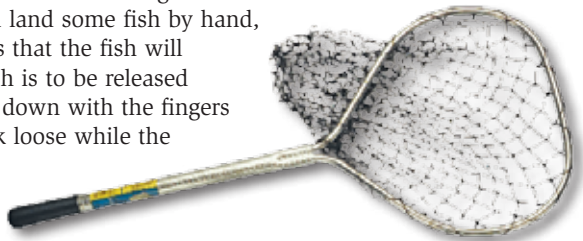

Stringers

In cool weather when the water is cold, some species of fish may be kept alive on a stringer until the day is over.

Stringers with individual snaps are best, keeping the fish separated and allowing them more breathing room.



Creels

Trout deteriorate rapidly when left in the water on a stringer. Creels are willow baskets made to hold trout that have been gilled and gutted. Damp moss or grass in the bottom of the creel will keep the trout cool.



Accessories

Fillet Knife. A good, sharp knife with a long, thin, flexible blade is essential for cleaning fish. It should be kept secure in a sheath when not being used.

Sharpener. A sharpening system capable of honing a razor's edge should be available at home. For fishing trips, a small steel or diamond-edge sharpener will touch up the blade when work needs to be done. Such a sharpener also can be used to touch up hook points that get dull.

Line Clipper. Anglers always should use some type of cutter or knife to cut monofilament line, never the teeth. A fingernail clipper on an elastic cord is a handy item.

Long-Nosed Pliers. Use these pliers for taking hooks out of fish and for straightening bent hooks. Pliers should be equipped with side edges for cutting hooks.

Reel Oil. A can of oil and a small tube of gear grease will keep reels running smoothly and make them last years longer.



Clothing

Since fishing is an outdoor pastime, wear clothing suitable for the season that will protect you from the elements.



Rain Gear. Fishermen discover quickly that rain often accompanies some of the best fishing. The best outfits are matching rain parkas and pants in earth tones, made of waterproof and windproof fabric. Lightweight rain gear can be rolled into a small package and stowed in the pocket of a jacket or pack. Ponchos will do a good job of shedding rain, but they provide poor coverage on windy days and make casting difficult.



Fishing Vest. This handy many-pocket garment is useful for carrying hooks, leaders, flies, lures, bait, and other items. The fishing vest helps keep an angler's hands free. While it is not a necessity, it is convenient for the angler who can afford one. When shopping for a fishing vest, think about the weather conditions you will encounter. Be aware of the bulk your filled pockets may create. You might want to consider a vest that comes with a personal flotation device built in—it will inflate if you pull a cord.



Footgear. Sneakers or leather boots are suitable footwear for boat fishermen, but the wading angler needs to pay careful attention to the feet. In cold weather, or in icy trout streams or surf, hip boots—or better yet, chest-high waders—help keep the legs dry. In warm streams during summer, it may be tempting to wade barefoot, but wading with bare feet invites injuries from broken glass, rusty nails, or even a spiny sea urchin. To avoid foot and leg injuries, wear a pair of old shoes and old jeans.

Fishing Craft

Almost any kind of watercraft can be used for fishing. Some boats lend themselves more readily to angling than others, and some boats are designed specifically for fishing.

During any Scouting activity afloat, your group must abide by the BSA's Safety Afloat procedures. Remember to always wear a personal flotation device whenever you are afloat. Your Scout leader can review the Safety Afloat guidelines with you.



Bass Boats

These craft are unique to a special kind of angling. The seats are high to make casting easier. They have a large motor to get from one spot to another, and a smaller electric motor that may be used to guide the boat stealthily along the shoreline.

Canoes and Kayaks

These are at the other end of the watercraft spectrum—light, portable, low in price, and nonmotorized. They are excellent fishing craft, because they make it possible to stalk silently and to maneuver quickly when a trophy fish is hooked. Remember, however, that it is unsafe to stand and cast in canoes and kayaks.

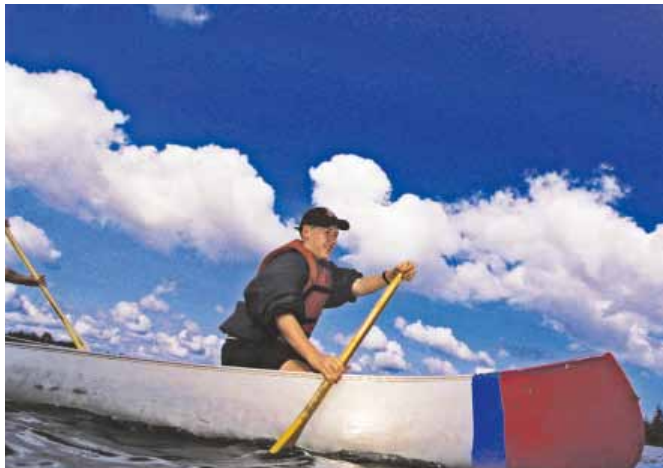

Canoes and kayaks are handy for getting into those hard-to-reach rivers and lakes that seldom see many anglers.

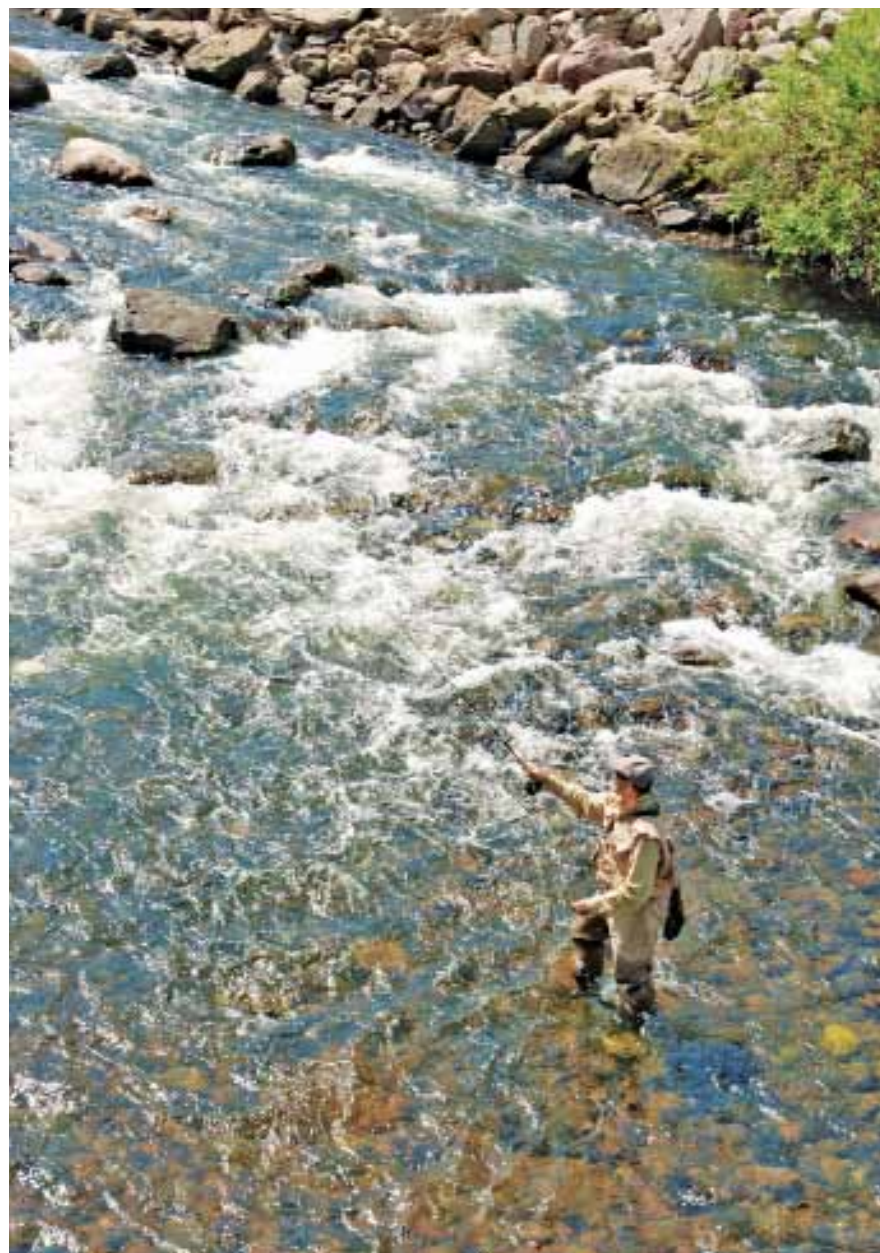

Safety Practices

When fishing, you might add to the Boy Scout motto, “Be Prepared,” the advice “Be Careful.”

Trip Itinerary

Always fish with at least one other person and always tell your parents or guardians where you are going and when you expect to return. If fishing in a remote area, leave your trip plan with a resort owner or dock operator. If nothing else, leave your written itinerary under the windshield wiper of your car. If you run into trouble, trained searchers will know where to look for you.

Wading

Wading can be treacherous, particularly in the spring when water is high or late in the fall when water is cold. It is best to start wading in shallow water before venturing farther out. This will help you gauge water current and depth. It will also help if you wade diagonally rather than launching into the current straight on.

Rock-bottom streams often are slippery. Experienced anglers take small steps and wade slowly, moving one foot ahead and feeling the bottom while supporting the body weight on the other foot. Steel cleats or felt boot soles sometimes help, as will walking around slippery rocks rather than over them whenever possible.

A wading staff, tied to a wading belt with a thong, can be a handy aid in fast water. (A wading belt helps keep water from flooding your waders.) If you lose your footing, you may want to float downstream to help you regain your footing and balance until reaching slower water.

If the water is too high or too fast, go fishing elsewhere. Try a lake or a pond.

Avoid alcohol at the waterfront. Despite the fact that it is illegal for anyone under 21 to drink alcoholic beverages, alcohol is a factor in half of all drownings among teenagers and adults. The death rate is especially high among young men ages 15 to 24.

Boating

Weather is a chief concern when on the water. It pays to check the forecast before venturing offshore and to keep an eye out for gathering clouds, the signal to get back to shore—fast. A responsible angler should learn the water and carry an accurate depth map or chart, compass, and other safety gear.

A serviceable boat repair kit is essential for emergencies. Check running lights to make sure they operate properly. Learn the boating laws of your state and those of the U.S. Coast Guard. Know before you go!



Always be aware of the tides changing and of rapidly rising water.

Canoe Travel

The canoe is a superb craft for fishing but has special requirements for use. When fishing in heavy waves or in fast currents, it usually is best for the bow angler to do the casting and for the stern paddler to keep the craft under control. It may be desirable to have an anchor made out of a mesh bag filled with rocks. In streams, anglers sometimes use a canoe pole, fitted with pointed steel “shoes” on the bottom. The pole allows the craft to be moved upstream easily and also can be used to snub up against rocks going downstream to hold the canoe in place when fishing a particular spot.

Sometimes it is advisable not to land an especially big fish in the canoe. Instead, take it to the shore and beach it. Once the bow is eased up on a sand or gravel bar, you can get out in the shallow water where the fish gradually can be brought in close enough to net. Be careful when landing any fish, because spiny fins, sharp teeth, and sharp gill covers (such those on the walleye) can inflict nasty cuts that may get infected. Any such cut should be cleaned and covered with an adhesive strip.

Wise canoe anglers keep all extra gear lashed to the thwarts in case of a spill. Inflatable camera bags and floatable containers for tackle may help prevent an expensive loss. A good flashlight or lantern will help you find directions in the dark and is essential for signaling oncoming motorboats.

In any watercraft, either canoe or boat, you should always wear a U.S. Coast Guard–approved personal flotation device (PFD). Newer PFDs are less bulky than they used to be and do not interfere with casting. There are fishing vests with inflatable pouches that do not look like life jackets but serve the purpose.

Near-Drowning

Drowning is the third leading cause of accidental death in the United States. You can prevent a near-drowning situation by following a few important safety practices.

Should your boat capsize, stay with the boat. It will be easier for rescuers to spot something the size of a boat than a person treading water. In addition, you might be able to climb onto the boat to await rescue.

Whenever you are afloat or in the water, remember to practice the buddy system. Doing so will make your outdoor adventure safer and more fun.



Be sure you follow the BSA's Safe Swim Defense plan on all Scout outings that include water activities (your adult leader can review this with you). See the *Swimming* merit badge pamphlet for more information about safe swimming skills. Information on how to respond to a near-drowning victim can be found in the *First Aid* and *Lifesaving* merit badge pamphlets.

It's always a good idea to carry an extra paddle in case one breaks or is lost.



Monitor a hypothermia victim closely for any change in condition. Do not rewarm the person too quickly (for instance, by immersing the person in warm water); doing so can be dangerous to the heart.

First Aid and Fishing

Typical first-aid concerns while fishing are covered here. For more detailed information, see the *First Aid* merit badge pamphlet and the *Boy Scout Handbook*.

Hypothermia

Hypothermia is the lowered internal body temperature that occurs when the body loses heat faster than it can produce it. Water or air temperatures lower than 70 degrees pose hypothermia risks, and rain, moving water, wind, and wet clothing substantially increase the loss of body heat. Any combination of cool weather and damp clothing, wind, exhaustion, or hunger can lead to hypothermia. In fact, most cases of hypothermia occur when the air temperature is well above freezing.

The best way to deal with hypothermia is prevention. Dress appropriately for the weather; always carry rain gear to keep yourself and your clothing dry. Wear a hat and proper footwear, eat plenty of energy-boosting foods, drink an adequate amount of fluids (hypothermia increases the risk of dehydration), and do not push yourself to a dangerous point of fatigue. See the *Swimming* and *First Aid* merit badge pamphlets for more information.

Dehydration

When we lose more water than we take in, we become dehydrated. Symptoms of mild dehydration include increased thirst, dry lips, and dark yellow urine. Symptoms of moderate to severe dehydration include severe thirst, dry mouth with little saliva, dry skin, weakness, dizziness, confusion, nausea, cramping, loss of appetite, decreased sweating (even with exertion), decreased urine production, and dark brown urine. For mild dehydration, drink a quart or two of water or sports drink over two to four hours. Rest for 24 hours and continue drinking fluids. See a physician for moderate to severe dehydration, which requires emergency care; the victim will need intravenous fluids.

Heat Reactions

Protect yourself against heat reactions such as heat exhaustion and heatstroke by staying well-hydrated. Drink plenty of water; don't wait until you are thirsty to drink or it may be too late.



Sunburn

Sunburn is a common injury among people who enjoy being outdoors. Most sunburns are first-degree burns, but prolonged exposure to the sun can cause blistering—a second-degree burn.

If you or one of your companions gets sunburned, prevent further injury by getting the person out of the sun and into the shade. If no shade is available, have the person put on a brimmed hat, pants, and a long-sleeved shirt that will afford protection from the sun. Treat painful sunburn with damp cloths. Remedies containing aloe vera might also provide relief.

Sunburn is easy to prevent by applying plenty of sunscreen with a sun protection factor (SPF) rating of at least 15. Reapply if you are sweating and after you have been in water. A broad-brimmed hat, long-sleeved shirt, and long pants provide even more protection.



In hot weather, watch for signs of heat exhaustion (pale, clammy skin; nausea and fatigue; dizziness and fainting; headache, muscle cramps, weakness) and heatstroke (very hot, red skin that can be either dry or damp with sweat; rapid and quick pulse, noisy breathing; confusion and irritability; unwillingness to accept treatment; unconsciousness). If you or someone in your group shows signs of a heat reaction, get to a cool, shady place. Have the person lie down with the feet, head, and shoulders slightly raised, and remove excess clothing. Cool the victim any way you can (cover the person with cool, wet towels, or sponge the person with cool water; fan the person; place the victim in a stream). Keep a close watch over the victim. If you do not see a rapid recovery, seek medical attention right away.

Minor Injuries

It is a good rule of thumb to keep a first-aid kit with your fishing gear. Use it to treat minor injuries such as cuts, scrapes, and insect bites. For injuries in which the skin is broken, wash the area with soap and water or clean it with antiseptic to help prevent infection. Severe wounds need immediate medical attention.

Consult the *Boy Scout Handbook* for advice on what to include in a first-aid kit.



Many spider bites can be dangerous. Victims of spider bites should be treated by a doctor as soon as possible.

The bites or stings of insects, spiders, chiggers, and ticks can be itchy and painful. Some can cause infection. Applying calamine lotion may bring relief, but the most important thing to remember is to try not to scratch. Applying an ice pack to these injuries can help reduce swelling.

For a bee or wasp sting, scrape away the stinger with the edge of a knife blade. Do not try to squeeze it out. That will force more venom into the skin from the sac attached to the stinger. Ice also will help ease the swelling of stings.

If a tick has attached itself, grasp it with tweezers close to the skin and gently pull until it comes loose. Do not squeeze, twist, or jerk the tick, as that could leave its mouthparts in the skin. Wash the wound with soap and water and apply antiseptic. After dealing with a tick, thoroughly wash your hands and any affected area to help prevent Lyme disease, a bacterial infection that is spread through contact with infected ticks. If redness develops in the bite area, see a doctor.



Puncture Wounds

Puncture wounds can be caused by pins, splinters, nails, or bits of broken glass. The sharp spines in the pectoral and dorsal fins of catfish and some other species also can cause puncture wounds. All can be dangerous, because they allow germs into a wound that is hard to clean.

To treat a puncture wound, encourage the wound to bleed to help flush out dirt or other particles that might have been forced inside. Use tweezers sterilized over a flame or in boiling water to pull out the object that caused the wound. Clean the injury thoroughly with soap and water and rinse well with clear water. Allow the wound to air dry, and cover it with a clean, dry dressing. Tetanus is a very real danger with puncture wounds, so be sure to see a physician about the possible need for a tetanus booster shot.

Fishhooks also can cause a nasty puncture wound. Always be aware of the path of your fishing rod and line when you cast to prevent the hook from catching on anything—especially another angler! If a fishhook wound does occur, never try to remove a hook that is lodged in the face or near an eye, artery, or other sensitive area.

If only the point of the hook enters the skin and does not go deep enough to let the barb take hold, you can safely remove the hook by backing it out. If the barb becomes embedded, it's best to let a physician remove it. If medical help is not available, try this method:

1. Tie a length of strong string to the bend of the hook.
2. Press down on the shank of the hook to free the barb.
3. While maintaining pressure on the shank, pull firmly on the string in the direction in which the hook entered.

If the hook has lodged so that the barb is visible above the skin, try this method:

1. Cut off the barbed end with wire cutters or pliers.
2. Back the shank of the hook out through the entry wound.

After removing the hook, wash the area with soap and water and cover it with a dry adhesive or gauze bandage. Be sure that the injured person consults a physician.

Back out hook if barb has not taken hold.

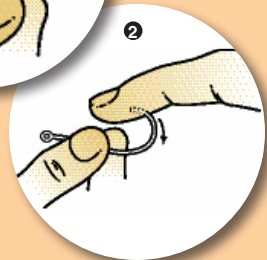
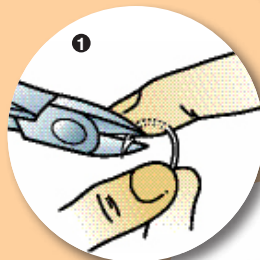
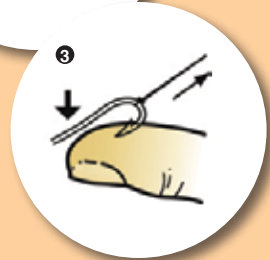
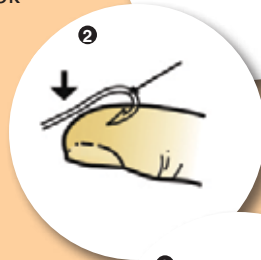
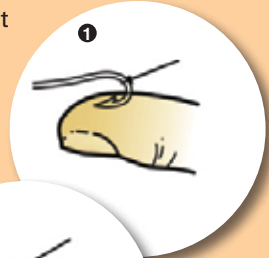

Cleaning, Filleting, and Cooking Fish

There are as many recipes for cooking a freshly caught fish as there are anglers. Proper cleaning and preparation of a fish before cooking will help ensure success with whatever cooking method you choose.

Responsibly dispose of all fish entrails, skeletons, and other remains. If you are on a camping or hiking trip, follow Leave No Trace principles, and treat this waste as you would human waste.

Cleaning Fish

Following these step-by-step instructions for cleaning a fish will make this messy task more manageable.

Step 1—Cover the area with brown paper or newspaper. Keep a plastic bag handy for any waste. Make sure you have a sharp knife.

Step 2—Rinse the fish under clean, cool water.

Step 3—Skin the fish, or remove the scales using a scale remover or sharp knife. (Hold the fish firmly by the head and run the dull edge of your knife from tail to head until the fish feels slick.) If you skin the fish, it won't need to be scaled. To skin the fish, cut down the backside and loosen the skin around the fins. Remove the skin with pliers; pull the skin down from head to tail and cut it off at the tail.

Step 4—Starting at the anal opening near the tail, cut through the belly to the gills.

Step 5—Open the belly and remove the entrails and gills from the fish. (Don't burst the stomach.) Scrape out the kidney line (it is reddish-brown) along the underside of the backbone.

Step 6—If you want, remove the head by carefully cutting down through the backbone.

Step 7—Remove the tail and pull off the dorsal fin (along the top of the fish) with a quick tug.

Step 8—Rinse the fish well under cool running water.

Filleting Fish

Keep in mind that not all fish should be filleted. A trout, for instance, needs only to be cleaned. Removing the meat of some fish from the bones and skin makes it easier to cook and to eat. Here is one way to do it.

Step 1—Lay the fish on its side and make a cut just behind the gills down to the backbone, but not through it.

Step 2—Start at the cut made in step 1 and run the point of the knife alongside the backbone, down to where it starts to click along the tops of the ribs. Cut alongside the ribs, working back toward the tail until the entire side of the fish is free from the ribs and backbone, but leave it attached to the tail.

Step 3—Lay the side flat and hook a forefinger under the skin near the tail. Run the knife into the meat next to the skin and hold the blade against the inside of the skin at an angle of about 45 degrees. Holding the blade steady, gently lift the forefinger holding the skin and pull. The skin will slide out, leaving a boneless, skinless fillet. Repeat on the other side of the fish, and you will have two fillets.

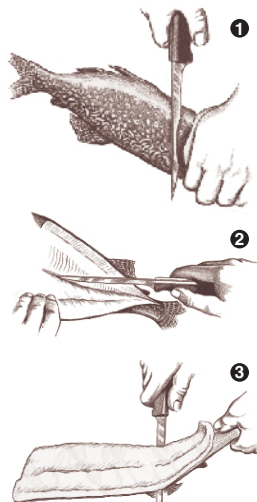

Removing Bones From a Pike

All members of the pike family are excellent eating. However, they all have rows of **Y bones** embedded in the meat along the back. Getting these bones out takes some further work with the fillet knife.

Step 1—In the illustration, a pike fillet is cut into four sections. The tail section has no Y bones and is set aside. The arrow points to the tops of the Y bones that can be felt by running a fingertip along the fillet.

Step 2—The side view in the illustration shows a cut (dotted line) alongside the Y bones. This piece of boneless meat is saved.

Step 3—The second cut is just behind the Y bones, severing them from the rest of the fillet. The piece with the bones is discarded. All that remains is good, boneless meat.

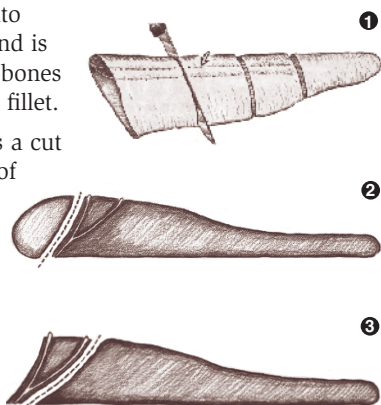

Cooking Fish

There are dozens of ways to cook fish. The following recipes can be prepared at home or on the trail.

Get rid of that fishy smell on your hands by rubbing them with half a lemon and then washing with soap and water.



Fish Chowder

To make fish chowder, begin by cutting about 2 pounds of fillets into pieces an inch or so square. Brown half a pound of diced bacon in a large pot, then add a couple of diced onions and four to six diced potatoes. Salt and season the fillets, and lay the fish on top of the mixture. Fill the pot with water just up to the top of the fish and bring it to a boil. Place 2 teaspoons of pickling spice in a cheesecloth bag, tie a string around it, and hang it in the pot. Allow the liquid to simmer for one hour. Then remove the spice bag and add about a quarter-cup of margarine or butter and 2 cups of milk. Stir to mix all the ingredients and then serve.

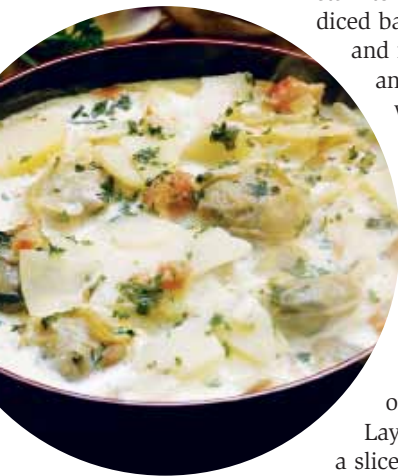

Foil-Baked Fish

Place a whole fish or large fillet inside a sheet of heavy aluminum foil. Salt and pepper the fish. Lay two strips of bacon over the top of the fish. Add a slice of lemon, if you wish. Fold the foil lengthwise into a pouch, then fold over the edges, sealing them. Take another sheet of foil and do the same, giving the fish a double layer. Bake in an oven or on hot coals for 20 to 30 minutes, depending on the size of the fish.



The trick to turning out tasty fried fish is to have enough hot cooking oil and some type of batter or breading to seal the meat so that the fish cooks quickly without absorbing the oil.

Fried Fish

Allow the fillets to drain on a paper towel or similar absorbent material until they are fairly dry. Salt the fillets, then mix a pancake batter or batter made of one egg and 1 cup of self-rising flour. Add a bit of milk to thin the batter. Do not make the batter too thin. You also can bread the fish by dipping the fillets in beaten eggs thinned with milk and then rolling them in seasoned cracker crumbs or cornmeal.

To cook the fish, make sure the oil in the frying pan is sizzling hot. Then dip each fillet in the batter and drop it into the oil, being very careful not to splatter the hot oil. When one side of the fillet is brown, flip it over and brown the other side. Remove from the oil and allow the fish to cool a little on a paper towel. Serve hot.

Poached Fish

Poached fish is easy to cook and easy on the digestion. Salt some fresh fish fillets and set them aside. Then melt a little butter in a frying pan. Add a half-inch of milk to the bottom of the pan. Heat the milk until it steams, but do not boil it. Add the salted fish fillets, cover the pan, and let the fish simmer for 10 minutes. Remove and drain the fish. A dash of paprika is a nice finishing touch.





Protecting Game Fish Resources

The United States has a well-run and healthy recreational fishery. Combined with state fishing license revenue, more than \$1 billion is invested each year to support a recreational fishing industry that has a combined annual value of more than \$100 billion.

Obeying Fish and Game Laws

With millions of anglers fishing the nation's waterways, it is necessary for the taking of fish to be regulated so that fish populations do not decline. State conservation departments seek laws that will balance fish production with the harvest. Trained conservation officers patrol the waterways to see that the laws are followed.

Limits. Each state puts a limit on the number of game fish of each species that may be taken by an angler at one time. Limits vary in direct proportion to the availability of the fish. More scarce species have a much lower limit. Muskellunge, for instance, in many states are limited to one a day. Panfishes, which are prolific and numerous, have much higher limits or no limits at all. Some areas may have regulations for the catch and release of some species. An ethical angler will adhere to both the letter and the spirit of the law.



Methods. As fishing has evolved from being mainly a method for gathering food into a sport, rules of sportsmanship have been incorporated into the regulations. Game fish must be taken on hook and line and cannot be speared or netted except with a landing net. In some areas, trout may be taken only on artificial flies. Where salmon and steelhead trout migrate up streams to spawn, only single hooks may be used on lures to prevent unscrupulous fishermen from trying to snag fish with treble hooks. In many areas, only one lure or bait may be used on one line, and only one line is allowed for each angler.

Seasons. To protect fish while spawning, seasons are set so that game fish can lay their eggs without interference. For species such as bass, pike, and walleye, the seasons open after spawning ends in the spring. For lake trout, brook trout, and other fall-spawning species, the seasons are closed in late autumn, just before spawning starts. When fish are spawning, they are particularly vulnerable because they savagely strike to protect their eggs.

Failure to know and obey the fish and game laws can lead to an arrest and a stiff fine. True sports enthusiasts never **poach** or consider breaking the rules. Many states have a TIP (Turn In Poachers) hotline telephone number that can be called to report violations. People who break the fish and game laws are stealing from their fellow outdoor enthusiasts and demonstrating a lack of concern for wildlife and the environment.

Information. Most marine docks and shops that sell tackle and bait and issue fishing licenses also supply information about local fishing regulations. You might also check with local or district fish and game offices or their Web sites. Be aware that in some cases you may need to obtain a special license in addition to a basic fishing license.

Many states offer online purchase of fishing licenses and other required permits.





Fish Resource Management

All states maintain a staff of trained fisheries personnel who conduct research on the resources and determine how to best spend the sports enthusiast's fishing license money to get the best results. To determine fish populations, test nets are set and captured. Then fish are tallied as to numbers, age, and growth rates. Where fish numbers are low, either through heavy fishing or for natural reasons, stocking takes place with fry, fingerlings, and yearling fish from state or federal hatcheries.

However, it was discovered that merely adding fish to many lakes and streams did not improve the fishing, thus research has become an important tool. The nation's fishing tackle manufacturers and sportspeople, acting together, got the U.S. Congress to pass a tax on all fishing tackle made and sold in the country. Named for its sponsors in Congress, the Dingall-Johnson Sport Fish Restoration tax money generates hundreds of millions of dollars each year and is apportioned among the states for scientific studies and other related fishing-management practices.

Skilled aquatic biologists use chemistry, electronics, and other aids to determine which species of fish each lake and stream can best support. As the sport of fishing grows, our ability to provide adequate populations will depend more and more on research studies and programs provided by skilled technicians.

The Future of Sportfishing

All anglers sooner or later discover that it is not enough to enjoy the sport of fishing and the tasty fish dinners that go with it. All fishermen find that they have a responsibility to their sport and to the environment in which the fish live. In our modern, complex society, humans have life-and-death control over the waters. How we treat those waters and their resources determines the abundance of game fish and the future of the sport.



Entire rivers and lakes have been emptied of preferred game fish because of human-caused pollution or construction of small- and large-scale dams. Likewise, there have been many instances of rivers and lakes reclaimed because anglers and other outdoor enthusiasts banded together and demanded it. Boy Scouts have been active in cleaning up trash from rivers and in assisting state fisheries personnel in the rehabilitation of streams for game fish species. Because Scouting is based on outdoor experiences, Scouts have always had a high regard for maintaining a quality environment.

As long as we as a nation take care of our water resources, we will always have game fish for sport and for the table. In a real sense, when we protect the waterways we also are protecting our own future. Our fate and the fate of fish are inseparable—but only we are able to do something about it.

Outdoor Code

The BSA's Outdoor Code helps stimulate awareness by Scouts of the need for every user of the outdoors to be a responsible patron of outdoor resources.

**As an American, I will do my best to—
Be Clean in my Outdoor Manners.**

I will treat the outdoors as a heritage. I will take care of it for myself and others. I will keep my trash and garbage out of lakes, streams, fields, woods, and roadways.

Be Careful With Fire.

I will prevent wildfire. I will build my fires only when and where they are permitted and appropriate. When I have finished using a fire, I will make sure it is cold out. I will leave a clean fire ring, or remove all evidence of my fire.

Be Considerate in the Outdoors.

I will treat public and private property with respect. I will follow the principles of Leave No Trace for all outdoor activities.

Be Conservation-Minded.

I will learn how to practice good conservation of soil, waters, forests, minerals, grasslands, wildlife, and energy. I will urge others to do the same.

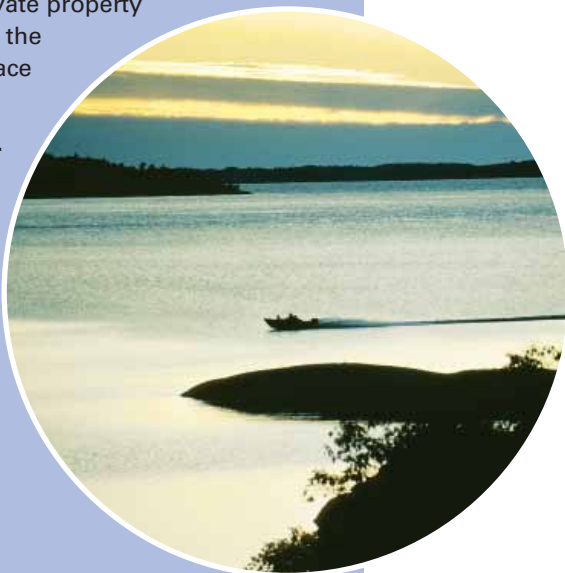

Leave No Trace

To ensure a healthy future for ourselves and our environment, we must do more than simply pick up litter. We must learn how to maintain the integrity and character of the outdoors. Leave No Trace is a set of rules but it is also an awareness and an attitude. Along with the Outdoor Code, the seven Leave No Trace principles offer guidelines to follow at all times. These guidelines apply to fishing as well as hiking, camping, or any other outdoor activity.

1. Plan Ahead and Prepare. Proper planning and preparation for a fishing trip helps ensure a safe and enjoyable experience while minimizing damage to natural and cultural resources. Anglers who plan ahead can avoid unexpected situations and minimize their impact by complying with area game and fish laws, such as size and catch limits, tackle and bait regulations, and seasonal restrictions. Failure to know and obey these laws can lead to an arrest and a fine. Be sure to obtain a fishing license if necessary and any other needed permits or permission before heading out on your fishing adventure.

Obtain information concerning geography, water levels, and weather where you plan to fish so that you are not caught off guard by a storm or rugged terrain. Allow ample time to travel to and from your desired fishing spot, whether on the water or the shore. Take along the proper equipment and tackle for the type of fishing you plan to do. It is also helpful to schedule your outing to avoid times of high use.

If fishing on the water, be sure to use the appropriate boat launch location.

2. Travel and Camp on Durable Surfaces. Whether you fish for a few hours or an entire day, or you plan to camp and fish, it is important to minimize your impact on the land. Damage to land occurs when visitors trample vegetation or communities of organisms beyond recovery. The resulting barren areas develop into undesirable trails, campsites, and fishing spots and cause soil to erode. If fishing from shore in high-use areas, concentrate activity where vegetation is already absent. Minimize resource damage by using existing trails and selecting designated or existing fishing areas.

If camping overnight, always camp at least 200 feet from shorelines. Keep campsites small by arranging tents in close proximity. If you are camping and cooking that day's catch, disperse tents and cooking activities. Move camp daily to avoid creating permanent-looking campsites. Always choose the most durable surfaces available: rock, gravel, sand, compacted soil, dry grasses, or snow.



Using a float tube or waders is a good way to minimize your impact. These devices leave little or no lasting impact and allow you better access to the fish.

It is especially important to avoid impacting stream banks and lakesides. The area that is immediately adjacent to a stream or river is called the riparian zone. These zones supply food, cover, and water for a diverse number of animals, both in and out of the water. They also serve as migration routes and forest connectors between habitats for a variety of wildlife, especially birds. In addition, riparian zones generally contain more diversity and are more productive in plant growth and animal species than land farther away from the water.

These guidelines apply to most alpine settings and may be different for other areas, such as deserts. Learn the Leave No Trace techniques for your specific activity or destination. Check with land managers to be sure of the proper technique.

3. Dispose of Waste Properly. Pack it in; pack it out. This simple yet effective saying motivates outdoor visitors to take their trash home with them. Inspect your fishing spot, boat, or campsite for trash or spilled foods. Accept the challenge of packing out all trash, leftover food or bait, and used or broken fishing line. Use designated fish cleaning areas or check with the local game and fish officials if you will be fishing in a more remote area.

You must properly dispose of any fish entrails or bodily waste in solid waste facilities or by burying them in a cathole. A cathole should be dug 6 to 8 inches deep in humus soil and should be at least 200 feet from water, trails, and campsites.

If cooking in the backcountry, strain food particles from the dishwater and disperse the wastewater at least 200 feet from springs, streams, and lakes. Pack out the strained food particles. Use biodegradable soap 200 feet or more from any water source.



Remember that you should never release live bait or bait water into a lake or stream. You might unknowingly introduce nonnative species or disease.



Never leave used fishing line to decompose. Monofilament line can persist in the environment for many years, so make every effort to retrieve broken line and snagged hooks. Dispose of used or broken line responsibly by packing it out with the rest of your trash.

4. Leave What You Find. Allow others a sense of discovery, and preserve the past. Leave rocks, plants, animals, archaeological artifacts, and other objects as you find them. Examine but do not touch cultural or historical structures and artifacts that you may stumble across. It may be illegal to remove artifacts.



Good fishing spots are found, not made. Avoid altering a site, digging trenches, or building structures. Never hammer nails into trees, hack at trees with hatchets or saws, or damage bark and roots by tying horses to trees for extended periods. Replace surface rocks or twigs that have been cleared from the fishing spot or campsite. On high-impact sites, clean the area and dismantle inappropriate user-built facilities such as log seats or tables and multiple fire rings.



Never transfer fish from one watershed to another. This can cause the spread of disease and invasive species.

5. Minimize Campfire Impacts. If you plan to cook what you catch while on a fishing trip, consider the potential for resource damage. Some people would not think of cooking or camping in the outdoors without a campfire. Yet the naturalness of many areas has been degraded by overuse of fires and increasing demand for firewood. A low-impact alternative is to use a lightweight camp stove. Stoves are fast, eliminate the need for firewood, and make cleanup after meals easier.



Practice catch-and-release fishing to help ensure quality fishing for future anglers. The motto, "Limit your kill; don't kill your limit" should be part of every Leave No Trace experience.

If you build a fire, keep it small. Whenever possible, use an existing fire ring and dead and downed wood that can be broken easily by hand. Choose not to have a fire in areas where wood is scarce, and when possible, burn all wood to ash and remove all unburned trash and food from the fire ring. Be certain all wood and campfire debris is cold out.

6. Respect Wildlife. Help keep wildlife wild. While fishing, chances are you will encounter other wildlife as well, on the shore or in the water. Avoid disturbing animals by observing them from afar and giving them a wide berth. You are too close if an animal alters its normal activities. Never feed wildlife (except the fish you're trying to catch, of course!).

Store food and garbage securely to avoid attracting wildlife. Be respectful of any catch-and-release areas, and return unharmed to the water any fish that you do not plan to eat or that exceed the designated limit.

7. Be Considerate of Other Visitors. Thoughtful anglers respect other visitors and protect the quality of their experience. The following are a few tenets of outdoor ethics:

- Travel in small groups. If camping, do so in groups no larger than that prescribed by the land managers.
- Let nature's sounds prevail. Keep the noise down and leave radios, music players, and pets at home. Fish can be spooked by such interruptions. In bear country, however, being a bit talkative on the trail might help prevent a surprise encounter with a bear.
- Select fishing spots and campsites away from other groups to help preserve their solitude and their chances of catching fish.
- Always travel quietly to avoid disturbing other visitors. If fishing from a watercraft, take care not to disturb other anglers' efforts on the water.
- Respect private property and leave gates (open or closed) as found.

The Leave No Trace principles might seem unimportant until you consider the combined effects of millions of outdoor visitors. With a 750 percent increase in the use of designated wilderness areas over the last 30 years, leaving no trace is everyone's responsibility. Use judgment and experience to tailor outdoor activities to the environment. Forest, mountain, seashore, plains, freshwater, and wetland environments all require different minimum-impact practices. Whether outdoors for sport or leisure, you are nature's guest; remember to act accordingly while there.

Glossary

auger. A tool used in ice fishing to bore holes in the ice.

balance. The state in which the rod, reel, and line are correctly matched to handle a given-weight lure or bait. Balance allows an angler to deliver the lure or bait with accuracy within any desired distance.



Bobber

bass bug. A type of bass lure made to resemble bugs, frogs, mice, or anything else edible that might fall into the water. It is tied with cork or hair bodies so that they will float easily.

bobber. Known formally as a float, a bobber usually is made of plastic. It is clipped to the line and holds the hook and bait at a predetermined depth; it bobs, or moves, when a fish bites.

boil. An eruption on the water's surface caused by minnows skipping from the water in an attempt to escape fish below on the feed. Boils are a signal of the presence of game fish.

creel. A canvas bag or willow basket made to hold trout that have been gilled and gutted.

downrigger. A wire line with heavy lead weights used to get lures deep when trolling for lake trout and salmon.

fishhook. A barbed or barbless steel wire hook used to catch fish.

fly. A type of lure made of hair, feathers, wool, chenille, or other materials and held together with thread and glue. A fly is hand-tied to represent insects, bait fish, or other natural food items.

fly-fishing. A method of fishing in which an artificial fly and a long flexible rod, reel, and line are used.

jig. A hook with a weight molded into the head. Also called a leadhead.

landing net. A net used to land, or bring in, a fish; it helps ensure that the fish will not slip and get loose.

level fly line. Inexpensive fly line that may be used for trolling. Generally not recommended for fly casters.



Creel



Landing net

lure. Artificial bait used for catching fish.

plug. A type of artificial lure that usually resembles a minnow or frog and is made of plastic. It is available in three different styles: floating-diving, deep-running, and surface.

poach. To kill or take game or fish illegally.

rig. The terminal tackle used for live bait fishing.

sinker. A weight used to sink the bait down to the fish. There are various types designed for different types of fishing. Sinks are typically made of lead but environmentally friendly versions are made of alternative materials such as rock, ceramics, iron, steel, and bismuth.

spinners. A type of thin, metal lure that has a hole drilled in one end and is mounted on a strip of wire. It is usually rigged up with hair flies, feather streamers, or live bait.

spinning. A form of casting that uses a fixed-spool reel and a spring-operated pickup arm; the line is controlled with the index finger of the casting hand. Long casts can be made effortlessly because there is no movable spool. Also called spin-casting.

spoon. A shiny metal lure that imitates minnows by creating wobbling actions in the water; it is shaped like the lower part of a teaspoon.

stringer. A string, wire, or chain (often with snaps) used to string fish on the side of a boat and keep them alive in the water.

swivel. A device that connects to a hook, lure, or leader and allows the bait to revolve without twisting the line.

tackle. A general term for fishing equipment such as the rod, reel, line, lures, etc.

tackle box. A carrying case for lines, leaders, hooks, lures, reels, and other pieces of fishing equipment.

tapered fly line. Used for fly-fishing, this type of line is thicker in the middle and tapered on the ends. The tapered diameter aids in casting light flies and having them land lightly on the water.

weight-forward fly line. Used for fly-fishing, this type of line is heaviest near the terminal end, just before the leader. It gives added weight to cast large streamer flies or cork-bodied bass bugs.

Y bones. The bones that lie embedded in the meat along a pike's spine; they are shaped like the letter Y.



Lure



Spinners



Stringer



Tackle box

Fishing Resources

Scouting Literature

Boy Scout Handbook, Conservation Handbook, and Fieldbook; Camping, Cooking, Environmental Science, First Aid, Fish and Wildlife Management, Fly-Fishing, Lifesaving, Soil and Water Conservation, and Swimming merit badge pamphlets

Visit the Boy Scouts of America's official retail Web site (with your parent's permission) at <http://www.scoutstuff.org> for a complete listing of all merit badge pamphlets and other helpful Scouting materials and supplies.

Books

Baron, Frank P. *What Fish Don't Want You to Know: An Insider's Guide to Freshwater Fishing*. Ragged Mountain Press, 2004.

Bashline, Sylvia. *The New Cleaning & Cooking Fish: The Complete Guide to Preparing Delicious Freshwater Fish*. Creative Publishing International, 1999.

Circle, Homer. *Bass Wisdom*. The Lyons Press, 2000.

Earnhardt, Tom. *Boats for Fishermen*. The Lyons Press, 2001.

Kaminsky, Peter. *Fishing for Dummies*. IDG Books Worldwide, 1997.

Maas, Dave. *Kids Gone Fishin'*. Creative Publishing International, 2001.

National Audubon Society. *National Audubon Society Field Guide to North American Fishes*. Knopf, 2002.

Pfeiffer, C. Boyd. *The Complete Book of Tackle Making*. The Lyons Press, 1999.

Rosko, Milt. *The Complete Book of Saltwater Fishing*. Krause Publications, 2001.

Schultz, Ken. *Ken Schultz's Fishing Encyclopedia: Worldwide Angling Guide*. IDG Books Worldwide, 2000.

Sousa, Robert J. *Learn to Fly Fish in 24 Hours*. Ragged Mountain Press, 2006.

Vick, Noel. *Fishing on Ice*. Human Kinetics Publishers, 1999.

Wilson, Geoff. *Geoff Wilson's Complete Book of Fishing Knots and Rigs*. Australian Fishing Network, 2006.

DVD

Joan Wulff's *Dynamics of Fly Casting*. Miracle Productions, 2001.

Periodicals

Field and Stream and Outdoor Life magazines

Telephone: 800-289-0639 (*Field and Stream*); 800-365-1580 (*Outdoor Life*)
Web site: <http://fieldandstream.com> or
<http://outdoorlife.com>

Organizations and Web Sites

American Sportfishing Association and Future Fisherman Foundation

225 Reinekers Lane, Suite 420
Alexandria, VA 22314
Telephone: 703-519-9691
Web sites: <http://www.asafishing.org>
and <http://www.futurefisherman.org>

The Catch and Release Foundation

19 Parmalee Road
Newtown, CT 06740
Toll-free telephone: 800-63-CATCH
Web site:
<http://www.catchandreleasefound.org>

Catskill Fly Fishing Center and Museum

P.O. Box 1295
Livingston Manor, NY 12758
Telephone: 845-439-4810
Web site: <http://www.cffcm.net>

Federation of Fly Fishers

P.O. Box 1688
Livingston, MT 59047
Telephone: 406-222-9369
Web site: <http://www.fedflyfishers.org>

Izaak Walton League of America

707 Conservation Lane
Gaithersburg, MD 20878
Telephone: 301-548-0150
Web site: <http://www.iwla.org>

National Oceanic and Atmospheric Administration Fisheries

1315 East West Highway
Silver Spring, MD 20910
Telephone: 301-713-2334
Web site: <http://www.nmfs.noaa.gov>

National Park Service

1849 C St., NW
Washington, DC 20240
Telephone: 202-208-6843
Web site: <http://nps.gov>

Trout Unlimited

1300 N. 17th St., Suite 500
Arlington, VA 22209-2404
Telephone: 703-522-0200
Web site: <http://www.tu.org>

U.S. Fish and Wildlife Service

Main Interior
1849 C St., NW
Washington, DC 20240-0001
Web site: <http://www.fws.gov>

The Federation of Fly Fishers, International Game Fish Association, and Trout Unlimited have each signed a memorandum of mutual support with the Boy Scouts of America that emphasizes an ongoing relationship to promote mutually beneficial programs for recreational fishing.

Acknowledgments

The Boy Scouts of America thanks Douglas Precourt; Robert J. Sousa, Ph.D., U.S. Fish and Wildlife Service (retired); and Ben Jelsema, volunteer Scouter, for preparing this revised version of the *Fishing* merit badge pamphlet. While all three are avid anglers, Sousa and Jelsema have put in countless hours over the past several years as coordinators of the fishing exhibits at the last three national Scout jamborees. Thanks also to Howard Kern, Master Leave No Trace Trainer, for his valuable assistance.

We are grateful to Howard E. Evans, Ph.D., and Edward Brothers of Ithaca, N.Y., for their expertise and invaluable input, and to Bob Cary, who wrote and illustrated the previous edition of the pamphlet, upon which this edition was based. Several of his illustrations remain in this edition. Thanks also to Trout Unlimited for its support.

Photo and Illustration Credits

Brand X Pictures, Bugs and Insects CD—page 74 (*top*)

HAAP Media Ltd., courtesy—cover (*background*)

Jupiterimages.com—page 11

Photos.com—cover (*bobber*); pages 2–5 (*all*), 8–9 (*both*), 12 (*top*), 13 (*both*), 14 (*left*), 16 (*both*), 17 (*top*), 18, 22, 23 (*bottom two*), 25 (*top*), 26 (*top*), 28 (*top*), 31 (*bottom*), 32 (*top*), 36, 44, 51 (*top*), 62, 66 (*top*), 71 (*top*), 72, 78 (*both*), 79 (*right*), 80–82 (*all*), 84–85 (*all*), 87, 89 (*both*), and 92 (*center*)

USDA Agricultural Resource Service/
Scott Bauer, Bugwood.org, courtesy
—page 74 (*bottom two*)

U.S. Fish and Wildlife Service, courtesy
—cover (*fish, bottom left*); pages 15, 21 (*both*), and 83

U.S. Fish and Wildlife Service/Duane Raver—pages 23 (*top*), 24 (*all*), 25 (*bottom*), 26 (*bottom*), 27 (*bottom*), 28 (*bottom*), 31 (*top two*), and 35 (*all*)

U.S. Fish and Wildlife Service/Timothy Knepps, courtesy—cover (*fish, bottom left*); page 30 (*both*)

Wikipedia.org, courtesy—page 27 (*top*)

Wikipedia.org/Gunter Küchler, courtesy
—page 29 (*bottom*)

All other photos and illustrations not mentioned above are the property of or are protected by the Boy Scouts of America.

Dan Bryant—cover (*stringer, landing net, pencil bobber, floating dive plug, spoon, three-way swivel, tackle box, jig*); pages 43 (*bottom*), 50 (*all*), 51 (*bottom three*), 52 (*all*), 55–58 (*all*), 59 (*top three*), 63–64 (*all*), 88 (*top*), 92 (*top, bottom*), and 93 (*all*)

John McDearmon—all illustrations on pages 10 (*both*), 39–43, 45–49, 60 (*surf rig, fish-finder rig*), 61 (*all*), 75 (*all*), and 77 (*all*)

Brian Payne—pages 17 (*left*), 20, 32 (*bottom*), 34, 38, 65, 66 (*bottom*), and 70

Randy Piland—pages 79 (*top*) and 88 (*bottom*)

Julie Zickefoose—illustrations on pages 11–12 (*both*), 14, and 19

MERIT BADGE LIBRARY

Though intended as an aid to Boy Scouts, Varsity Scouts, and qualified Venturers in meeting merit badge requirements, these pamphlets are of general interest and are made available by many schools and public libraries. The latest revision date of each pamphlet might not correspond with the copyright date shown below, because this list is corrected only once a year, in January. Any number of merit badge pamphlets may be revised throughout the year; others can simply reprinted until a revision becomes necessary.

If a Scout has already started working on a merit badge when a new edition for that pamphlet is introduced, he may continue to use the more recent badge pamphlet to earn the badge and fulfill the requirements therein. In other words, the Scout need not start all over again with the new pamphlet and possibly revised requirements.

| Merit Badge Pamphlet | Year | Merit Badge Pamphlet | Year | Merit Badge Pamphlet | Year |
|---------------------------|------|---------------------------|------|------------------------|------|
| American Badminton | 2002 | Engineering | 2002 | Photography | 2005 |
| American Dances | 2005 | Entrepreneurship | 2002 | Planting | 2002 |
| American Hallmarks | 2005 | Environmental Science | 2002 | Plant Science | 2005 |
| American Letter | 2002 | Family Life | 2005 | Planting | 2004 |
| Animal Science | 2002 | Food Mechanics | 2002 | Pottery | 2002 |
| Antennology | 2002 | Flower Printing | 2002 | Public Health | 2005 |
| Antiquary | 2004 | Flint Safety | 2004 | Public Speaking | 2002 |
| Antiquities | 2002 | First Aid | 2007 | Pulp and Paper | 2002 |
| Art | 2002 | Fish and Wildlife | 2004 | Rails | 2002 |
| Astronomy | 2004 | Management | 2002 | Radio | 2002 |
| Autism | 2002 | Painting | 2002 | Scouting | 2002 |
| Autism/Aspergers | 2002 | Ry-Fishing | 2002 | Scouting and | |
| Aviation | 2002 | Forestry | 2005 | Amplifier Study | 2005 |
| Backpacking | 2007 | Stairing | 2002 | Site Planning | 2004 |
| Balistics | 2002 | Statistics | 2005 | Swimming | 2002 |
| Bird Study | 2005 | Stonemasonry | 2005 | Tailoring | 2002 |
| Boating (non Motor) | | Stonemasonry | 2002 | Tenting | 2002 |
| Camping | 2005 | Graphic Arts | 2002 | Teambuilding | 2004 |
| Camping | 2004 | Hiking | 2007 | Tenting | 2007 |
| Chemistry | 2004 | Home Repair | 2002 | Trick Gun Shooting | 2005 |
| Chromatography | 2002 | Household | 2002 | Trouting | 2005 |
| Citizenship in the | | Indian Lore | 2002 | Trout and Bass Fishing | 2004 |
| Community | 2005 | Insect Study | 2002 | Trout Specks | 2007 |
| Citizenship in the Nation | 2005 | Journalism | 2002 | Truck and Motor | |
| Citizenship in the World | 2005 | Landscape Architecture | 2002 | Conversion | 2004 |
| Climbing | 2002 | Law | 2002 | Space Exploration | 2004 |
| Coin Collecting | 2002 | Leisurecraft | 2002 | Sports | 2002 |
| Collection | 2002 | Lithography | 2002 | Stamp Collecting | 2007 |
| Communications | 2002 | Mounting Study | 2002 | Survival | 2004 |
| Composite Materials | 2002 | Modeling | 2002 | Swimming | 2002 |
| Computers | 2005 | Modeling | 2007 | Tactics | 2002 |
| Cooking | 2007 | Model Design and Building | 2002 | Teambuilding | 2005 |
| Cross Fertilization | 2005 | Modeling | 2002 | Tenth Safety | 2002 |
| Cycling | 2002 | Music and Singing | 2002 | Track Transportation | 2005 |
| Dairymaking | 2002 | Motor | 2002 | Voluntary Medicine | 2005 |
| Databases/American | 2005 | Member Service | 2004 | Water Sports | 2007 |
| Day Care | 2002 | Orientation | 2002 | Weather | 2002 |
| Drilling | 2002 | Orientation | 2002 | Whitewater | 2005 |
| Etching | 2004 | Painting | 2002 | Whitewater Survival | 2007 |
| Etching | 2004 | Personal Fitness | 2002 | Wood Carving | 2002 |
| Emergency Preparedness | 2002 | Personal Management | 2002 | Woodwork | 2002 |
| Energy | 2005 | Pole | 2002 | | |

BOY SCOUTS OF AMERICA • SUPPLY GROUP

NATIONAL DISTRIBUTION CENTER

2300 Washington Boulevard
P.O. Box 7143
Charlotte, NC 28241-7143

www.scoutsusa.org

DIRECT MAIL CENTER

P.O. Box 908
Plyville, NC 28134-0908
For local credit card orders—

VISA, MasterCard, American Express—
call BSA operators toll-free
1-800-823-0782



FLORIDA SEA BASE



PHILMONT SCOUT RANCH



NORTHERN TIER



EAGLE SCOUT

ON THE ROAD TO HIGH ADVENTURE

THE SUPPLY GROUP IS READY TO BE A PARTNER ON YOUR TRAIL TO EAGLE THROUGH HIGH ADVENTURE. THE ADVENTURE IS YOURS, AND WE ARE READY WITH THE GEAR YOU WILL NEED. YOU CAN DEPEND ON THE LATEST IN LIGHTWEIGHT, DURABLE, QUALITY GEAR THAT WILL MEET AND SURPASS YOUR TOUGHEST REQUIREMENTS.



WWW.SCOUTSTUFF.ORG

SKU 35820



35899

2009 Printing