

Troop 1292 #44A

MERIT BADGE SERIES

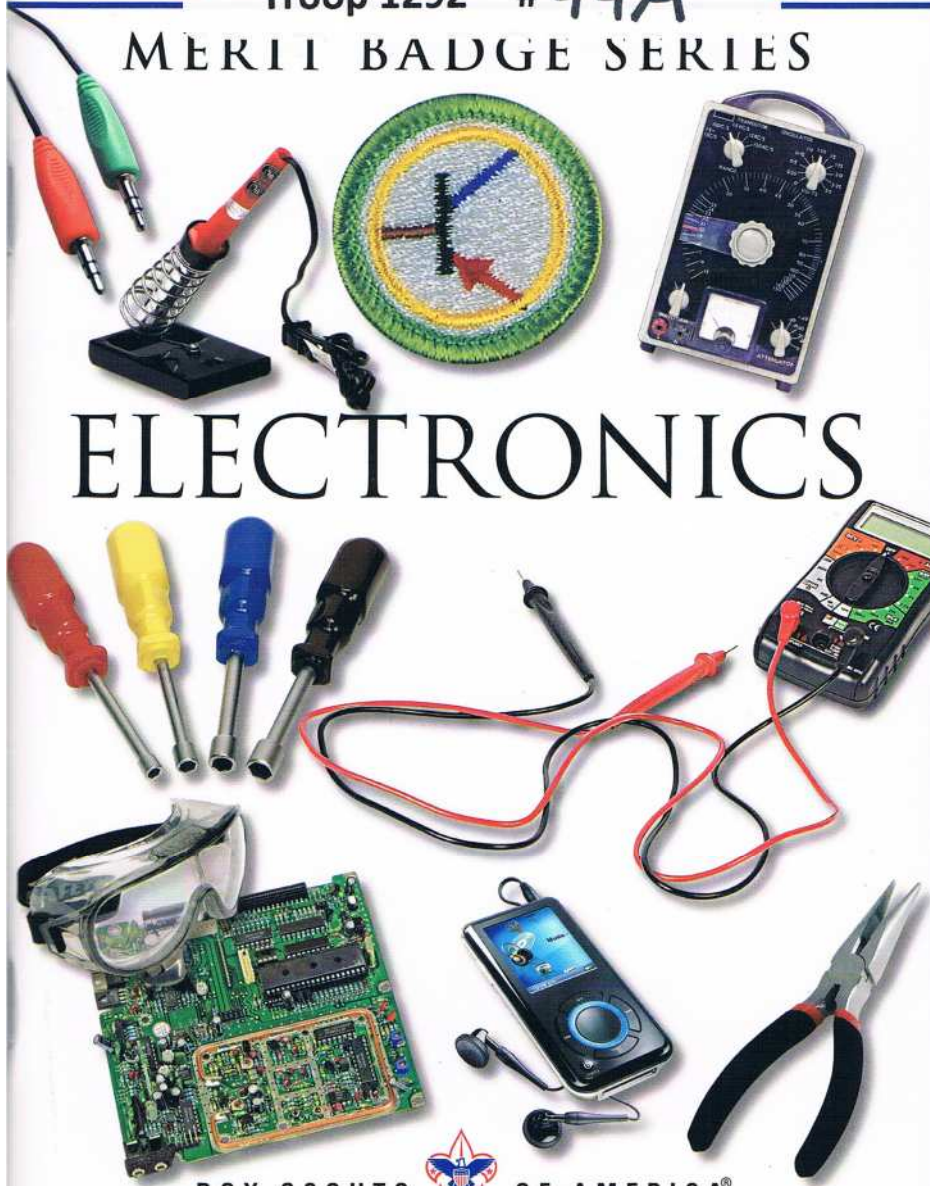

ELECTRONICS

BOY SCOUTS OF AMERICA®



HOW TO USE THIS PAMPHLET

The secret to successfully earning a merit badge is for you to use both the pamphlet and the suggestions of your counselor.

Your counselor can be as important to you as a coach is to an athlete. Use all of the resources your counselor can make available to you.

This may be the best chance you will have to learn about this particular subject. Make it count.

If you or your counselor feels that any information in this pamphlet is incorrect, please let us know. Please state your source of information.

Merit badge pamphlets are reprinted annually and requirements updated regularly. Your suggestions for improvement are welcome.

Send comments along with a brief statement about yourself to Boy Scout Division • Boy Scouts of America • 1325 West Walnut Hill Lane • P.O. Box 152079 • Irving, TX 75015-2079.

WHO PAYS FOR THIS PAMPHLET?

This merit badge pamphlet is one in a series of more than 100 covering all kinds of hobby and career subjects. It is made available for you to buy as a service of the national and local councils, Boy Scouts of America. The costs of the development, writing, and editing of the merit badge pamphlets are paid for by the Boy Scouts of America in order to bring you the best book at a reasonable price.

BOY SCOUTS OF AMERICA
MERIT BADGE SERIES

ELECTRONICS



BOY SCOUTS OF AMERICA®



Requirements

1. Describe the safety precautions you must exercise when using, building, altering, or repairing electronic devices.
2. Do the following:
 - a. Draw a simple schematic diagram. It must show resistors, capacitors, and transistors or integrated circuits. Use the correct symbols. Label all parts.
 - b. Tell the purpose of each part.
3. Do the following:
 - a. Show the right way to solder and desolder.
 - b. Show how to avoid heat damage to electronic components.
 - c. Tell about the function of a printed circuit board. Tell what precautions should be observed when soldering printed circuit boards.
4. Discuss each of the following with your merit badge counselor, and then choose ONE of the following and build a circuit to show the techniques used:
 - a. Tell how you can use electronics for a control purpose, and then build a control device circuit.
 - b. Tell about the basic principles of digital techniques, and then build a digital circuit. Show how to change three decimal numbers into binary numbers and three binary numbers into decimal numbers.

- c. Tell about three audio applications of electronics, and then build an audio circuit.

Show how to read the schematic diagram of the project you chose and, to the best of your ability, explain to your counselor how the circuit you built operates.

5. Do the following:
 - a. Show how to solve a simple problem involving current, voltage, and resistance using Ohm's law.
 - b. Tell about the need for and the use of test equipment in electronics. Name three types of test equipment. Tell how they operate.
6. Find out about three career opportunities in electronics that interest you. Discuss with and explain to your counselor what training and education are needed for each position.

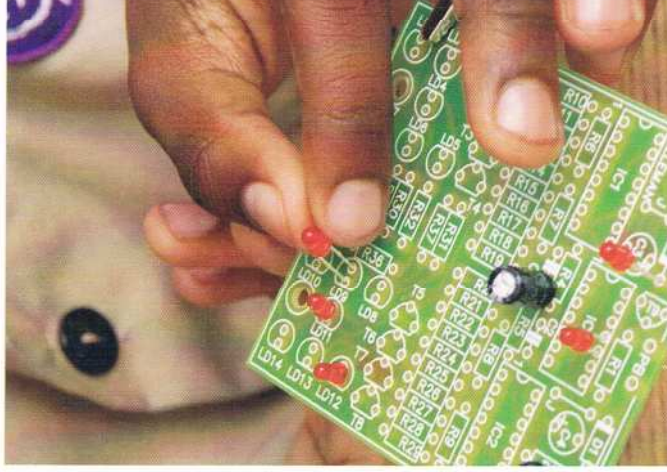

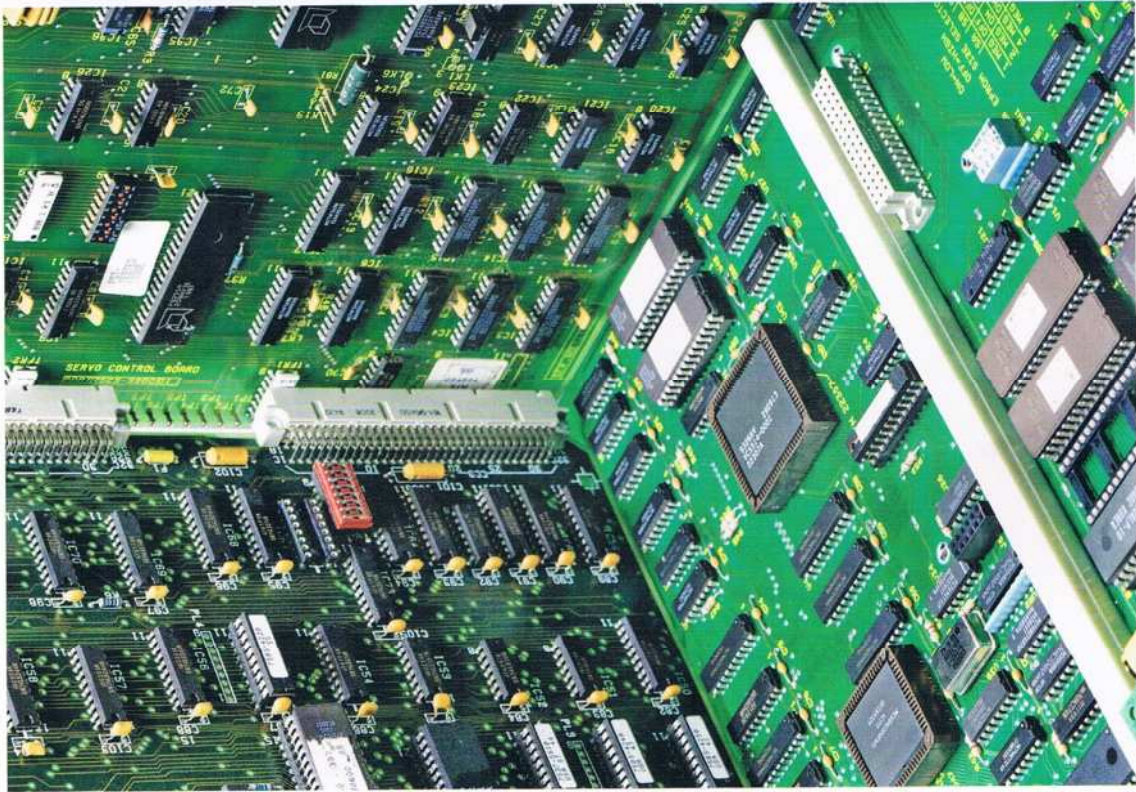

Contents

History and Introduction	7
Tools for Electronics Work	11
Basic Electronics Theory	15
Schematic Diagrams	29
Soldering	43
Control Devices	53
Digital Electronics	59
Audio	77
Electronic Test Equipment	83
Careers in Electronics	91
Electronics Resources	94

History and Introduction

Electronics is the science that controls the behavior of electrons so that some type of useful function is performed. (Electrons will be explained more fully later in this book.) Today, electronics is a fast-changing and exciting field.

The rapid growth of electronics started in the early 20th century when vacuum tubes were introduced and used to manipulate electronic signals. This was something that could not be done with the telegraph and telephone circuits or the high-voltage transmitters of those days. Vacuum tubes allowed weak radio and audio signals to be *amplified*, or to be made louder or stronger, and be sent on radio waves.

Vacuum tubes were an important breakthrough in electronics, but they had their limitations. For example, early computers using vacuum tubes were so large that one computer would fill an entire room. These computers had minimal processing power because, for one reason, the tubes needed a lot of power to function.

Electronics changed even more dramatically in 1948 when the *transistor*, a small, low-powered, solid-state electronic device, was invented. Transistors are smaller than vacuum tubes, require less power to function, and are more reliable. The development of the integrated circuit, or IC, advanced this technology further. ICs can contain tens of thousands of tiny transistors built onto a small piece of conducting material. This allows for the construction and production of complex electronic circuits, which are more efficient than tubes in processing electronic signals. ICs are used in many products today, including computers, audio equipment, cell phones, appliances, and automobiles.



Some people still collect old vacuum tubes and also antique radios, in which vacuum tubes were used.

How to Earn the Electronics Merit Badge

The first step in earning your Electronics merit badge is to discuss the requirements with your merit badge counselor.

To fulfill requirement 1, learn about the precautions you should take when using, building, altering, or repairing electronic devices. Many electronic *components* (parts) could be damaged if mishandled. Here are some basic safety precautions; there are more safety suggestions later in this pamphlet. As you read this pamphlet and work on the requirements, pay attention to safety and see whether you can add to this list.

Tips for Repairing Electronic Devices



1. Always wear safety goggles when working with electronic devices, especially when you are soldering.
2. Be careful about *electrostatic discharge*—that “zap” you feel after you run across a carpet in socks and then touch metal. This can be a big problem in your electronics work. It can actually set materials on fire and damage electronic components. Before handling components, touch a piece of metal to discharge any static electricity.
3. Don’t force a component into anything you are working with, and don’t overtighten anything.
4. Be careful when you are working with wires. Bending a wire too often or tightening one too tightly could cause it to break.
5. When inserting plugs and sockets, ease them in and out. Never force them. Be aware that some components must be installed a certain way.
6. Be careful when using tools such as pliers and cutters so that you don’t nick any wires or cut your fingers.
7. When bending component leads, don’t bend them too closely to the body of the component because the component will be strained.

For requirement 2, study the chapter called “Schematic Diagrams.” Choose a schematic diagram from this pamphlet, then copy it carefully with a pencil. Your drawing must show resistors, capacitors, and transistors or integrated circuits. Use the correct symbols for these components, label all parts, and be prepared to tell the purpose of each component. Show your drawing to your counselor and tell what you have learned.

For requirement 3, learn how to solder and then practice soldering and desoldering wires. When you think you are ready, show your soldering skills to your counselor. Be prepared to discuss soldering precautions, printed circuit boards, and possible heat damage to components when using a soldering iron.

Requirement 4 is demanding but fun because you will actually build a working electronics circuit. Choose your project carefully. Make sure that all the required parts are available at an electronics parts store, from a catalogue, or over the Internet (only with your parent’s permission). Also consider what tools you will need. You can choose a project other than those in this pamphlet, but check with your counselor first to make sure that the project is suitable. After you are done with the project, show it to your counselor, explain how it works, and show your ability to read the schematic diagram.

For requirement 4 you will also learn the basic principles of digital techniques, how you can use electronics for control purposes, and about audio applications. Learn the binary system so that you know how to change decimal numbers into binary numbers and binary into decimal.

For requirement 5, you will need to solve a simple problem using Ohm’s law. You also should be able to discuss test equipment, the different types, and what they’re used for.

For the final requirement, study three career opportunities in electronics that interest you. Discuss with your counselor the education and training needed for each.

Tools for Electronics Work

The basic tools you will need for most of your electronics work are shown here. You can probably find some around your home and get others at an electronics parts store.

Some Basic Tools



Slotted (flat-bladed) screwdriver



Phillips screwdriver



Nut driver





This multipurpose electrical tool removes insulation from wires before soldering. You also can use a hobby knife for stripping wires and trimming.



Cutting pliers, which cut either flush or diagonally, are for cutting wires and trimming leads you have soldered.



Long-nosed pliers are needed to bend the leads on components and hold wires or other parts while you solder.

Electronic parts are called *components*, which comes from the word meaning to *put together*. An electronic *circuit* is composed of several interconnected components. The *leads* on a component are insulated electrical conductors, such as wires, that connect to an electrical device.

For most projects, you can use any small-diameter solid or stranded hookup wire. Some projects might also require very small wire. A magnifier or magnifying work lamp is recommended for examining the circuit board to check solder connections. Most electronics parts stores have a selection of perforated circuit boards made specially for wiring electronics projects. Many come with small clips for mounting parts. These boards are ideal for building simple circuits.

You also will need an electric soldering iron, which you can buy at a hobby, electronics parts, or hardware store. The soldering iron in a beginner's tool kit should be a 15- to 40-watt iron with a fine chisel tip. Use 60/40 rosin-core solder (60 percent tin, 40 percent lead) that is marked for "electronic use." Never use acid core solder. Most of the solder you will need will have a diameter of 0.03 inch. You also should



Basic soldering kit, perforated boards

have a solder wick for desoldering a connection if you make a mistake or want to remove a component.

Use a workbench for your project if you have one. If not, you can use a kitchen table, desk, or sturdy card table. You will need to have good light and ventilation and access to power outlets. You also will need a few small boxes, trays, or jars to hold parts.

Get your counselor's approval before you start your project.

Buying Parts

Most electronics parts stores will have the components you will need for your project. If you do a project from scratch, you will have to buy the parts separately. While you also can buy a complete project as a kit, many electronics kits found in retail stores are not soldering kits, and building a project from scratch is challenging and rewarding. Scratch projects can be inexpensive if you can scrounge for most of the parts.

However, a kit has a number of advantages. All the necessary assembly instructions and parts are supplied, including wire and solder. Special parts, such as printed circuit boards, come with the kit. In addition, fewer tools are required because all necessary holes are prepunched. Since the kit has been carefully tested, you know that the finished product will work. A complete kit generally costs less than buying the parts separately. Investigate doing a project both ways before you invest your money.

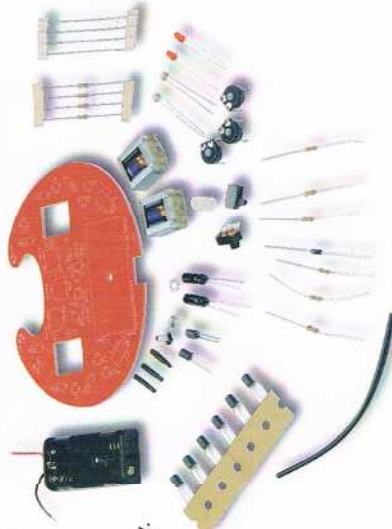

Kit project

Basic Electronics Theory

Before you learn about electronic components, let's look at the theory behind electronics. Controlling electrons is the science of electronics. So, our study of electronics theory begins with the electron.

Atoms and Electrons

To understand electrons, we must learn about the makeup of matter. All matter is composed of *atoms*, and an atom is composed of three elementary particles: *electrons*, *protons*, and *neutrons*. Negatively charged electrons revolve around the core (the *nucleus*) of the atom, which is composed of positively charged protons and neutral (not charged) neutrons.

Generally, a negatively charged electron is matched by a positively charged proton. For example, copper has 29 electrons revolving around a nucleus containing 29 protons. A basic law of nature controls electrical charges. This law simply stated is that *unlike charges attract and like charges repel*. This means a negative charge is drawn to a positive charge but pushes away from another negative charge. This is called *electrostatic force*.

Normally, the positively charged protons hold the negatively charged electrons in place. However, an electron sometimes breaks away from an atom because of an outside force, such as heat, light, magnetic fields, or chemical reactions.

Electrons have a negative charge. So if an object loses electrons, it becomes positively charged. If an object gains electrons, it then has a negative charge. A unit of electrical charge is called a *coulomb*.

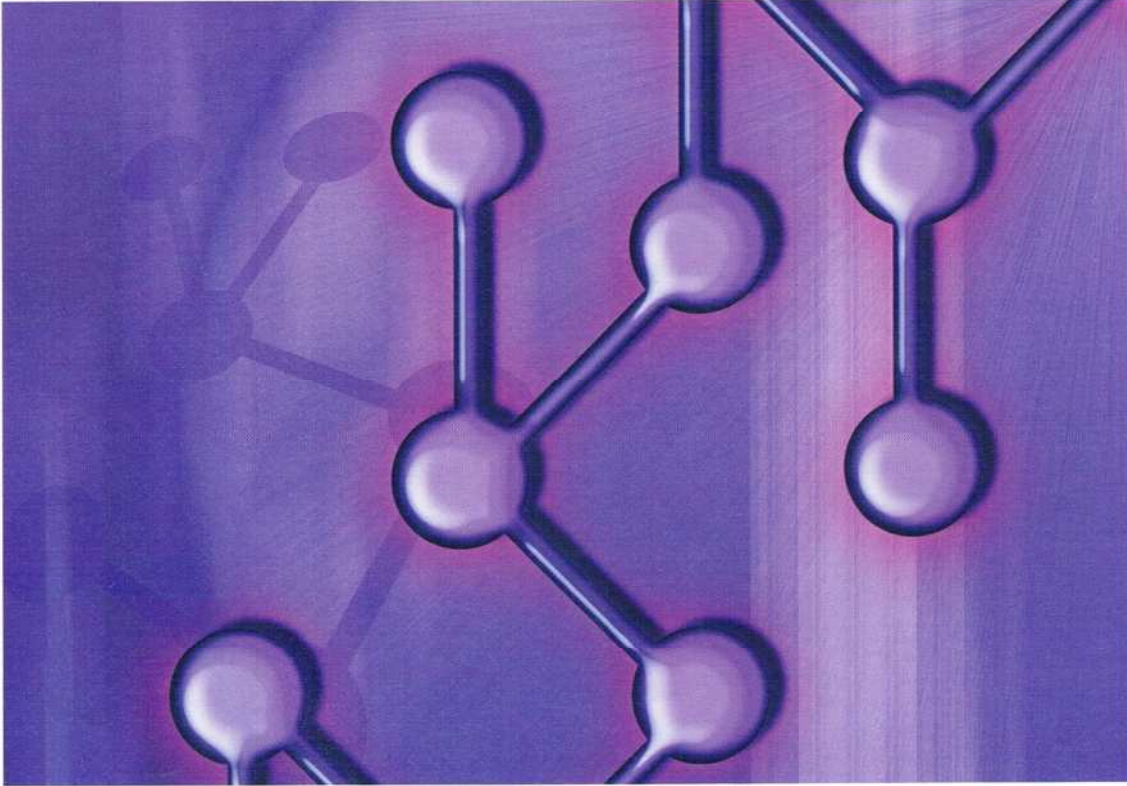

Once freed, electrons can “float” among atoms. These *free electrons* are what is important in electronics. Devices such as resistors, capacitors, and transistors are used to control the behavior of these free electrons.

Conductors and Insulators

Conductors act as a pathway for free electrons. Most metals are good conductors of electrons, so they can be used to “transport” electrons from one place to another. *Insulators* act as walls or barriers, preventing electrons from flowing where we do not want them to flow. Insulators, for example, are used on most electrical wires to protect us from electrical shock.

Copper, silver, and gold are popular conductors because they have a large number of free electrons. As an example of how to make the electrons flow, picture a length of copper wire with one end connected to the positive terminal of a battery and the other end connected to the negative terminal. The positive terminal attracts the negatively charged free electrons of the wire (remember: unlike charges attract) while at the same time the negative terminal repels the electrons. The result is a flow of electrons through the wire from the negative to the positive terminal. This flow is called an *electric current*.

An insulator works just the opposite. In some materials, such as plastics and glass, atoms hold their electrons tightly. These materials have very few free electrons. Therefore, if a length of insulator is connected to a battery the same way the copper wire was attached, no measurable current would flow.

Current, Voltage, and Resistance

Here are some basic definitions of terms used in electronics.

- *Current* is the orderly movement of electrons through a conductor. Current is measured in *amperes*, or *amps*, or the rate at which electrons move past a given point. One ampere is the movement of about 6 billion billion electrons past that point in one second.
- *Voltage* is an electrical pressure that can cause current to flow. Voltage forces current to flow through a wire in much the same way that water pressure forces water to flow through a pipe. This electrical pressure can be caused with magnetism, chemicals, friction, light, or heat. The unit of voltage is the *volt*.

A standard flashlight battery can produce 1.5 volts. A car battery produces about 12 volts. A light bulb in your home operates on 115 volts, while an electric stove requires about 220 volts. Your television might require 25,000 volts or more.

- The opposition to current flow is *resistance*. The resistance of a material is mainly determined by how many free electrons it has. If the material doesn't have many free electrons, it will have little or no current flow. The unit of resistance is the *ohm*. One ohm is the amount of resistance that will allow 1 ampere of current to flow when the applied voltage is 1 volt.

Know Your Units of Measure

- Electrical charge is measured in *coulombs*.
- Current is measured in *amperes*, or *amps*.
- Voltage is measured in *volts*.
- Resistance is measured in *ohms*.
- Electrical power is measured in *watts*.
- Capacitance is measured in *farads*.
- Frequency is measured in *hertz*.

Ohm's Law

Ohm's law describes the basic relationships between current, voltage, and resistance. The formula for Ohm's law is:

$$\text{Voltage (volts)} = \text{Current (amperes)} \times \text{Resistance (ohms)}$$

To determine current, the formula would be:

$$\text{Current (amperes)} = \text{Voltage (volts)} \div \text{Resistance (ohms)}$$

If you know current and resistance, you can find out the voltage. For example, how much voltage is needed to force 2 amperes of current to flow through 10 ohms of resistance?

Ohm's law tells us that we need to multiply our 2 amperes (current) by the 10 ohms (resistance) to arrive at the answer: 20 volts.

If you know voltage and resistance, you can figure out current (Voltage \div Resistance). Therefore, how much current will flow in a circuit having 5 ohms of resistance when 15 volts are applied?

$$15 \text{ volts} \div 5 \text{ ohms} = 3 \text{ amperes}$$

With these formulas, you can solve simple problems involving current, voltage, and resistance.

Power

Another electrical quantity is power. Power is the rate at which work is done. The unit of electrical power is the *watt* and can be compared to the unit of mechanical power, called *horsepower*. One horsepower is equal to 746 watts. The formula for power is

$$\text{Power (watts)} = \text{Voltage (volts)} \times \text{Current (amperes)}$$

When this formula is applied, you can determine the amount of power used by a circuit if you know the voltage and current. For example, how much power is used by a 120-volt toaster that draws 5 amperes?

$$120 \text{ volts} \times 5 \text{ amperes} = 600 \text{ watts}$$

The power used by the toaster is 600 watts. This power is used, or dissipated, in the form of heat to toast the bread.

James Watt, a Scottish engineer and inventor in the 18th and early 19th centuries, actually tested horses hauling coal to help him arrive at the determination that 1 horsepower is the amount of power required to lift 33,000 pounds 1 foot in 1 minute. The watt is named after him.

Resistance and Resistors

You have learned that when you apply a voltage to the ends of a conductor, it creates a current. Its strength depends on the applied voltage and the resistance of the conductor. The resistance of a conducting material depends on three factors:

1. The kind of material
 2. The length of the material
 3. The diameter or area of the material
- Temperature also is a factor in resistance. In most materials, resistance is increased when the temperature rises and decreased if the temperature is colder. In most simple circuits, however, temperature is not critical and is often ignored. The *kind of material* is probably the most important factor in resistance. Copper, for example, is a good conductor, while iron of a similar size has a higher resistance. Carbon has even a higher resistance than iron.

The *longer the conductor*, the higher the resistance will be. For instance, if the length of a copper wire is doubled, the resistance will be doubled. As an example, a 60-foot length of copper wire might have a resistance of 1 ohm. A same-sized copper wire that is 120 feet long would have a resistance of 2 ohms.

Size is important, too. A thick conductor will carry more current and offer less resistance than a thin one. Think again of water pipes. A large water pipe will allow more water to flow than a small one. When a current flows through a *resistor*, a component that limits or opposes the flow of a current, work is being done to move the electrons. This work produces heat and warms the resistor. Heat produced by an electric current is the basis for the operation of many electrical devices and appliances such as heaters, toasters, stoves, and soldering irons.

In a lightbulb, an electrical current causes a wire filament to become so hot that it glows to produce light. Only a fraction of a current is needed to produce the light, so a resistor is used to limit the current or to develop a voltage. A resistor is designed to have a specific value of resistance, and resistors are available in a wide range of values. Standard power sizes are $\frac{1}{4}$ watt, $\frac{1}{2}$ watt, 1 watt, and 2 watts. These values indicate the maximum recommended power that the resistor can dissipate. The higher the power rating, the larger the resistor.

Capacitors and Capacitance

A *capacitor* is a device that can store electrons, or an electrical charge, that can be released at a later time. Imagine two sheets of aluminum foil (conducting plates) that are separated by a sheet of waxed paper (an insulator). If you connect a battery to the two aluminum sheets, electrons will flow from the sheet that is connected to the positive terminal of the battery. Simultaneously, the same number of electrons will flow from the negative terminal of the battery to the other aluminum sheet. The number of electrons that are transferred makes the voltage between the aluminum sheets exactly that of the connected battery. If the battery is removed, the aluminum sheets will remain in their charged state. If there is no leakage through the waxed paper, the sheets will remain charged indefinitely.

Any two conducting plates separated by an insulator make up a capacitor. A capacitor can consist of many conducting plates with insulating separators. Alternate plates would be connected to form inter-leaved stacks.

The higher the voltage, the greater will be the amount of charge that is transferred from one plate to the other. The ratio of charge to voltage is defined as the *capacitance* of the capacitor. Or you could also say that the "electrical size" of a capacitor is its capacitance, which is the amount of electric charge it can hold. The unit of capacitance is the *farad*. However, this unit is too large for most practical capacitors, so capacitors are manufactured to measure millionths of a farad (microfarads) and trillionths of a farad (picofarads, which are micro-microfarads).

The insulators that separate conducting plates in a capacitor can be made of several materials, including ceramic materials, mica, certain types of paper, air, and oxide (a compound containing oxygen). A popular capacitor has been the electrolytic capacitor. In this capacitor, the insulator is an extremely thin oxide layer. The leads of electrolytic capacitors are marked positive and negative. These indicate how the capacitor must be connected for proper operation.

Electron Tubes

The electron tube made the science of electronics possible. Although it largely has been replaced by transistors, it still has special uses.

A **diode** allows current to flow through it in one direction but not the other. It has two main electrodes, placed a short distance apart in a vacuum. One electrode is called the *plate*, the other the *cathode*. A *filament* (or heater) heats the cathode. The cathode is made of a material that emits electrons when it is heated, so a cloud of electrons surrounds the heated cathode. When the plate of the diode is connected to the positive side of a battery, electrons from the cathode will flow to the plate. As we have learned, the positive charge attracts the negatively charged electrons. Therefore, electrons can easily flow from the cathode to the plate.

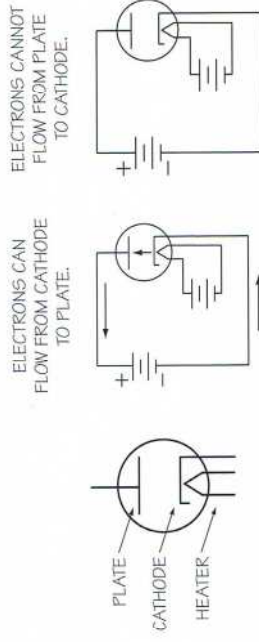

How the diode operates

The dictionary defines an *electrode* as a conductor that establishes electrical contact with a nonmetallic part of a circuit.

However, if the negative terminal of the battery is connected to the plate, no current will flow. That's because a negative voltage repels negative charges. So, a negative charge on the plate repels the electrons (which also are negative) that are emitted by the cathode. Furthermore, the plate cannot emit electrons of its own because it is not heated. Thus, no current can flow between the plate and the cathode.

See the Schematic Diagrams chapter to help you understand the illustrations in this section.

A **triode** is a three-element tube. A fine-mesh wire resides between the plate and the heated cathode. This extra element, the *control grid*, regulates the current that flows through the tube. When the grid is positive, it attracts the electrons emitted by the cathode. However, because the grid is a wire mesh, most of the electrons pass through the mesh and to the plate. If the grid is positive, a heavy current will flow from cathode to plate (see the illustration). If negative voltage is applied to the grid, it repels the electrons emitted by the cathode. Only a few electrons make it through the wire mesh and go to the plate. If the grid is made negative enough, no electrons will flow. Thus, the voltage on the grid determines the amount of current that flows through the tube.

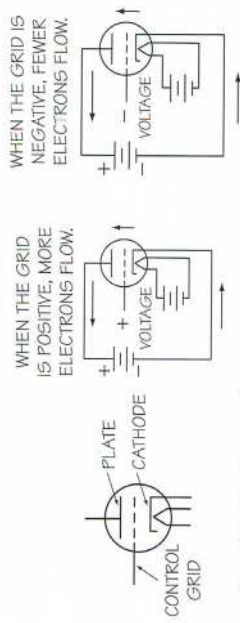

How the triode operates

As an example, the voltage applied to the grid might come from a microphone. The mike produces a low voltage that corresponds to the sound striking the grid on the mike. This causes the current through the tube to fluctuate with the sound. The fluctuating current in the speaker reproduces the sound. If the circuit is designed properly, the output sound produced by the speaker will be louder than the original sound.

Semiconductors

The word *semiconductor* is used to name a wide variety of electronic devices. Made of solid or liquid material, semiconductors generally are able to conduct electricity more easily than an insulator, but not as easily as a metal.

The **semiconductor diode** performs the same basic function as the electron-tube diode. It allows current to flow in one direction, but not the other. The diode consists of two different types of silicon crystals. An impurity (some type of substance) can be added to one area of the silicon to control the silicon's

conductivity. The silicon is said to have been "doped" when it has been treated with atoms from an impurity. These atoms combine with the silicon atoms in such a way that electrons float around freely inside the silicon. This type of silicon is called *N-type* (or negative-type). The N-type silicon is the cathode of the diode.

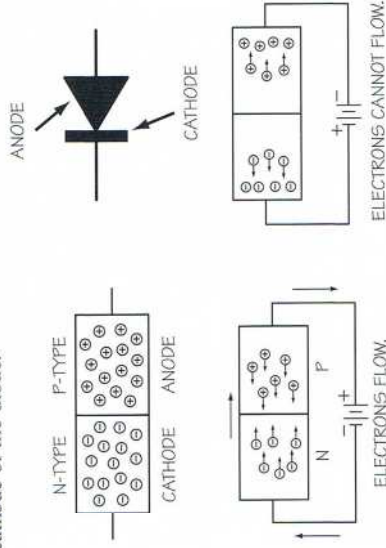

Semiconductor diode

The other area of silicon also has an added impurity. But the atoms of this impurity combine with the silicon atoms in such a way that there is a shortage of one electron in the bonding. The absence of an electron is called a "hole," and this hole can grab an electron from a neighboring atom. Thus, a hole can "float" from atom to atom the same way an electron might. The silicon with the holes is called *P-type* (positive).

For current to flow through the diode, the negative terminal of the battery must connect to the N-type silicon (the cathode) and the positive terminal to the P-type silicon (the anode). The negative terminal repels the free electrons of the N-type material. The electrons are forced toward the junction where they fill the waiting holes. However, as the electrons leave the anode, new holes form. This results in a constant flow of current from cathode to anode.

Current cannot flow in the opposite direction (see the illustration for the semiconductor diode). If the battery's connection is turned around, it attracts the electrons and the holes away from the junction. Because there are no free electrons at the junction, no current can flow.

The **transistor** is perhaps the most important invention in the history of electronics so far. A transistor uses the P-type and N-type silicon in much the same way as a diode. However, the transistor has three electrodes, called the *emitter*, the *base*, and the *collector*. The collector is connected to the positive terminal of the battery, and the emitter is connected to the negative terminal. Electrons will try to flow from the emitter to the collector. However, a thin layer (the base) separates these two elements. If the base is negative, it repels the free electrons in the emitter. In this case, no current can flow from the emitter to the collector.

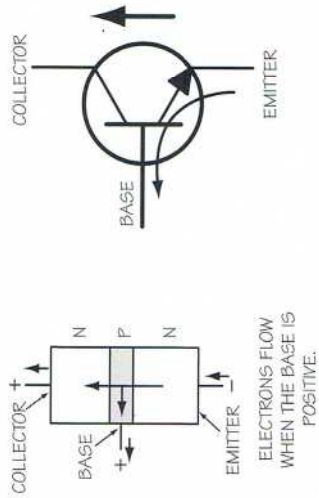

NPN transistor

If the base is positive, electrons can flow into the base from the emitter. Some of the electrons will flow into the positive base lead. But because the base is very thin, most of the electrons travel through the base to the collector. Thus, if the base is made more positive, more electrons will flow. Conversely, making the base less positive will reduce the current flow. You can see then that a small voltage on the base will control the amount of current through the transistor. For this reason, the transistor can be used as an amplifier in much the same way as a vacuum tube.

Notice the symbol in the illustration used to represent the NPN transistor. Another type of transistor is called the PNP transistor. Its structure and schematic symbol are shown in the illustration. This transistor requires opposite polarity voltages for proper operation.

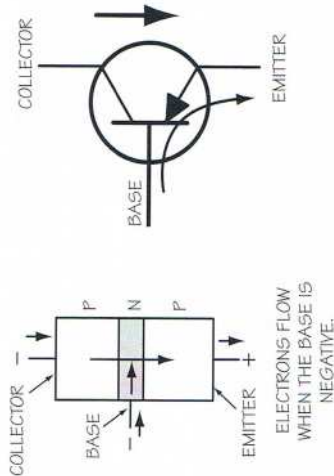

PNP transistor

NPN and PNP transistors are called *bipolar transistors*, and they are the most popular types used. A number of other semiconductor devices are loosely called transistors, such as field effect transistors, unijunction transistors, and silicon-controlled rectifiers, but these won't be discussed in this pamphlet.

Integrated Circuits

An *integrated circuit* (IC) is a complete circuit in a single package. Transistors, resistors, diodes, and capacitors can be formed in a single chip of silicon, a semiconductor. One chip can contain thousands or even millions of electronic components. Integrated circuits have revolutionized many fields, including



The **integrated circuit, or IC, has led to smaller electronic devices that are faster and more reliable.**

communications, information handling, and computing. They have reduced the size of devices, while providing faster speeds and increased reliability. The individual components of ICs are extremely small and are assembled to a pattern that has

been planned in advance. A chip might look flat, but it has several layers for circuits. Switches control the electrical current through the chip. The switches manipulate the binary code (discussed below) with "on" and "off" switches. The binary code is at the core of how a computer operates. Chips come in many different sizes, with millions of transistors being able to fit on chips the size of a postage stamp.

Two basic types of IC are called *linear* and *digital*. Linear circuits include amplifiers, oscillators, regulators, and other circuits used in TV sets, audio amplifiers, radios, and hearing aids. Digital circuits include memories and arithmetic circuits and counters in watches, calculators, computers, and video games.

Microprocessors

The microprocessor is a type of ultra-large IC. By 1971, the technique of making ICs had progressed to the point where enough computing power could be put on a single IC to form a tiny, primitive computer, or calculator. The first microprocessor was born. Today, microprocessors can incorporate as many as 10 million transistors, plus components such as resistors, capacitors, diodes, and wires.

The microprocessor accepts input data, modifies that data in some way, and produces an appropriate output. The earliest application of the microprocessor was the calculator. A calculator accepts numbers that the user enters on a keyboard, performs a mathematical operation on those numbers that the user desires, and then sends the result to a display. Today's microprocessors function as the central processing unit (CPU) of computers. They also are used in many electronics systems such as cameras, printers, planes, and automobiles.

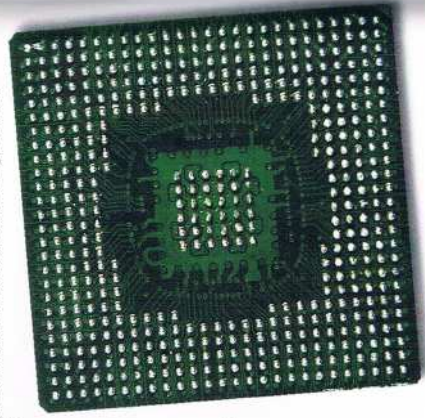

The microprocessor in an automobile, for instance, examines inputs from several sensors, makes decisions based on those inputs, and adjusts such things as the mixture of air and fuel and the timing of ignition firing. The microprocessor's most important aspect is that it can be programmed to perform an almost limitless number of applications.



Schematic Diagrams

The illustrations in the previous section didn't show you a picture of a real diode or transistor. Instead, they showed you a kind of illustrated outline, call a *schematic diagram*. These diagrams are a simple way of showing how electronic components are connected. In a schematic, symbols stand for the different electronic components. The schematic diagram illustrated here is for a

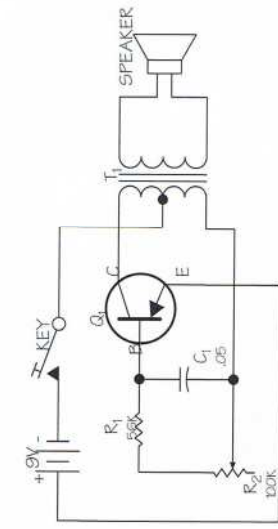

Schematic diagram, code-practice oscillator

code-practice oscillator. The corresponding pictorial representation shows how the components actually look. In the schematic, a different type of symbol represents each type of component: long and short lines represent the battery; a zigzag line stands for a resistor. In this section, you will learn these symbols so that you can understand schematic diagrams.

To start, compare the schematic diagram of the oscillator with the pictorial and match each symbol in the schematic with its equivalent component in the pictorial. Also match each line in the schematic with the

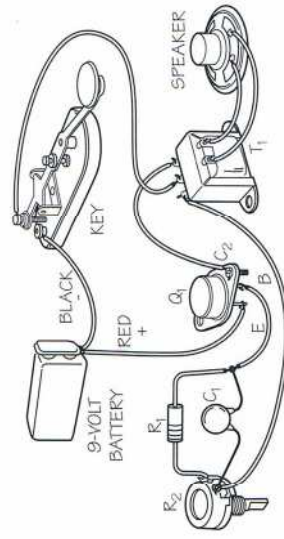

Pictorial representation, code-practice oscillator

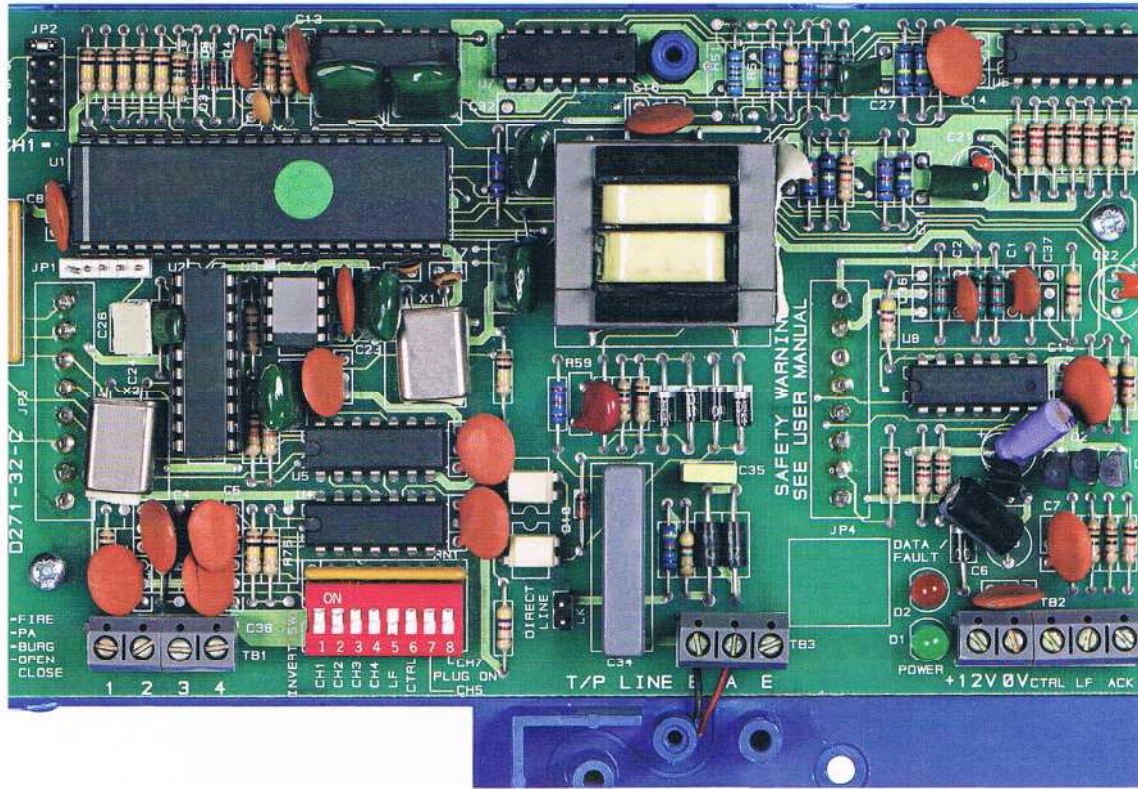

appropriate wire in the pictorial. Notice where two lines cross in the schematic. If the wires are to be connected, a dot shows at the crossing on the schematic. If there is no dot, the two wires bypass each other and are not connected.

When you draw your schematic for requirement 2, you will need a sharp pencil, paper, and a ruler or straight edge for drawing straight lines. A compass might be helpful for drawing circles. If you have a computer with a drawing program, you might use that to draw a schematic.

Components

Before we look at the most common types of electronics components, as well as the schematic symbol and a pictorial of each one, let's define and review some basic terms (also see the Basic Electronics Theory section above):

- *Electricity* is a property that electrons have that causes them to behave in certain predictable ways.
- *Electrical charge* is a quantity of electricity.
- The *electron* is a tiny particle that has a negative electrical charge.
- *Current* is defined as the flow of electrons.
- *Voltage* is the pressure that causes current to flow.
- *Resistance* is the opposition to current flow.
- *Direct current* (DC) is current that always flows in the same direction.
- *Alternating current* (AC) is a current that reverses its direction of flow many times each second.

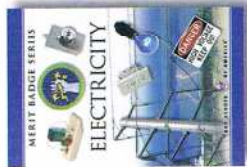

To learn more, read the *Electricity* merit badge pamphlet.

Know Your Prefixes

- The prefix *kilo* (k) designates 1,000. The term kilovolt, then, means 1,000 volts.
- The prefix *mega* (M) is used as a prefix to designate 1 million. The term megawatt means 1 million watts.
- The prefix *micro* (μ) is a prefix that means one-millionth. Thus, a microsecond is one-millionth of a second.

Each **resistor** has a specific amount of resistance. A resistor is somewhat comparable to a nozzle on a water hose. For a given water pressure, the nozzle controls the amount of water that is allowed out of the hose. Similarly, for a given voltage, a resistor controls the flow of electrical current.

Most resistors are made of a carbon compound. Resistors used for high currents often are made from special wire that is wound on an insulating form. The type of compound or wire used determines how much electrical current can flow for a given voltage.

The value of a resistor is given in ohms. The symbol for the ohm is the Greek capital letter omega (Ω). Thus, 1Ω designates the resistance of 1 ohm. A $1k\Omega$ resistor has a resistance of 1 kilohm, or 1,000 ohms. A $1M\Omega$ resistor has a resistance of 1 megohm, or 1 million ohms.

The illustration here shows a variety of *fixed resistors* and a *cross-section* of a fixed resistor:

The values of fixed resistors cannot be changed.

The resistance of *variable resistors*, however, such as those shown, can be changed. Variable resistors have a slider that can be moved with a

knob or adjusted with a screwdriver. Rheostats and potentiometers are types of variable resistors. These resistors can be used in appliances that need their currents adjusted or when the resistance needs to be varied, such as with lights that can be dimmed.

Fixed resistors

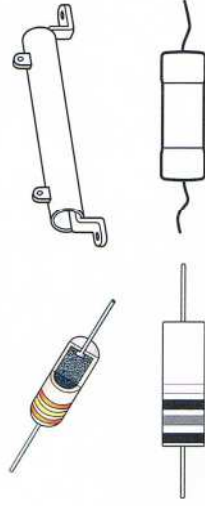

Resistors have bands of color that allow you to determine their mathematical value. The cross-section of this fixed resistor shows the inside, which is made of carbon. Note the schematic symbol for a fixed resistor.



Schematic symbols, fixed resistor

Many kinds of **coils**, or inductors, are used in electronics. When a current flows through them, energy is stored in the magnetic fields they produce. Using a coil with a capacitor results in a tuned circuit that has a natural frequency. This type of circuit is often connected to the antenna of a radio receiver. It tunes one station at a time, ignoring all the stations of frequencies to which it is not tuned. A *choke* is a particular type of coil that blocks the passage of alternating current (AC) but permits the passage of direct current (DC).

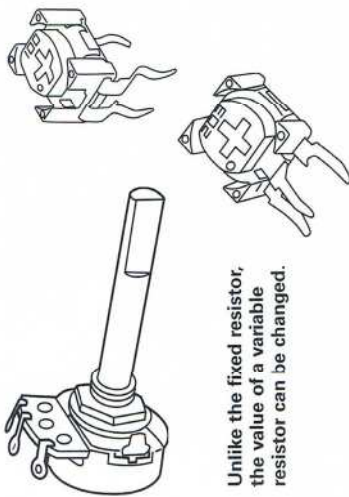

Unlike the fixed resistor, the value of a variable resistor can be changed.

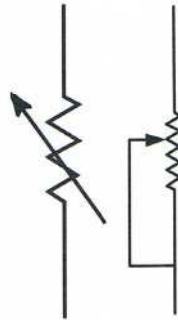

Schematic symbols for the variable resistor



Coils



Schematic symbols for coils

A **capacitor** is a storage element for electrical charge, similar to a bottle that stores a liquid. The basic unit of capacitance is the farad (F). Practical capacitors have capacitance values in microfarads (μF). The physical size of a capacitor depends on its voltage rating and its capacitance value. The higher the voltage rating and the larger the capacitance value, the larger the capacitor must be.

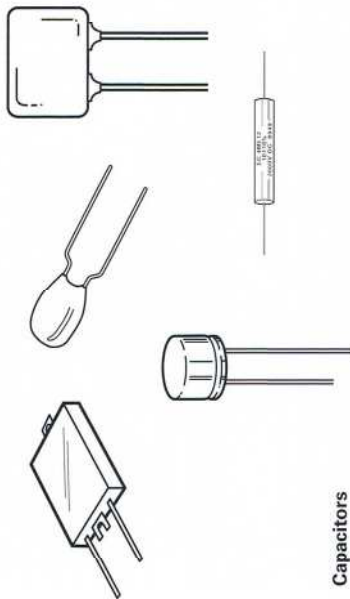

Capacitors

As you have already seen, there are dozens of types of **semiconductor devices**, including the transistor and the diode. Transistors are solid-state devices used for controlling current. A very small input current controls a much larger output current. For example, the small current from a microphone can control a much larger current that drives a loudspeaker. This is the idea behind the audio amplifiers used in public address systems.



Schematic symbol, fixed capacitor

Schematic symbol, variable capacitor



NPN transistor, schematic symbol



PNP transistor, schematic symbol

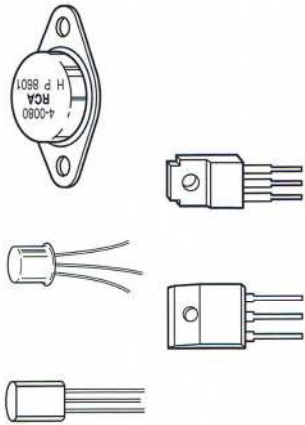

Transistors

Diodes operate as check valves, passing current in one direction but not the other. A diode's most common application is in power supplies. It changes alternating current (AC) into direct current (DC).



Schematic symbol

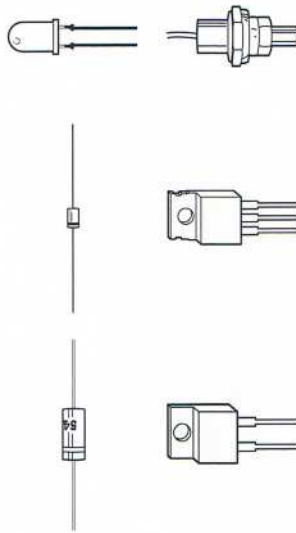

Diodes

The operation of an **electron tube** is somewhat similar to that of a transistor. In the tube, a small input voltage controls a relatively high output voltage. Thus, a tube can amplify a signal in much the same way a transistor does. Today, most electron tubes have been replaced by solid-state devices, such as transistors. However, for uses that require high power, tubes are still used. The most popular is the picture tube in many television sets.

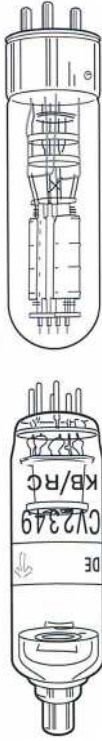

Electron tubes

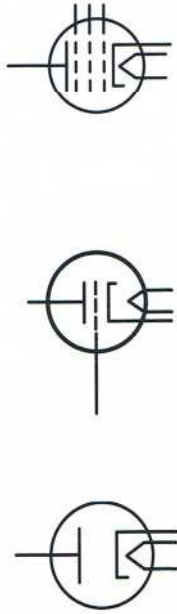

Schematic symbols

Complex circuits are available in integrated circuit (IC) form at inexpensive prices. The IC, which consumes little power, is reliable, cheap, and small. Because devices using ICs can be improved and made cheaper, the IC has replaced traditional components in many applications. As shown here, ICs come in several types of packages. The *axial in-line package (DIP)* is the most popular style for most applications.

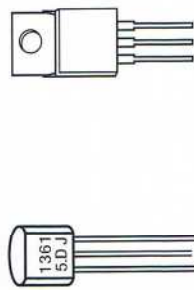

Integrated circuits

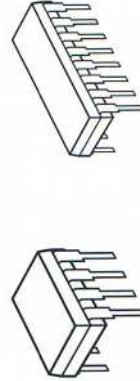

DIPs

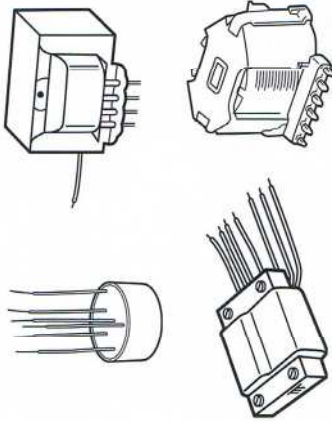

Transformers

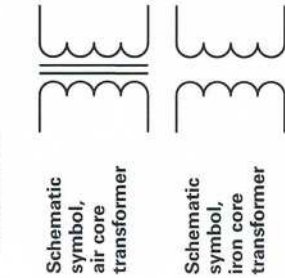

Schematic symbol, air core transformer

Schematic symbol, iron core transformer

The main purpose of a **transformer** is to step up or step down voltages or currents. For example, a step-up transformer can change low-voltage, high-current electricity into high-voltage, low-current electricity. A transformer is often used as a go-between that links two circuits that have different characteristics.

To record or broadcast music and speech, we first use a **microphone** to change sounds into electrical impulses. A **speaker** then converts the electrical impulses back into sounds. A thin, flexible disk, or *diaphragm*, in the mike vibrates whenever sound strikes it. This causes a current to vary at the same rate as the sound that hits the diaphragm. At the other end, the varying current produces a changing magnetic field in the speaker. This causes a diaphragm to vibrate, re-creating the original sound.



Microphones

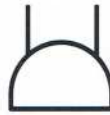

Schematic symbol, microphone

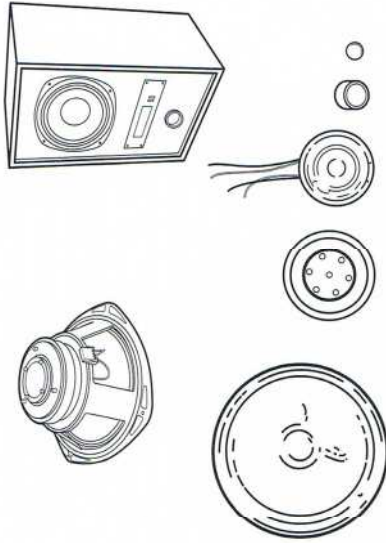

Speakers

Transistor circuits operate at low supply voltages and have low power requirements. Therefore, transistor devices are often driven from small **batteries**. Depending on the type of transistor used, two to four flashlight batteries are often adequate for relatively long service. Ordinary flashlight dry cells produce approximately 1.5 volts. Four 1.5-volt cells connected in a series can provide 6 volts. Single 9-volt batteries also are used.

Batteries are made from several types of materials for different uses. Alkaline, lithium, and mercury batteries are used when long life is desired. Nickel-cadmium batteries give shorter service but can be recharged. The nickel-metal hydride battery is replacing the nickel-cadmium battery because it doesn't suffer the memory effect (that is, not allowing a partially charged battery to fully recharge before use). Zinc-carbon also is used in many inexpensive dry-cell batteries.

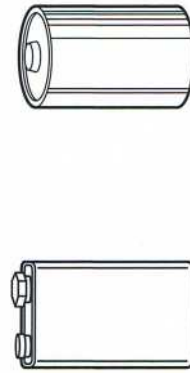

Batteries

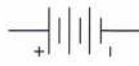

MULTIPLE-CELL BATTERY

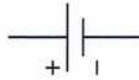

SINGLE-CELL BATTERY

Schematic symbols

Switches are an important part of almost all electronic equipment. They come in a wide variety of shapes, sizes, and functions. The simplest is the *single-pole, single-throw* type. When closed, this switch completes a circuit, allowing an electric current to flow. When open, the circuit is broken and the current does not flow. The on-off switches on most electronic devices are of this type. A *single-pole, double-throw* switch has a contact arm that can be set in either of two positions. In the example shown in here, terminal A can be connected to either terminal B or terminal C. A *double-pole, double-throw* switch can simultaneously switch two wires from one circuit to another. It can be thought of as two single-pole, double-throw switches that operate together. A *rotary or selector* switch has one or more arms that can be set to various positions.

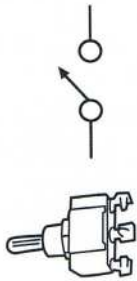

SINGLE-POLE, SINGLE-THROW

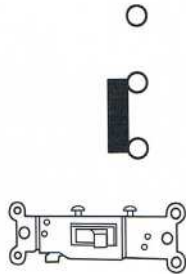

SINGLE-POLE, DOUBLE-THROW

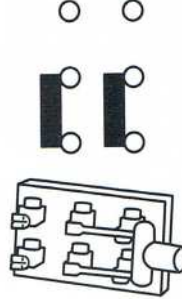

DOUBLE-POLE, DOUBLE-THROW

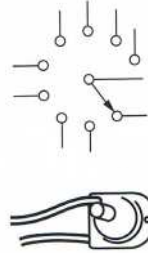

SELECTOR SWITCH

Switches and their schematic symbols

resistor (LDR). This special resistor has a small window so that light can strike the resistance material. Generally, such a cell has a high resistance when in darkness. Another type is called a *photo voltaic cell*. This is the familiar "solar cell" that is used to power electronic equipment on spacecraft. It produces a low voltage across its terminals when exposed to light, especially sunlight, thus converting light energy into electrical energy.

PHOTOCONDUCTIVE CELL



PHOTOVOLTAIC OR SOLAR CELL

Photoelectric cells

A **relay** can be thought of as a magnetically operated switch with many turns of wire on an iron core. When current flows through the coil, a magnetic field develops. The magnetic field attracts a movable part called an *armature*, which closes one or more switch contacts. A relatively small current can cause the switch contacts to close, but the contacts can handle a much heavier current. The relay allows a small current to switch a higher current on or off. By using several switch contacts, a relay allows a single current to control several different currents simultaneously.

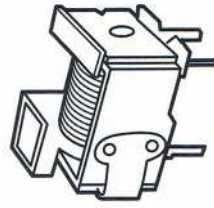

Relay

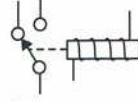

Schematic symbol, relay

Schematic symbols, photoelectric cells



The Color Code of Resistors

The *value* of a resistor is specified in ohms and is indicated by colored bands around one end of the resistor. The electronics industry devised this system because small printed numbers would be too hard to read or might be concealed by the position of the resistor.

Most resistors have four bands, with the first three (counting from the end of the resistor) indicating the value in ohms. The fourth, which is either silver or gold, indicates the tolerance (discussed below). Colors used for the bands are used in place of numbers. To determine the resistance value in ohms, examine the color bands starting with the one closest to the end of the resistor.

The development of electronics has benefited our daily lives in many ways, including the protection of life and property. Today, electronics and electronic circuits play a vital role in the security field. Whether it's a burglar alarm motion sensor, door contact, or the alarm panel and communication devices, closed circuit television (CCTV), or devices related to detecting smoke and fire, electronics is what makes it all happen.

A **photoelectrical cell** changes one or more of its characteristics when exposed to light. It is popularly called the *electric eye*, which controls operations such as traffic lights, door openers, and devices that activate lights at dusk and turn them off at dawn. One type of photoelectric cell is called a *photoconductive cell*. Another name for this type of cell is the light-dependent

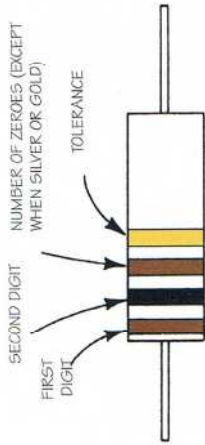

Resistors are labeled with colored bands. The colors of the bands represent numbers that determine a resistor's value. The fourth band represents the resistor's tolerance.

The fourth band indicates the *tolerance* of the resistor, which tells how accurate the actual value is. If the fourth band is silver, the tolerance is ± 10 percent; if it is gold, the tolerance is ± 5 percent. This means that the actual value of the resistor is guaranteed to be within 10 percent or 5 percent of its value. If a resistor lacks a fourth band, you can assume that the tolerance is ± 20 percent.

Suppose a resistor has a brown, a black, and then a brown band. The code chart shown here tells you that brown represents the number 1. The second black band represents the number 0. The third band tells you how many zeroes to add to the first two numbers. In the example, the band is brown, so you add one zero. Therefore, the value of this resistor is 1-0-0, or 100 ohms.

Now try the example for the resistor shown here, which has a red band first, then a yellow band, and then an orange band. The red band means that the first number is 2. The yellow band corresponds to the number 4. The orange band tells us to add three zeroes. Thus, the value is 2-4-000, which translates to 24,000 ohms, or 24 kilohms (k Ω).

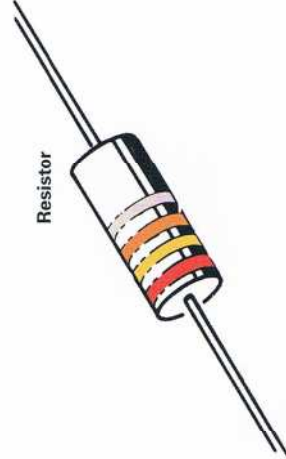

Resistors in an old radio

If you need help remembering the order of the colors in this chart, you can memorize this simple sentence, in which each word begins with the same letter as the color: "*Better Be Right Or Your Great Big Venture Goes West.*"

Color	First Band	Second Band	Third Band*
Black	0	0	0
Brown	1	1	00
Red	2	2	000
Orange	3	3	0,000
Yellow	4	4	00,000
Green	5	5	000,000
Blue	6	6	0,000,000
Violet	7	7	00,000,000
Gray	8	8	000,000,000
White	9	9	0,000,000,000

*Add this many zeroes after the first two numbers.

Soldering

Before you begin working with a circuit, read and study this chapter on soldering. Anyone working in electronics must know how to solder well, and safely. It takes practice, but once you learn, you will be able to properly assemble an electronics project.

Review the “Soldering Safety” tips in chapter 1 before you begin your soldering work on requirement 3.

In all electronics work, the wiring connections must be absolutely secure. A loose connection in a radio, for example, could result in noise, scratching sounds, or no sounds at all. Poor connections in a TV could disrupt the sound and picture. And beyond just a radio and a TV in someone’s home, the safe operation of airplanes and the lives of astronauts in flight depend on secure electronics connections.

Soldering is not just gluing metals together like you glue together pieces of wood. Done correctly, soldering unites the metals so that electrically they act as one piece of metal. You do this with a mixture of lead and tin solder and a soldering iron.



Soldering Safety Tips



- Solder only under the constant supervision of a responsible and knowledgeable adult.
- Certain kinds of solder release fumes that can be harmful to your eyes and lungs; therefore, always work with solder in a well-ventilated area.
- Do not allow anyone to drink, eat, or smoke in the soldering area.
- Wear safety goggles when soldering.
- Before you start soldering, protect any flammable material with a fireproof shield or wet rags, and have a fire extinguisher nearby.
- Be careful not to let hot solder splash around because it will burn you almost instantly.
- If possible, use a soldering iron stand or clamps when you are soldering, leaving one hand free to hold the solder.
- Don't overheat components, circuit boards, or plastic wires when soldering.
- *Oxidation* (rust) develops more rapidly when a soldering iron is hot, so try to make sure the iron doesn't stay hot for long periods of time.
- Never touch the tip of a hot soldering iron; keep the iron in a holder when you aren't using it. Don't lay it down on your bench or work area.
- Never leave a soldering iron on unattended.
- When you are finished soldering and cleaning up, thoroughly wash your hands.

The Soldering Iron

An inexpensive pencil-type soldering iron of no more than 40-watt capacity (15 to 25 watts are also suitable) is the best for electronics work. The tip should be 1 to 2 millimeters (mm), and the solder should be 1 mm. It is helpful to get an iron with interchangeable tips of different diameters or shapes to be used on different kinds of work. The iron should be well-balanced and have a handle that will remain cool while you work.

Tinning your iron means coating the tip of the solder iron with a thin coat of solder. If your iron is new, read the instructions about preparing it for use. Most new irons are already tinned, so you might not have to tin it. If the tips are silvery, you can use them as they are.

If instructions aren't included with your iron and the tip is not silvery, first use a fine file to file the tip until it is shiny. Then heat the iron and coat the tip with rosin-core solder. Be sure to coat all sides of the tip.

If you have an older iron that has been used and the point is already silver-looking, just wipe it clean with a cloth and you are ready for work. If it is dull or looks coppery, file and tin it.

You also should have a heat-resistant bench-type iron holder so that the hot iron can safely be set down between uses. Look for one that has a holder for tip-cleaning sponges.

How to Solder

A well-soldered joint, one that will be reliable in use, will be nice and shiny looking. To achieve a well-soldered joint, make sure you do the following:

1. Solder with a clean, well-tinned tip. Wipe the tip on a damp sponge before soldering and between soldering.
2. Make sure all wires, parts, and the circuit board to be soldered are clean.
3. Make a good mechanical joint before soldering.
4. Allow the joint to get hot enough before applying solder, and then apply an adequate amount of solder to the joint.
5. Allow the solder to set before handling or moving soldered parts.

If you take the time and make the effort to solder a perfect joint, you might save a lot of time later in trying to troubleshoot problems with your circuit.

Remember that in **preparing work for soldering**, dirt is the enemy of soldering. A solder will not take if parts are dirty, so be sure to completely clean all wires and surfaces before applying solder. Use fine sandpaper or emery paper to clean flat surfaces or wire. If you do have dirty parts or a dirty surface, you might try to use too much heat to force a connection.

Remember that no amount of cleaning will allow you to solder to aluminum. When making a connection to a sheet of aluminum, you must connect the wire by a solder lug or a screw.

When preparing wires, remove the insulation with wire strippers or a hobby knife. If using a knife, hold the knife at an angle as if you were sharpening a pencil. Do not cut straight into the insulation because you could nick the wire and weaken it. For enameled wire, use the back of the knife blade to scrape the wire until it is clean and bright.

Next, tin the clean end of the wire. Hold the heated tip of the soldering iron against the undersurface of the wire, and place the end of the rosin-core solder against the upper surface. As the solder melts, it will flow on to the clean end of the wire. Hold the hot tip of the iron against the under surface of the tinned wire and remove the excess solder by letting it flow down the tip. When properly tinned, the exposed surface of the wire should be covered with a thin, even coating of solder.

Before you begin, secure your work so that it won't move during soldering. With circuit boards, you could use holding frames. Use a modeler's small vice to hold other parts.

Unless you are creating a temporary joint, the next step is to **make a good mechanical connection** between the parts to be soldered. For instance, wrap the wire carefully and tightly around a soldering terminal or soldering lug. (Bend wire and make connections using long-nosed pliers.) When connecting two wires, make a tight splice before soldering. Once you have made a good mechanical contact, you are ready to solder.

When you are working with an ordinary circuit board, you will bend the wires of a component through the board. For those parts, such as some resistors, that become hot when in operation, raise them slightly above the board to allow some air circulation.

The next step is to apply the soldering iron and **solder to the connection**. The temperature of all the parts that are being soldered should be raised to about the same degree before applying the solder. If soldering a spliced wire, hold the iron below the splice and apply solder to the top of the splice. If the tip of the iron has a bit of melted solder on the side held against the splice, heat is transferred more readily to the splice, and the soldering can be done more easily. Don't try to solder by applying solder to the joint and then pressing down on it with the iron.

It usually takes two to three seconds to solder on a printed circuit board. Remember: Too much solder on a joint might cause short circuits with adjacent joints. However, if you don't apply enough solder, you might not form a secure and fully working joint.

When soldering the wires of a component, you might snip the extra wire leads off before soldering. However, with some components, such as semiconductors, it might be best to snip the surplus wire after you have made the joint.

Don't disturb the soldered joint until the solder has set. This might take several seconds, depending on the amount of solder used to make the joint. Then take a good look at the joint. It should have a shiny, smooth appearance. It should not be pitted or grainy. If it is, then reheat the joint, scrape off the solder, clean the connection, and start over.

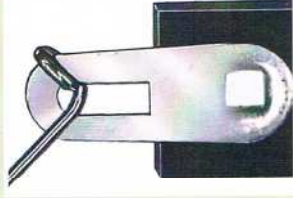

Attach the wire to a soldering terminal or soldering lug.

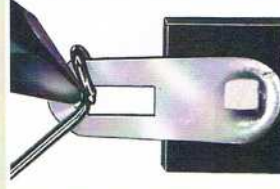

Heat the wire and the lug.

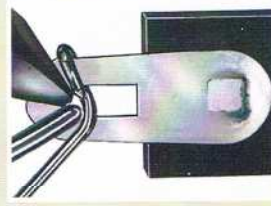

Apply solder to both the tip and the connection.

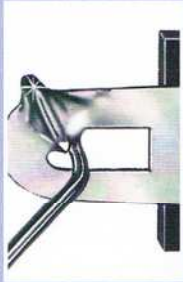

Let the connection harden before moving the wire. Check for a smooth, bright joint.



Poor connections look crystalline and grainy, or the solder tends to blob.



After the solder is well set, pull slightly on the wire to see whether it is a good, tight connection.

How to Desolder

In case you accidentally make a wrong connection or have to move a component that has been placed incorrectly, you should learn how to desolder connections. Take care when desoldering to avoid breaking or destroying good parts. The leads on components such as resistors or transistors and the lugs on other parts might sometimes break off when desoldering a good, tight joint. To avoid heat damage, use as much care in desoldering delicate parts as you do in soldering them.

There are two ways to desolder. The first and usually easiest way is to use a metal wick or braid on a small dispenser reel to remove the melted solder. This braid is available at most electronics parts stores. Place the braid against the joint that you want to desolder. Use your heated soldering iron to gently press the braid against the joint. As the solder melts, it is pulled into the braid. Don't let the joint cool while the braid is resting against the joint. By repeating this process, you can remove virtually all the solder from the joint. Then reheat the joint and lift off the component leads.

The second method involves using a desoldering pump, or a vacuum device, to suck up the molten solder. Most electronics parts stores have these devices. Follow the manufacturer's instructions for the pump you are using, but here are some general guidelines. Use your soldering iron to heat the joint that you want to desolder until the



Desoldering braid

solder melts. Then squeeze the desoldering pump to create a vacuum inside. Touch the tip of the pump to carefully “vacuum” the solder you want to remove. Repeat the process until you have removed most of the molten solder. Then reheat the joint and gently pry off the wires.

Experiment with and practice your soldering techniques before you begin working on your circuit to fulfill requirement 3. Use pieces of wire or some old components and wire. Practice until you can solder joints that are smooth, shiny, and tight. Then practice desoldering some of the connections until you are satisfied that you can do them quickly and without breaking wires or lugs.



Remember these things when desoldering:

- Be sure there is a little melted solder on the tip of your iron so that the joint will heat quickly.
- Work quickly and carefully to avoid damaging parts with heat. Use long-nosed pliers to hold the leads of components just as you did while soldering.
- When loosening a wire head, be careful not to bend the lug or tie point to which it is attached.

It's important to responsibly dispose of solder waste, which should be either recycled or treated as hazardous waste because it contains lead. It cannot be disposed of in your regular trash collection bin. As you desolder, collect the waste in a container clearly marked as solder waste—including the solder from your sponge or work towel. Throw your sponge or towel away. Contact local authorities for information about the proper disposal of solder waste in your area.



If you happen to get burned while soldering,

- Quickly cool the burned area with cold running water, an ice pack, or something frozen (such as a bag of peas) until the pain is gone.
- Apply a sterile dressing to help protect against infection.
- Do not apply any ointments or lotions.
- Seek medical advice from your doctor if the burn is severe.

Soldering Printed Circuit Boards

Most electronic devices use one or more printed circuit (PC) boards. A PC board is made of a nonconducting material, such as a thin sheet of fiberglass or phenolic resin (plastic) that has a pattern of foil conductors "printed" on it and has predrilled holes designed to hold components. You insert component leads into the holes and solder the leads to the foil pattern. This method of assembly is widely used, and you probably will use it if you choose to work with an electronics kit.

Printed circuit boards make assembly easier. First, insert component leads through the correct holes in the board. Mount the parts tightly against the circuit board unless otherwise directed. Insert a lead and then bend it slightly outward to hold the part in place. Then follow these steps.

Step 1—Touch the tip of your soldering iron to both the component lead and the foil until they are uniformly hot enough to melt the solder.

Step 2—Apply a small amount of solder to both the tip and the connection.

Step 3—Remove the iron and let the solder set before moving the wire or the board. The finished connection, as you have learned, should be smooth and shiny.

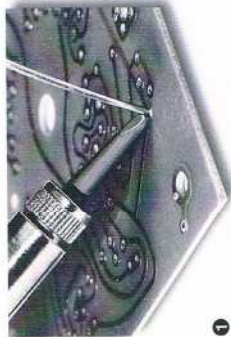

1

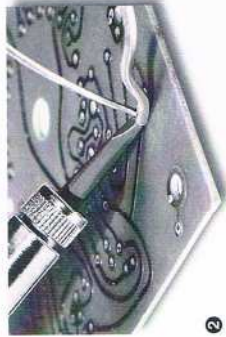

2



3

Step 4—Finally, clip off the excess wire length.

Occasionally a solder "bridge" will form when solder connects between two adjacent foil conductors. You must remove such bridges or a short circuit will exist between the two conductors and the circuit won't function properly. Remove the bridge by heating it with your soldering iron and quickly wiping away the melted solder with a soft cloth.



Be sure to remove all solder "bridges," which can cause short circuits.



A hole on the board could get plugged by solder. Clear the hole by heating the solder while pushing a component lead through the hole from the other side of the board.

Caring for Your Soldering Iron

- Keep your soldering iron cleaned and well-tinned.
- Keep a damp cloth or sponge on your workbench. Before soldering a connection, wipe the tip of the iron across the damp cloth or sponge and then touch some fresh solder to the tip.
- The tip eventually will become worn or pitted. Repair minor wear by filing the tip back into shape. Be sure to tin the tip immediately after filing it. If the tip is badly worn or pitted, replace it.
- Oxidation forms on the tip rapidly when the iron is hot, so don't keep the iron heated for long periods when you aren't using it.
- Don't try cooling the iron rapidly with ice or water. This could damage the heating element, and water might get into the barrel and cause rust.

Control Devices

An important application of electronics is the control of certain operations with the use of *control devices*. For example, control devices can make lights go on at certain times or open doors automatically. To satisfy requirement 4, you will build a working electronic circuit. You may choose to build a control device.

Allow several days to find and buy the necessary parts before you start building your circuit. See the resources section in the back of this pamphlet for information about suppliers.

Building a Control Device From Scratch

You can build a control project from a kit, but you may want to build a project from scratch. The one shown is easy to build and fun to use. It is a control circuit that uses light to control an audible alarm. This is a popular type of control circuit. It could be used in industry to warn if a flame in a furnace has gone out.

The circuit is constructed on the single piece of 3-by-4-inch perforated board. While the exact size is not critical, a board that is too big is better than one that is too small. The holes in the board need to be $1/10$ inch apart. This is necessary so that the pins of the op amp will fit.

Many types of boards are available. The board used (and shown in the photographs) for this project has foil patterns designed especially for integrated circuits, which makes the project easier. To use this type of board, insert components through the board from the top and solder to the foil patterns on the bottom of the board. You make connections from one component to the next by using short wires called *jumper*s.

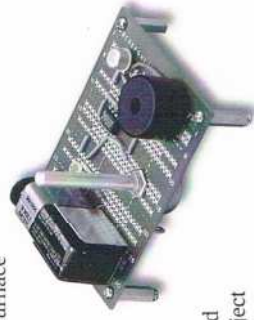

This control circuit uses light to control an alarm.

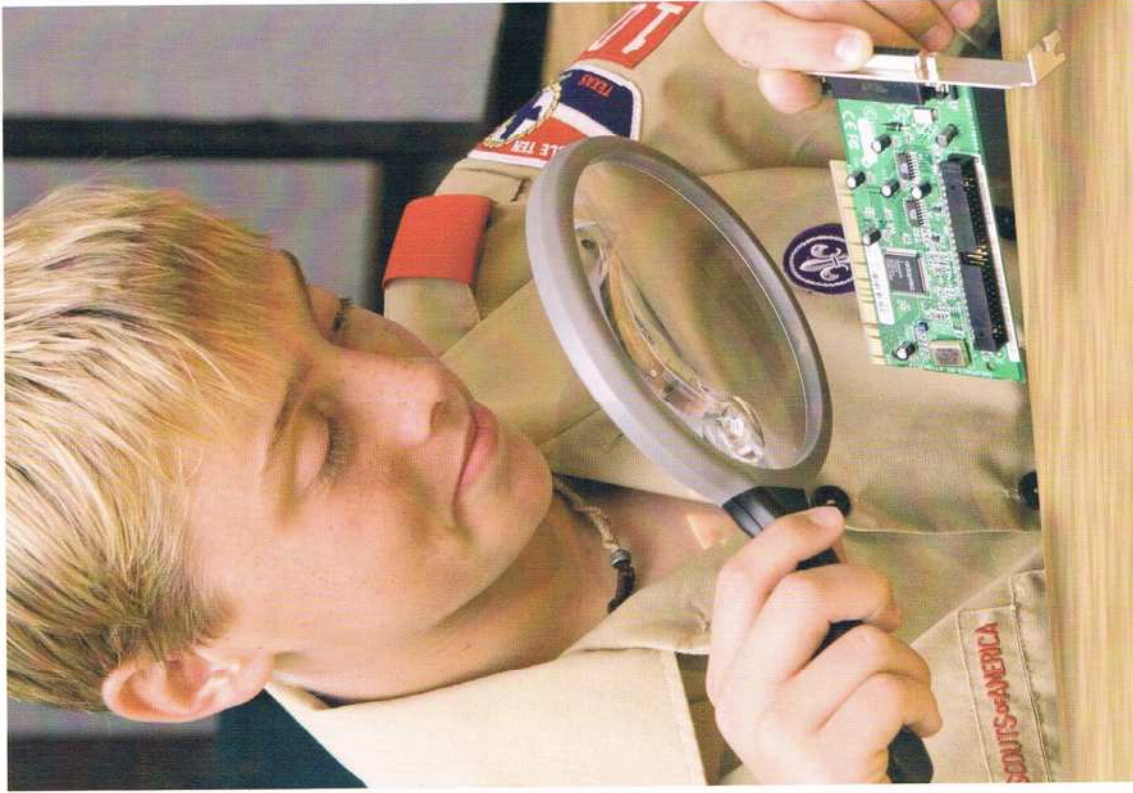

Parts Needed

- R₁ 100 kΩ potentiometer
- R₂ 100 kΩ resistor
- R₃ 10 kΩ resistor
- R₄ 4.7 kΩ resistor

Note: R₂, R₃, and R₄ can be 5 percent or 10 percent tolerance and either 1/2 or 1/4 watt.

- LDR Light-dependent resistor, cadmium-sulfide photocell
- Q₁ NPN transistor type 2N3053
- IC₁ 741 operational amplifier (op amp)
- PB Piezoelectric buzzer
- S₁ Single-pole, single-throw switch
- Perforated board approximately 3 × 4 inches (described on page 53)
- Four standoffs (legs) and screws
- Battery holder for 9-volt battery
- 9-volt battery
- Battery clip for 9-volt battery
- 4 feet of No. 24 insulated wire

Procedure

To build this circuit, follow these steps.

Step 1—Gather the parts. The most convenient place to get parts for this project is at a Radio Shack store. Parts also are available from various electronics supply stores or over the Internet (see the resources section at the back of this book). It's a good idea to make sure you can find all the parts before you buy any of them. This circuit will work with a wide variety of parts.

Step 2—Lay out the circuit board. Before you begin, decide where each component will go on the board. The illustration here shows a suggested layout. Lay the components on the board and trace the outline of each to make sure everything will fit properly.

Step 3—Drill the holes. You must drill several holes (see the illustration for the pattern) in the circuit board before mounting any components. The four holes at the outer corners are for the four standoffs, or legs, that will hold the circuit board. It is recommended that you buy a board that has these four holes already drilled. This will leave you with only three holes to drill. The first is the small hole for the battery holder. Make this hole slightly larger than the screw that holds the battery holder to the board. Two larger holes are required for the potentiometer and the switch. In each case, make the hole slightly larger than the part that is to be inserted through it. Drill the holes carefully so you don't damage the perforated board.

Step 4—Mount the IC. Attach the 741 op amp first. It must be mounted so that its pins are attached to foil patterns that allow additional components to be attached. Insert the IC in the top of the board.

Identify pin 1 of the IC as illustrated at the bottom of the schematic diagram shown here. Mark pin 1 on the board with a pencil so that it is easier to identify each of the pins as you solder components to them.

Step 5—Mount the LDR. Insert the leads of the light-dependent resistor into the board at the location shown and solder the leads to the foil. Don't worry about which lead is which. The LDR can be turned either way.

Step 6—Mount R₂, R₃, and R₄. Insert the leads of the resistors at the locations shown. Bend the leads over so that you can insert them through the board and solder them to the bottom side. Don't worry about which lead is which. The resistors can be turned either way.

Step 7—Mount the transistor.

Insert the transistor (Q₁) into the board, carefully observing the emitter, base, and collector connections. The drawing at the bottom of the schematic illustrated in step 4 shows how to identify the three elements.

Step 8—Mount the buzzer. Insert the buzzer (PB) through the board. Note that the minus (-) and plus (+) sides must be connected as shown in the schematic.

Step 9—Mount the switch. First remove the retaining nut. Mount the switch by pushing it through from the bottom of the board. Attach it to the board with the retaining nut. Cut two lengths of wire, each about 3 inches long. Remove 1/4 inch of the insulation from each end of the wire. Turn the board upside down and connect the switch lugs to the foil patterns using the two prepared wires as seen in the bottom view shown here.

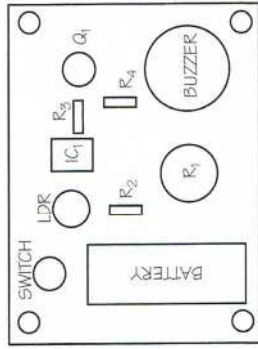

Suggested layout

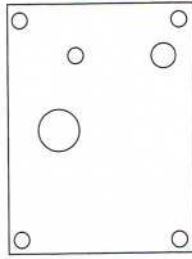

Hole pattern

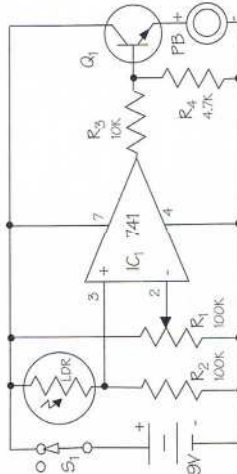

Schematic diagram, circuit board

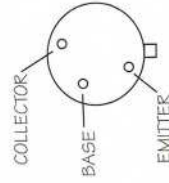

2N3053 viewed from bottom

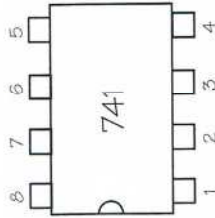

Viewed from top

Step 10—Mount the potentiometer. Remove the retaining nut. Mount the potentiometer (R_1) by pushing it through from the bottom of the board. Attach it to the board with the retaining nut. Cut three lengths of wire, each about 3 inches long. Remove $1/4$ inch of insulation from each end of the wire. Turn the board upside down and connect the potentiometer lugs to the foil patterns by using the three prepared wires as seen in the top view shown here.

Step 11—Mount the battery holder.

Step 12—Mount the battery clip. Strip $1/4$ inch of insulation from the ends of the battery clip's black and red leads. Solder the black and red leads to the board. Do not connect the battery yet.

Step 13—Interconnect the components. Use jumper wires to interconnect the components. A good way to do this is to refer to the schematic and color each line on the schematic as you connect that jumper wire on the board. Cut each wire to the length needed and remove $1/4$ inch of insulation from each end of the wire. Insert the jumper from the top of the board and solder to the foil on the bottom.

Step 14—Check all wiring. Before you apply power, recheck all wiring as described in the soldering section. Make certain that all components are interconnected properly. Check the pins of the op amp to make certain that you have the pin numbers right. Also recheck the placement of the transistor (Q_1).

Step 15—Apply power. Attach the battery clip to the battery. If the buzzer sounds, flip the on-off switch to the opposite position. Place the battery in the holder.

Step 16—Coarse-adjust R_1 . Flip the on-off switch to the "on" position. If the buzzer does not sound, adjust the potentiometer until you hear a sound from the buzzer. If you cannot make the buzzer sound by turning the potentiometer, flip the switch in the "off" position and adjust the potentiometer until the buzzer sounds. If the buzzer will not sound in either switch position, then immediately disconnect the battery and recheck all wiring. Correct the problem by rewiring as necessary. Repeat the process until you hear a tone from the buzzer.

Step 17—Fine-adjust R_1 . Once you get a sound from the buzzer, cover the LDR with a finger to block light from the device. With the LDR covered, back off the setting of the potentiometer just to the point where the buzzer no longer sounds. The buzzer should now sound when the LDR is uncovered but stop buzzing when the LDR is covered. The circuit is detecting the presence of light and responding by sounding the buzzer.

Circuit Operation

To understand how the circuit works, refer to the schematic diagram shown at step 4. Start at the buzzer (PB) and work backward. The buzzer will sound when current flows through it. Transistor Q_1 controls the current through the buzzer. When Q_1 conducts, current flows through Q_1 and the buzzer, creating the sound. In turn, the 741 op amp controls Q_1 . The 741 (IC₁) is an integrated circuit that contains dozens of transistors connected as a very high-gain amplifier. This means that it can amplify extremely tiny differences in the voltages applied to the two input terminals (pins 2 and 3).

The resistance of the light-dependent resistor (LDR) determines the voltage on pin 3 of the op amp. If no light strikes the LDR, the voltage is low. When light hits the LDR, its resistance falls and the voltage on pin 3 of the op amp increases.

Before using the circuit, carefully adjust the setting of R_1 . Moving the arm of R_1 changes the voltage at pin 4 of the op amp. With the LDR shielded from light, you set R_1 just below the point at which the buzzer is activated. When R_1 is properly set, the voltage at pin 3 is slightly lower than the voltage at pin 2. The op amp amplifies this tiny difference in voltage and produces a very low voltage at its output. This low output voltage holds Q_1 cut off so that no current can flow through the buzzer.

When light hits the LDR, as was noted, its resistance drops. This increases the voltage at pin 3 of the op amp. The op amp amplifies this difference, producing a high voltage at its output. This turns Q_1 on, forcing current through the buzzer and sounding the alarm.

Digital Electronics

Since the use of transistors began in 1948, the field of electronics has undergone a revolution that continues to allow for the introduction of a vast array of new devices. The development of digital electronic components has revolutionized fields such as computing, communications, and information handling. Such components have replaced many traditional circuits and components.

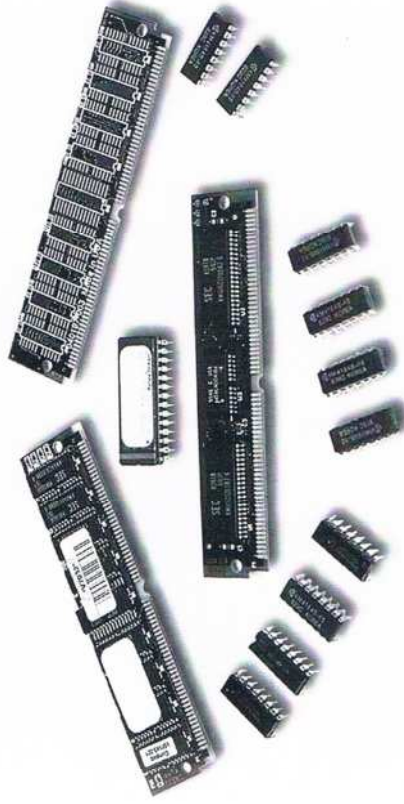

Possibly the best example of this revolution is the personal computer and related products. Other examples are digital watches, digital thermometers, hand-held computers and games, complex calculators, electronic games, televisions, and digitally recorded music and videos.



Binary Number System

To understand digital electronics, you must first learn the binary number system, which is used in digital equipment.

The decimal system of numbering uses 10 different digits: 0, 1, 2, 3, 4, 5, 6, 7, 8, and 9. This number system is suitable for people but is too complex to be used by electronic circuits. Digital logic is a simple process that can make only two decisions: true or false. So the binary number system has only two digits: 0 and 1. Thus, "true" can be represented by 1 and "false" by 0.

With only two digits, how are numbers larger than 1 represented? The answer is the same way numbers greater than 9 are represented in the decimal system. In the decimal system, the highest single-digit number is 9. We represent numbers greater than this by using two or more digits in combination. That is, 10 is represented by using the digits 1 and 0 together.

In the binary system, the highest single-digit number is 1. To represent numbers greater than this, we again use two or more digits in combination. The number 2 cannot be represented by the symbol "2" because this digit is not used in the binary system. Instead, the digits 1 and 0 must be used together, to form 10. Therefore, in the binary system, 10 represents the number 2 and not the number "ten." The number 3 is represented by the next larger two-digit number of 11.

Now, how do we represent the number 4 in binary? Since we no longer have two-digit possibilities, we must use a three-digit number. The lowest three-digit number is 100. In the decimal system, this means "one hundred." In the binary system, 100 means "four."

Here is a chart showing decimal numbers up to 17 and how to represent them using the binary system.

Study this table to help you understand the binary sequence. Then try to continue the list to 32 (decimal), or 100000 (binary).

Decimal	Binary
0	0
1	1
2	10
3	11
4	100
5	101
6	110
7	111
8	1000
9	1001
10	1010
11	1011
12	1100
13	1101
14	1110
15	1111
16	10000
17	10001

Changing Decimal to Binary

If you can divide by 2, you can convert decimal numbers to binary numbers. By repeatedly dividing a number, we can convert from decimal to binary. Remember that an even number divided by 2 will have a remainder of 0. An odd number divided by 2 will have a remainder of 1.

Let's convert the decimal number 8 to binary. You start by dividing 8 by 2, and then keep dividing the answer you get by 2.

8 divided by 2 = 4 with a remainder of 0
 4 divided by 2 = 2 with a remainder of 0
 2 divided by 2 = 1 with a remainder of 0
 1 divided by 2 = 0 with a remainder of 1
 We arrange the remainders like this:

1
0
0
0
0

This gives the binary number for 8: 1000. Check the decimal/binary chart shown earlier to make sure you are correct.

To practice again, convert 13 to a binary number.

13 divided by 2 = 6 with a remainder of 1
 6 divided by 2 = 3 with a remainder of 0
 3 divided by 2 = 1 with a remainder of 1
 1 divided by 2 = 0 with a remainder of 1
 Arrange the remainders:

1
1
1
0
1

Check the decimal/binary chart and you will see that 1101 is the binary equivalent of 13.

Changing Binary to Decimal

Changing numbers in the opposite direction is just as easy.

Let's convert the binary number 1001 to its decimal equivalent. In a way, we will do the opposite of what we just did; that is, instead of dividing by 2, we'll multiply by 2. First, write the binary number with the digits spread apart, like this:

1 0 1 1

Under the digit on the right, write the number 1. Multiply 1 by 2; the answer is 2. Write 2 under the next number. Multiply 2 by 2 (equals 4), and write 4 under the next number. Multiply 4 by 2 (equals 8) and write 8 under the next number:

1 0 1 1
8 4 2 1

Now, add together the bottom numbers that appear under a 1.

In the example, 8, 2, and 1 are written under 1s, so $8 + 2 + 1 = 11$. Check the decimal/binary chart and you will see that 11 is the decimal number for 1011.

Here's another example. Convert the binary number 10110 to a decimal number:

1 0 1 1 0
16 8 4 2 1

Adding the numbers under 1s, you get $16 + 4 + 2 = 22$.

Try some conversions on your own, checking the answers on the decimal/binary chart.

Logic Circuits

Digital electronic devices consist of circuits called *logic gates*. A logic gate is a collection of transistors and resistors connected to perform a desired operation. The three basic types of logic gates are the *AND* gate, the *OR* gate, and the *inverter*, or *NOT*.

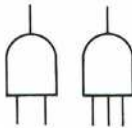

AND gates

stands for the number 1. A common arrangement is to let 0 volts represent the number 0 and to let +5 volts represent the number 1. An AND gate produces a 1 output only when all inputs are 1s. Or, it could be said that the output of an AND gate is true only if all inputs are true. So, for the arrangement explained above, the output of the AND gate is +5 volts (1) only when all inputs are +5 volts (1). If either input is 0 volts (0), the output will be 0 volts (0).

This gate is called an AND gate because the output is 1 only if input one *and* input two are both 1s. Some AND gates have more than two inputs. However, the operation performed is the same. For this reason, the AND gate can be thought of as an "all or nothing" decision circuit.

The illustration shows the logic symbol used in schematic diagrams for the AND gate. The inputs are shown on the straight side, the output on the curved side.

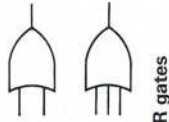

OR gates

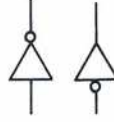

Inverters

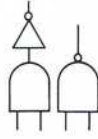

NAND gate

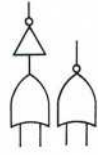

NOR gate

Inverter

The inverter has a single input and a single output terminal. If the input is 0, the output is 1. If the input is 1, the output is 0. That is, the inverter reverses, or inverts, the input.

Other Gates

Two other types of logic gates are used in digital electronics. One is the NAND gate. This circuit is composed of an AND gate and an inverter that are connected together. The output of the AND gate is applied to the input of the inverter as shown. Generally, the logic symbol for the NAND gate is simplified, as shown here.

An OR gate and an inverter can be connected to form a NOR circuit. The output of the OR circuit is inverted as shown.

Logic gates generally are

made in integrated circuit form.

A single IC package may contain four NAND gates or six inverters.

Digital Equipment

Connected in various ways, the basic logic gates can perform many different operations. Circuits have been devised to count, add, subtract, remember numbers, and solve complex problems. Large numbers of these circuits can be connected to form an array of useful electronic equipment. Sometimes, microprocessors perform many of the switching and timing functions of individual logic elements. The processors are programmed with instructions to perform a given task or tasks. Let's look at some popular digital devices.

Computers

A computer can rapidly solve a wide range of problems and provide many other important functions. Computers are complex enough to be used to control spacecraft and airliners in flight. They are used in industry for calculating payrolls, for keeping records, word processing, and for inventory control, among other things. Besides "crunching numbers" for those functions, computers also can store and process data that are not mathematical in character. Such nonmathematical functions include ticket control by airlines, library record keeping, and even translating languages from one to another.

In the 1950s, very few people had television sets. Now almost everyone does. The same thing has happened with the personal computer (PC) over the past 20 years or so. Once rare, now they are commonplace. Initially designed for individual use, PCs can be connected to form networks in a single office or all over the world.

Personal computer with shell removed

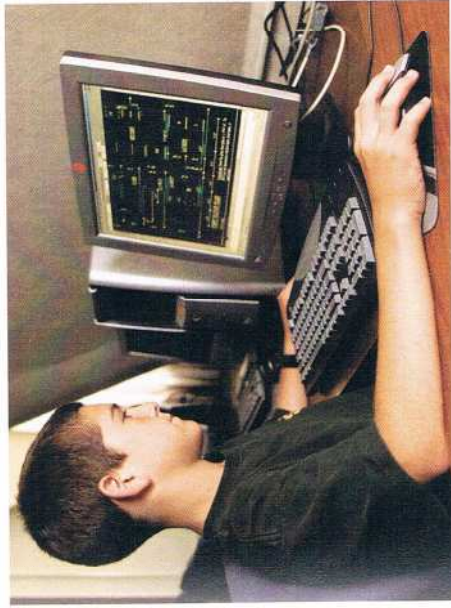

Computers have essentially replaced the typewriter for writing and have many other uses, such as for sending faxes, communicating through electronic mail (e-mail), and drawing, as well as for entertainment.

To use a computer, we must communicate with it. First, a programmer must write a *program*, or a set of instructions, that the computer's processor can understand. The program is designed to perform a needed task. The computer follows the program's instructions and performs the task. Most computer programs are extremely complex and are developed by several programmers at companies that specialize in developing these programs. Consumers usually buy these programs in the form of *software*. The computer and what it is connected with (such as printers) are the *hardware*.

The user, or operator, communicates with the computer through input devices such as a keyboard, a mouse, and a monitor, which can resemble a small TV set. The user enters information directly into the machine through the keyboard and interacts with application programs that usually have been stored on the PC's storage device, such as a hard disk (commonly called a *hard drive*). This is an inflexible platter or platters that are coated with material that allows the magnetic recording of data.

Electronic Calculators

A calculator uses the same type of arithmetic circuits as a PC uses, but the method of entering data and displaying the answer is more simplified. The operations of early calculators were generally limited to a few mathematical functions, but newer ones can perform many complex functions.



Digital Clocks and Watches

Digital clocks and watches are replacing their mechanical counterparts. In these devices, an extremely accurate oscillator produces thousands of pulses each second. Electronic circuits count these pulses and convert them to a display of the time in hours, minutes, and seconds. Because circuits are smaller and more powerful, the wristwatch of the past, with an hour hand, minute hand, and sweeping seconds hand, is becoming replaced with an instrument that can display time, the date, and your heart rate as well as serve as a timer and stopwatch.



Test Equipment and Other Devices

Digital techniques offer several advantages in electronic test equipment (see the section on Electronic Test Equipment). Digital voltmeters generally are more accurate and easier to read than the meter-movement type of instrument. Other test instruments include the frequency counter, oscilloscope, multi-meter, cable checker, and clamp meter.

Several other types of digital equipment are becoming increasingly popular, especially in the fields of entertainment and communications. Digital techniques now allow for better TV reception, and digital techniques are used in electronic musical instruments, audio and video recording, transmitters, appliances, video games, and mobile phones.

Digital Counter

To fulfill requirement 4 you can build a digital circuit with a kit project. But you may want to build something from scratch, such as the digital counter shown here. Before you begin construction, read this section on how such a circuit operates.



Digital counter



0 1 2 3 4 5 6 7 8 9

Seven-segment display

Circuit Operation

The circuit is a counter that has both a binary and a decimal counter. It counts the number of times that the push-button switch is depressed. The light-emitting diodes—called LEDs—on the right display the count as a binary number. The seven-segment display on the left gives the count as a decimal number. The highest count the circuit can display is 9.

As the schematic diagram for a digital counter shows, most of the circuit is composed of three integrated circuits. The 7490 IC is a binary-coded decimal (BCD) counter. BCD is a compromise between the binary system and the decimal system. The counter

A light-emitting diode (LED) is a semiconductor that produces light when an electric current passes through it. A common use is in the seven-segment display used in digital clocks and watches. The display consists of seven LEDs labeled *a* through *g*. The diodes are arranged as shown. Lighting the proper segments can form any digit from 0 to 9. If segments *a*, *b*, and *c* are lit, they form the digit 7. When all segments are lit, they form the digit 8.

sequences from 0 to 9. Each decimal digit is represented by a count. However, the count is in binary. Thus, the counter follows this sequence (starting at the left column and going down; decimal is shown in parentheses):

0000 (0)	0011 (3)	0110 (6)	1001 (9)
0001 (1)	0011 (3)	0111 (7)	0000 (0)
0010 (2)	0101 (5)	1000 (8)	0001 (1)
			and so on . . .

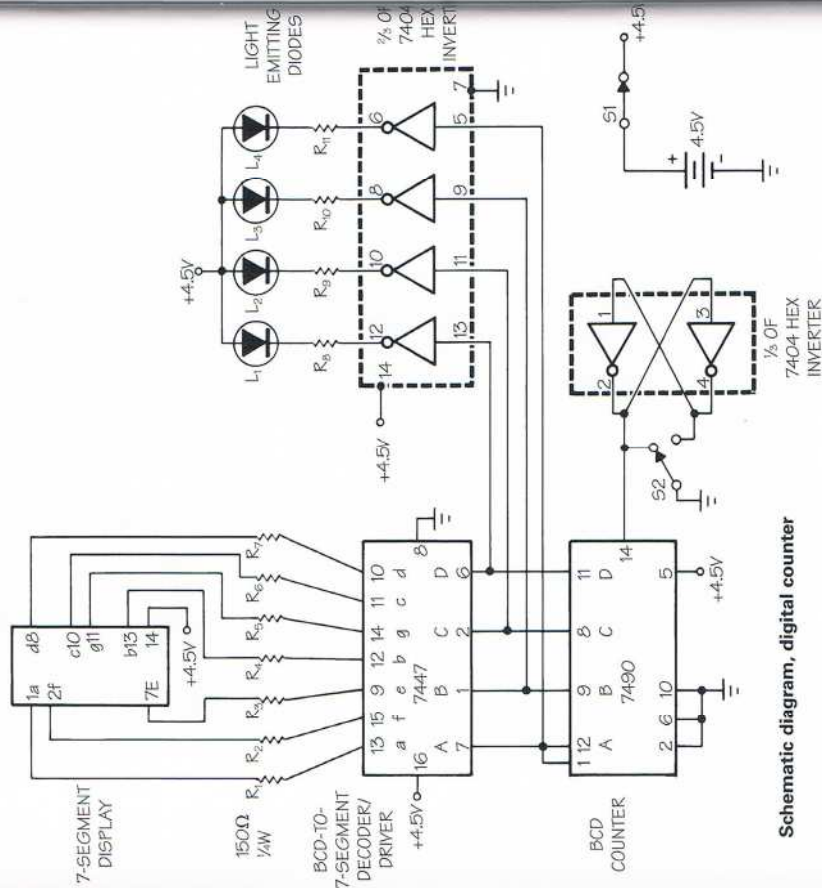

Schematic diagram, digital counter

Notice that the circuit counts from 0 to 9 and then recycles to 0 and starts over. The count advances once each time the push-button switch (S_2) is depressed.

The counter has four output lines, labeled A, B, C, and D on the schematic. Each line carries one of the digits of the binary number.

The binary number is applied to the BCD-to-seven-segment decoder/driver. This circuit is a 7446 IC. Its purpose is to decode the binary count and drive the proper segments of the display. It accepts the binary number and converts it to a form suitable for driving the seven-segment display.

Parts Needed

- 1 plastic box (3 1/2 x 2 x 6 inches is recommended)
- 1 perforated board (1/10-inch hole pattern)
- 1 SN7490 or 74LS90 BCD counter, IC
- 1 SN7447 or 74LS47 BCD-to-seven-segment decoder/driver, IC
- 1 single-pole, single-throw switch (S_1)
- 1 single-pole, double-throw push-button switch (S_2)
- 3 battery holders
- 3 D cells
- 4 light-emitting diodes
- 1 SN7404 or 74LS04 hex inverter, IC
- 1 seven-segment LED display, common anode type (MAN71A) or equivalent (available through most electronics distributors)
- 11 150-ohm 1/4-watt or 1/2-watt carbon resistors (R_1 through R_{11})
- 3 14-pin dual in-line IC sockets (optional)
- 1 16-pin dual in-line IC socket (optional)
- 22 terminal posts (optional)
- 6 feet of small insulated wire (No. 26 is recommended)

The digital counter also has a binary display. Four inverters in the 7404 IC drive four LEDs. The inputs of these inverters also come from the 7490 IC. The four inverters provide the current necessary to drive the LEDs.

Two inverters in the 7404 IC are used in connection with the push-button switch (S_2). Some switches have a momentary "bounce" when operated. That is, they open and close several times because of vibrations within the switch. While this happens too fast for us to see, the counter will respond to the bounces. In this case, the counter would appear to be counting incorrectly. The purpose of the two inverters is to eliminate the effects of the contact bounce.

The types of ICs used in this project normally operate with a supply voltage of 5 volts. However, they will operate satisfactorily from 4.5 volts achieved by connecting three D-cell batteries in series. S_1 serves as the on-off switch. Resistors R_1 through R_{11} are used to hold the current for the displays down to an acceptable level.

Building the Circuit

This circuit for a digital counter may challenge your soldering ability and will require patience, but you can do it. The pins on the ICs are only $1/10$ inch apart, which means that it will be extremely easy to bridge (connect) two of these pins with solder. (See the illustration in the "Soldering" chapter that shows a solder bridge.) When and if this happens, you must remove the bridge, using one of the desoldering techniques you have learned.

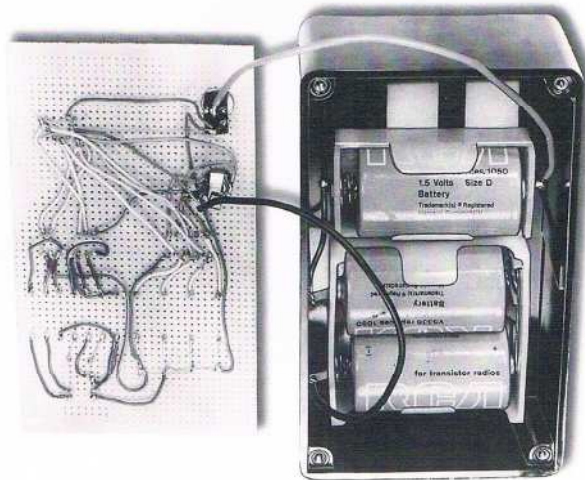

Digital counter, interior view

Construct this circuit on a perforated board. The board must have a hole pattern suitable for ICs; that is, the holes must be $1/10$ inch (0.1) apart. Boards of this type are common.

Mount all components except the batteries on the board. The ICs and the seven-segment display can plug directly into the board, or you can use IC sockets. Solder the resistors to terminal posts as shown, or bend the leads and insert them directly through the board.

Make all interconnections on the bottom of the board. Solder wires directly to the leads of the ICs or the IC sockets. In some cases, you must solder two wires to a single pin. It is recommended that you use very small insulated wire, such as No. 26, for this purpose. Also, you must use a very small tip on your soldering iron.

Mount the three D cells in the plastic box. You can use double-sided tape to secure the battery holders in place. Make certain that the box you buy is big enough to hold the batteries.

The perforated board serves as the top of the box. Buy a board that is the same size as the box, or one that is large enough so that you can cut it down to fit the box.

Take extreme care if you need to cut the board. Most boards are brittle and break easily. Buy switches that will mount in small round holes. As with cutting the board, you need to be careful when drilling holes.

You must properly connect the LEDs (L_1 through L_4) before they will light. The anode leads must be connected together and to the positive side of the battery. The package in which the diodes come should show you how to identify the anode leads. If it doesn't, follow this procedure:

- Connect three D cells together as illustrated.
- Temporarily solder a 150-ohm resistor to the negative terminal of the first battery holder. Temporarily solder an insulated wire to the positive terminal of the last battery holder.
- Touch one lead of the LED to the free end of the resistor. Touch the other lead of the LED to the free end of the insulated wire.
- If the LED lights, the anode is the lead connected to the wire. If it does not light, the anode lead is connected to the resistor.
- Turn the LED around and verify that it lights when the anode lead touches the wire.

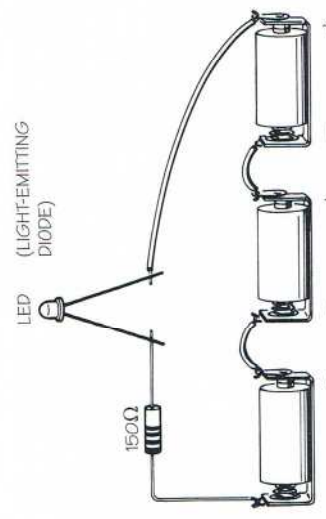

Identifying the anode lead

It is also important to identify the pins on the ICs. The IC packages might show you how. If not, you can identify the pins in one of the ways shown here. Notice that there is always an orientation mark, such as a notch, an indentation, or a dot of paint. When the orientation mark is on the left (as shown), pin 1 will be the lower left pin. The other pins are always numbered in the sequence shown.

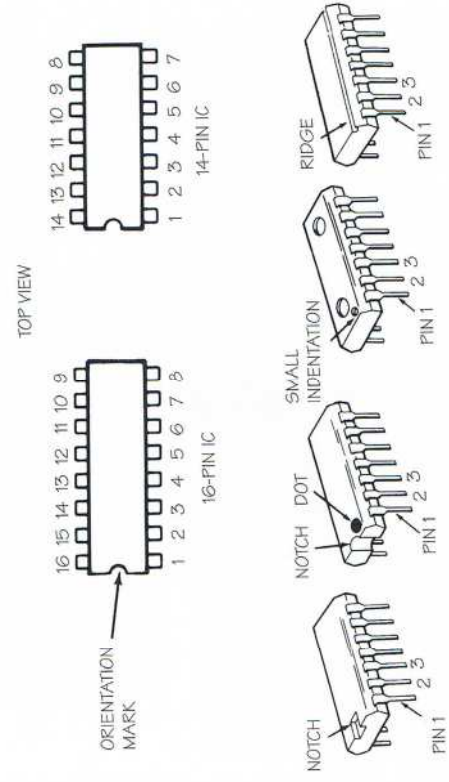

Identifying the IC pins

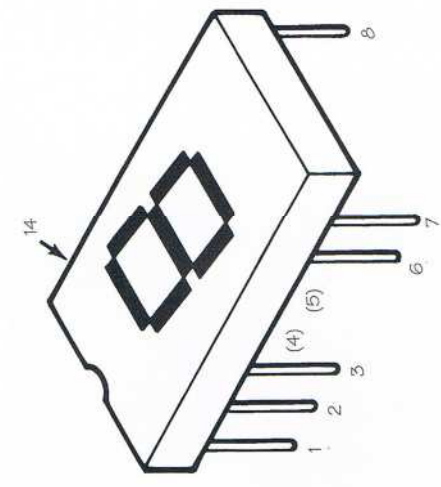

Identifying the seven-segment display pins

You can identify the pins on the seven-segment display in much the same way. An orientation mark is used to identify pin 1. Then the pins are numbered in the same way as for 14-pin ICs. However, there might be one important difference: Some seven-segment displays do not have 14 pins; some use as few as 10. When numbering the pins, you must count the space where a pin would normally be. In the example shown here, pins 4 and 5 are missing; nevertheless, you count those spaces as pins.

In some seven-segment displays, the pins might be numbered differently from the way they are shown in the schematic or wiring diagram. Check the instructions that come with the display. The important thing to remember is that the "a" output of the 7447 IC should connect to the "a" input of the display regardless of which pin on the display this happens to be.

Notice that the illustrations show the top views of the pin arrangements. When soldering to these ICs, you will be viewing them from the bottom. Don't let this confuse you.

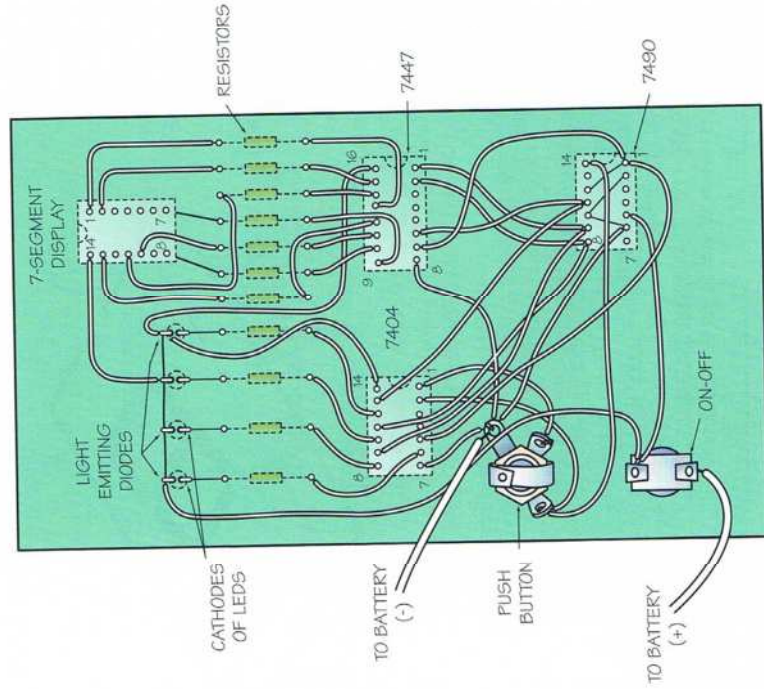

Wiring connections, bottom view

To simplify things, it is a good idea to first mount all ICs. Insert the leads of each IC or IC socket through the holes in the board. Temporarily tape the ICs or sockets in place to prevent them from falling off when you turn the board upside down. Then turn the board over and label each pin number. You can write directly on the board with a pencil or pen. This illustration shows all the wiring connections as viewed from the bottom side of the board.

Refer to the pictorial and the schematic diagram as you solder each connection. Take your time and work carefully. Make certain there are no solder bridges between pins. When

you are done, recheck everything before applying power. Lastly, insert the batteries in their holders and turn on the device.

When the power switch is turned on, some segments of the seven-segment display should be lit. These segments might or might not form a recognizable digit number. Depress the push button several times until a "0" is displayed. The count should now advance once each time the push button is pressed and released. Upon reaching a count of 9, the device should recycle to 0.

Notice the four LEDs in the diagram. These displays should be counting in binary. When the LED is on, it represents 1; when the LED is off, it represents 0. The binary count should always agree with the decimal count.

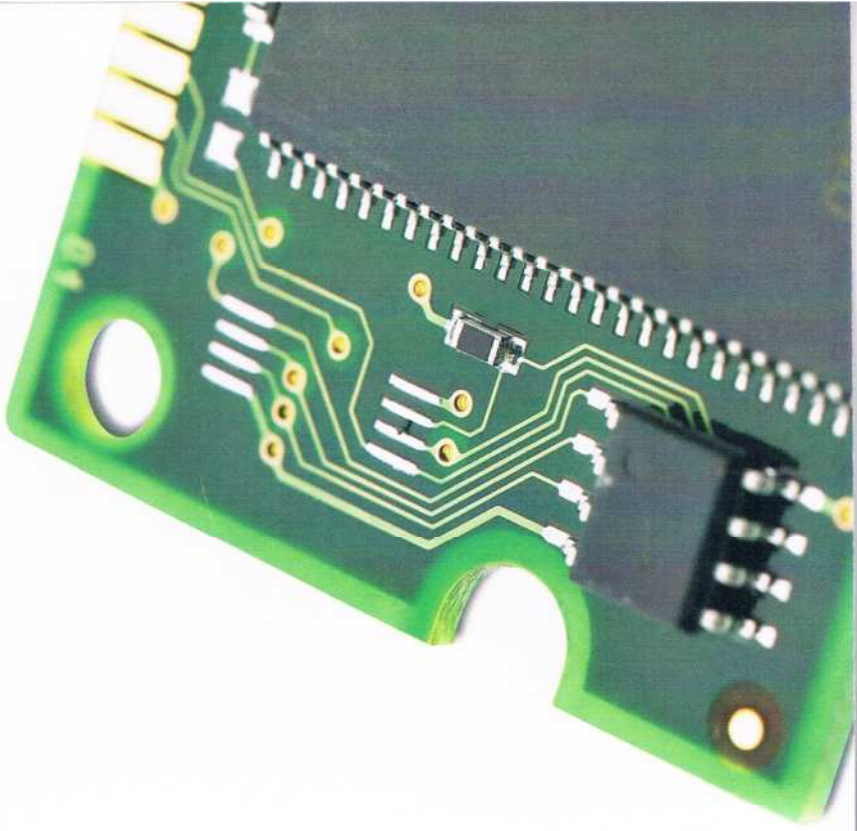

Audio

The field of audio deals with frequencies that are within the range of human hearing. Devices such as compact disc (CD) players, DVD (digital versatile disc) players, MP3 (high-quality sound files compressed into digital format) players, cassette recorders, stereos, receivers, public address systems, and electronic musical instruments are among audio equipment.

What Is Audio?

When we strike middle C key on a piano, the sound we hear is caused by a vibrating wire. The wire vibrates about 260 times each second. This causes the molecules in the air to vibrate at the same rate, producing a mild shock wave that travels in all directions. When the wave reaches us, our eardrums vibrate at the same frequency. As a result, we hear a pleasing tone of the same frequency produced by the piano.

Middle C frequency is about 260 cycles per second, or 260 hertz (Hz). The piano's lowest note is about 27 Hz; the highest is higher than 4,000 Hz. Most people easily hear both extremes. A person with good ears can hear frequencies between 15 and



20,000 Hz. These extremes are considered the limits of the audio-frequency range. Audio equipment is used to produce, record, amplify, or reproduce frequencies in this range.

Most audio equipment falls in one of these categories:

- **"Hi-fi stereo" field.** A good CD player will faithfully reproduce any sound within the audio range. That is, it might have a frequency response from 15 to 20,000 Hz. Newer technology includes DVD-audio and SACD (super audio CD). DVD-audio has a frequency response up to 96,000 Hz, and SACD reaches 100,000 Hz.
- **The spoken word.** Public address systems and intercoms are in this category. The human voice covers a narrow frequency range (about 100 to 3,000 Hz), so the frequency response of such systems need not cover the entire audio range.
- **Musical instruments.** Electronic keyboards, synthesizers, and electric guitars are examples. These instruments produce a wide range of frequencies and can create many special effects.

Audio Project

Low-cost electronics kits are available that will satisfy requirement 4. However, you can build a simple audio device from scratch fairly easily, such as the electronic siren shown here. It produces a sound similar to a police siren. The frequency of the wail slowly increases as you hold down a push button, and when you release the button, the frequency of the wail slowly decreases.

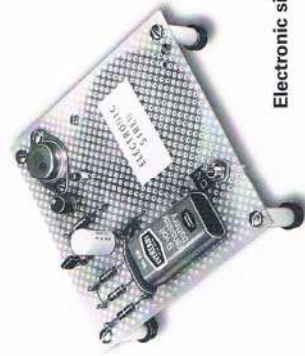

Electronic siren

Parts Needed

- Capacitor C₁ 50 microfarads, 12 volts, electrolytic
- Capacitor C₂ 0.018 microfarad, 25 volts or greater
- Transistor Q₁ NPN, SK-3020 or equivalent
- Transistor Q₂ PNP, SK-3009 or equivalent
- Resistor R₁ 27 k Ω , 1/2 watt, 10%
- Resistor R₂ 68 k Ω , 1/2 watt, 10%
- Resistor R₃ 56 k Ω , 1/2 watt, 10%
- Resistor R₄ 470 ohms, 1/2 watt, 10%
- Switch S₁ Single-pole, push-button
- Switch S₂ Single-pole, single-throw
- Speaker 3.2 to 8.0 ohms
- 9-volt battery
- Battery clip
- Perforated board
- Terminal posts (optional)

Circuit Operation and Construction

The schematic diagram shown here is for the electronic siren.

When S₁ is closed, capacitor C₁ begins to charge. As it does, it makes the base

of Q₁ more and more positive. This slowly turns on Q₁. Current through Q₁ turns Q₂ on; Q₁ and Q₂ form a direct-coupled amplifier.

Part of the output from Q₂ is applied to the input of Q₁ through capacitor C₂. This provides the regenerative (restoring)

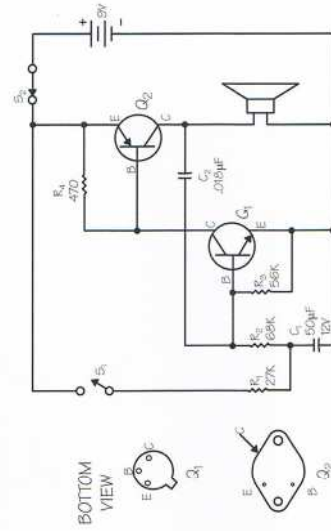

Schematic diagram, electronic siren

feedback that causes the circuit to oscillate (fluctuate). When switch S_1 is opened, C_1 discharges through R_2 and the base of Q_1 . You can change the "wailing rate" of the siren by changing the values of R_1 and C_1 . An increase in the value of R_1 or C_1 lengthens the time period during which the frequency of oscillation increases.

Battery drain with switch S_1 open is only about 400 microamperes. Therefore, power switch S_2 is not necessary. But such a switch will add to battery life.

You can get good results by building the circuit on a perforated board. All components except the speaker mount on top of the board. The illustration here shows all wiring connections as viewed from the bottom of the board. You can place the completed unit in a plastic box, or simply support the board on standoffs (legs) as shown.

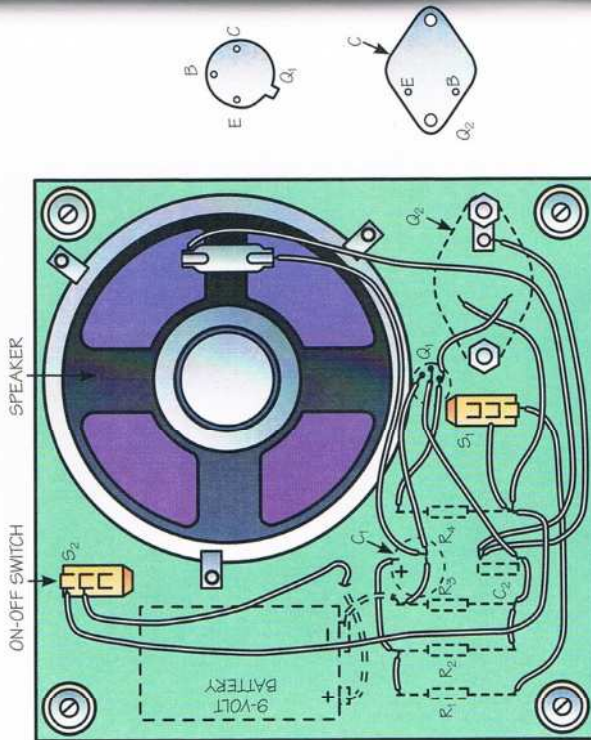

Wiring connections, bottom view



Electronic Test Equipment

Test equipment includes the instruments that are used to diagnose the operation of electronic circuits. The most popular types of test equipment are meters, oscilloscopes, and signal generators. You should use such equipment with someone who has experience using electronic test equipment.

Meters

Meter movement. In electronics, meters are used to measure current, voltage, and resistance. Both analog and digital meters are popular, although digital meters continue to replace most analog meters. Digital meters are considered easier to use and to read.

In electronics, *analog* means a device or signal that is continuously varying in strength or quantity, such as a sound wave, rather than being based on separate units, such as used in the binary system of 0 and 1.

You have learned how basic digital technology works. How does an analog meter work? The heart of the analog meter is the meter movement. The meter movement consists of a coil of fine wire wound on a tight aluminum frame. The frame is suspended and free to rotate. The coil has leads attached so that current can be forced through it. The coil is suspended in the field of a permanent magnet. When current flows through the coil, a magnetic field develops around it. This field interacts with the field of the permanent magnet. The interaction of the two fields causes the coil assembly to rotate.

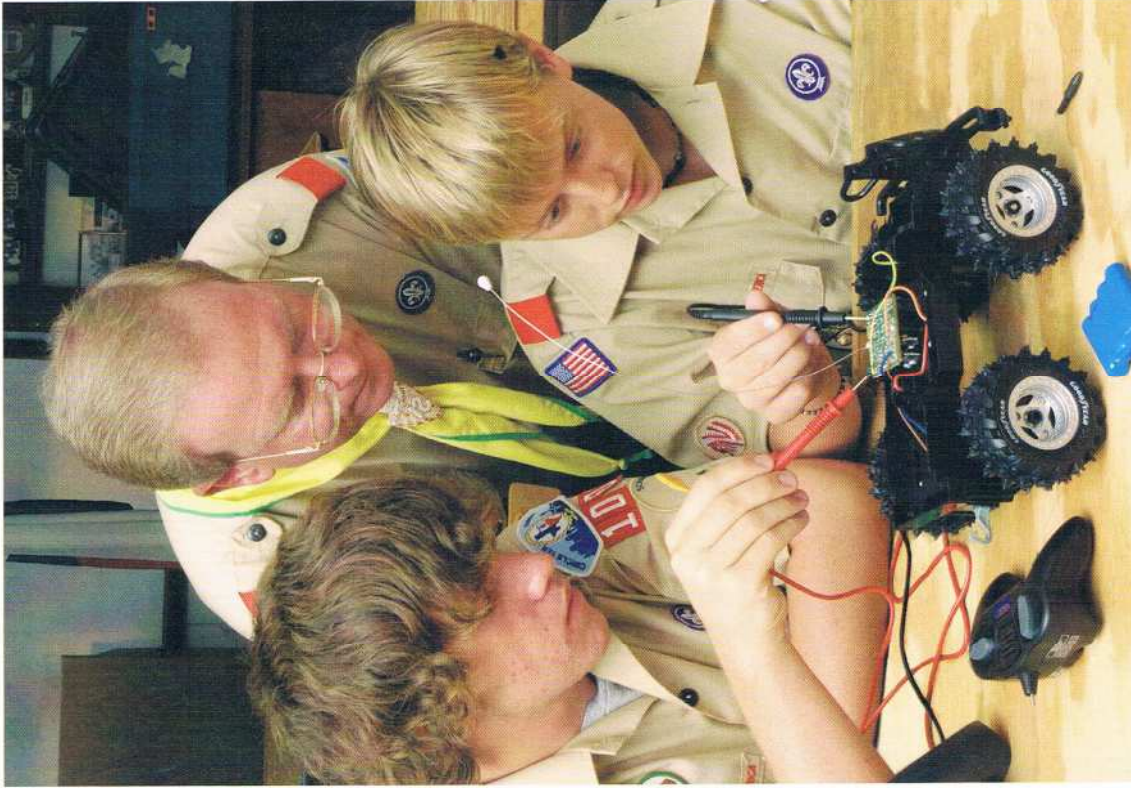

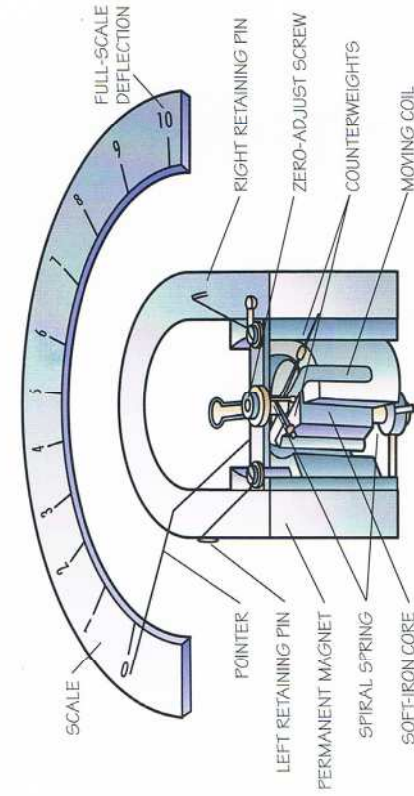

Analog meter movement

The coil has a pointer attached to it, and as the coil rotates, it moves the pointer in front of a scale. The more current that flows through the coil, the farther the coil will rotate. This forces the pointer to move farther up the scale.

Ammeter. The ammeter is designed to measure current. The meter movement alone can be used as an ammeter. Normally, though, a range switch is added so that the meter can measure a wide range of current. We change ranges on an ammeter by switching different values of shunts across the meter movement, as shown in the schematic of an ammeter. *Shunts* are small-value resistors that act as bypasses. They detour some of the current around the meter movement.

An ammeter is delicate and easily damaged. It must be connected to the circuit so that the current to be measured flows through the meter. For this reason, the circuit being tested must be broken to insert the ammeter.

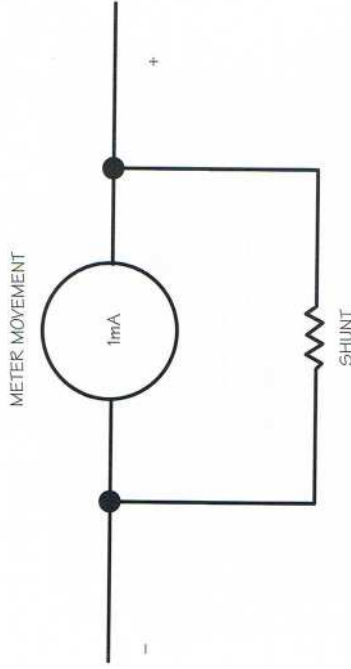

Schematic of an ammeter

Voltmeter. The voltmeter is designed to measure voltage and uses the same type of meter movement as an ammeter. The voltmeter is connected across the voltage to be measured. To measure voltage between two points, touch the negative lead to the more negative point and the positive lead to the more positive point. The circuit under test need not be broken or interfered with in any way.

A low voltage can be applied directly to the meter movement. A higher voltage, however, might cause a high enough current to burn out the delicate coil. For this reason, a large-value resistor is connected in series with the meter movement. This resistor limits the amount of current flowing through the coil. Also, the meter should be set at the proper range. For instance, you shouldn't try to measure 100 volts with the meter set to the 1-volt range. Use the meter set on the high range if you are unsure of the voltage being measured.

The range of the voltmeter is changed by switching different values of resistors in series with the meter movement. On a given range, the voltage across which the leads are connected determines the current that flows through the meter. The meter scale can be marked off in volts.

When using a voltmeter, hold the meter leads *only* by the insulated portions to avoid getting an electrical shock.

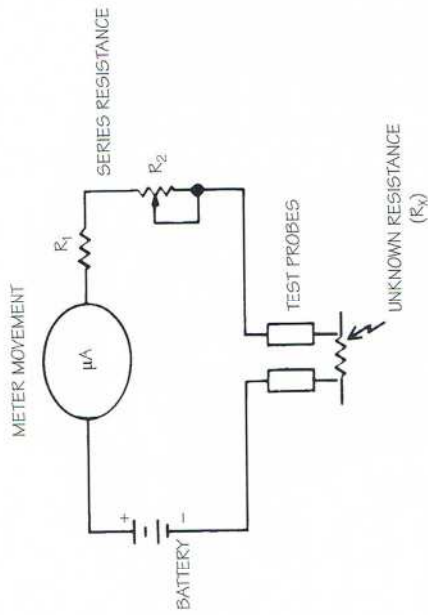

Schematic of an ohmmeter

Ohmmeter. The ohmmeter measures resistance. It consists of a meter movement and a battery connected together. The ohmmeter should not be connected to a circuit that has power applied because the meter could be easily burned out if it is connected across a voltage.

The resistance to be measured is connected across the ohmmeter leads. The battery forces current through the resistance and through the meter movement. The amount of current depends on the resistance value under test. The range of the ohmmeter can be adjusted. For example, if the range is $R \times 1$, then a reading of 9 would measure 9 ohms. But if the range is set at $R \times 1,000$, then a 9 reading would mean 9,000 ohms (or 9 k Ω).

Multimeter. The three types of meters we have just looked at use the same type of meter movement. For this reason, the ammeter, voltmeter, and ohmmeter can be combined in a single instrument called a multimeter, which displays the values of voltage, current, and resistance. A switch changes the meter movement from one function to the other. The multimeter is the most common piece of test equipment used in electronics work.

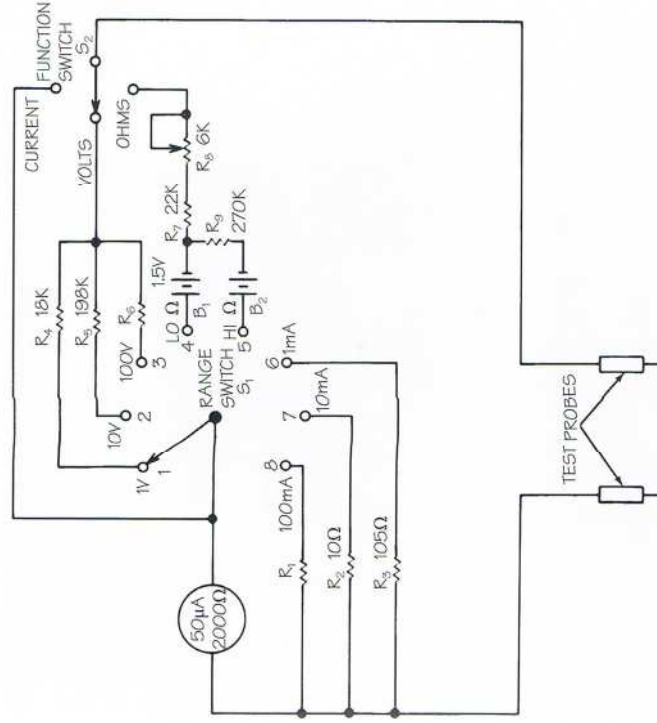

Schematic of a multimeter

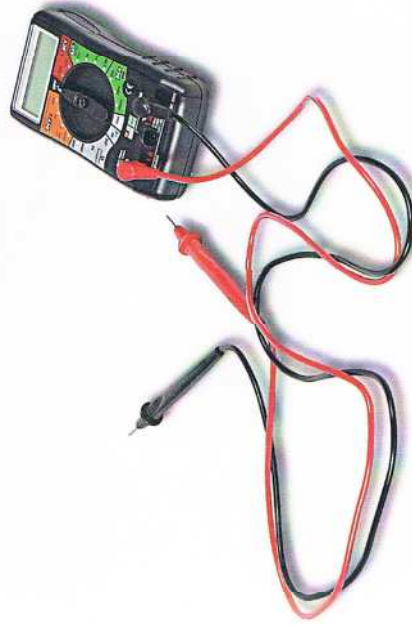

These days, digital multimeters are the most popular.

Oscilloscopes and Signal Generators

An *oscilloscope* looks something like a small TV, but the screen, or cathode-ray tube (CRT), shows voltage wave shapes. This lets you know how the voltage in a circuit changes over time.



Oscilloscope

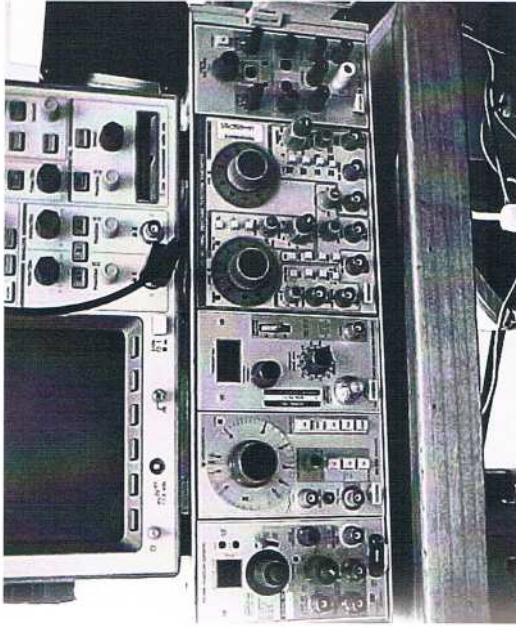

Signal generator

Many different types of *signal generators* are used in electronics. The most common are used to align communications equipment and diagnose problems. These signal generators act as tiny replicas of transmitting stations. They allow service technicians to inject the proper type of signal at various points throughout the circuit. For this reason, the signal generator is a valuable troubleshooting aid. Many of today's signal generators can be hooked up to a PC, and the diagnosis can be seen on the computer monitor.

Careers in Electronics

The electronics industry has several general areas with many types of careers available in each area. These areas include manufacturing, merchandising, operating, servicing or maintaining, and engineering electronic parts and equipment.

Training requirements vary in each area. Some positions require a college degree, while a degree from a vocational school is adequate for other careers. Some companies allow on-the-job training, but almost all require at least a high school diploma.

- In *electronics manufacturing*, most positions are in factories. Occupations include assemblers, that is, the people who help build electronic equipment. A high school education is needed as well as mechanical aptitude.
- *Merchandising*, or sales, is another field for those interested in electronics. Someone who has technical knowledge and enjoys talking with and meeting people could do well in electronics sales. Education can include a high school diploma or degrees from vocational schools and/or college.

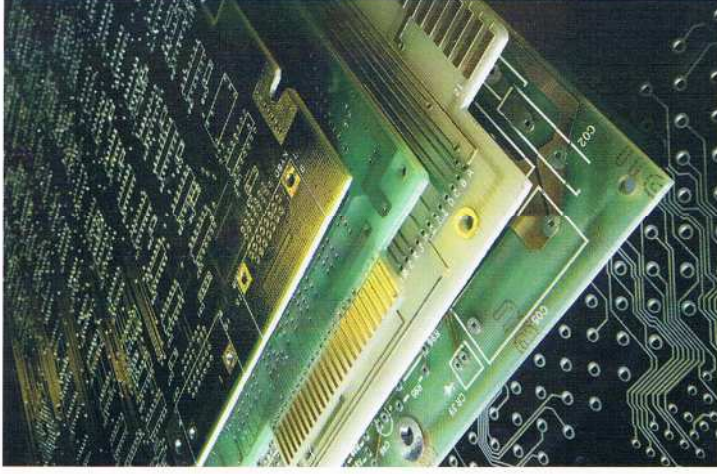
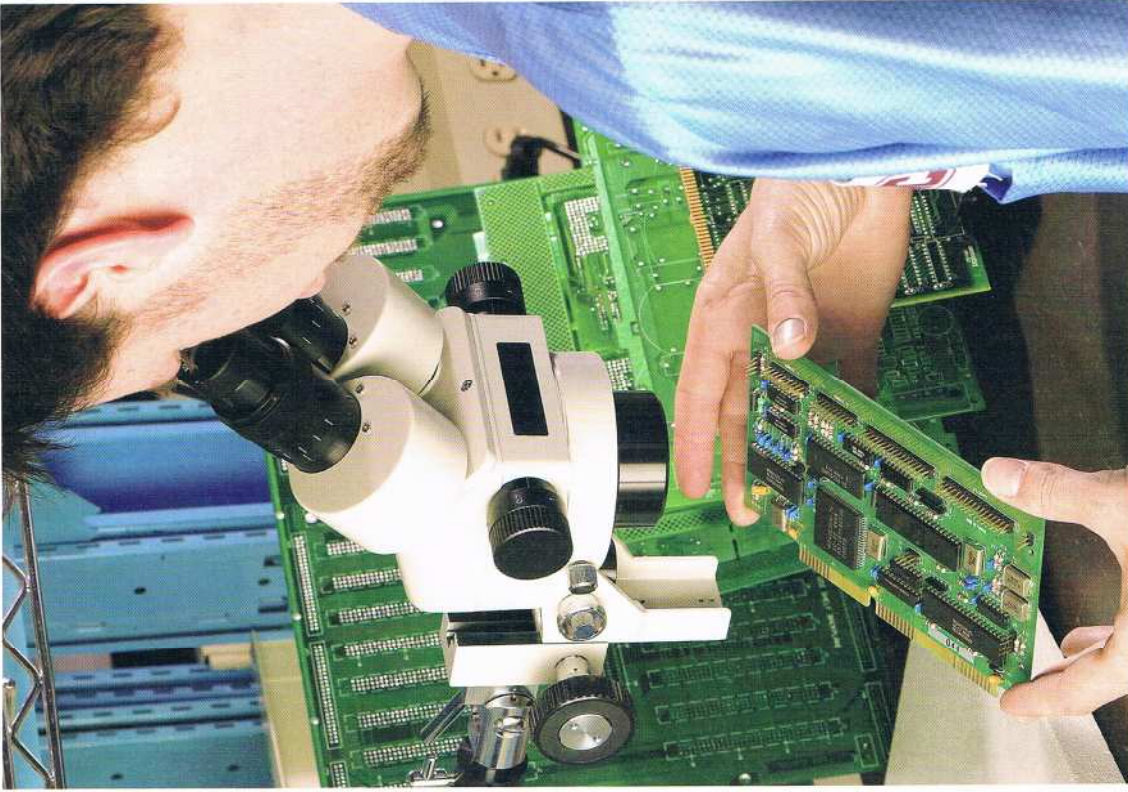

- Many types of electronics equipment are so specialized that they require trained *operators*. An operator might work with computers and computer network systems, cameras, satellite tracking devices, ship radios, or medical machines. In some cases, the operators must maintain and repair their own equipment. Education in a vocational school, a degree from a college or university, or training in the military usually is needed for these positions.
- Because of the complexity of many electronic machines, *service and maintenance* people are always needed. Any electronic device can fail or malfunction from time to time, and people are needed to make quick and expert repairs.

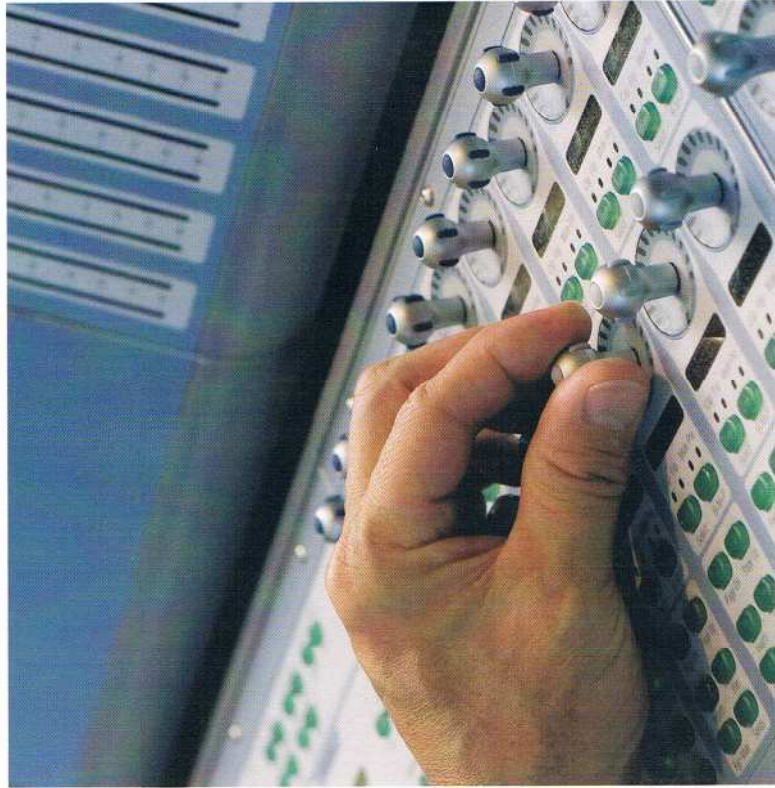

- *Technicians* can have a variety of positions. They might be required, among other things, to turn engineering ideas into hardware, to repair equipment, or to calibrate (adjust) test instruments. Most technicians have one or two years of technical training after high school. Some receive training in the military, and others go to a vocational school or junior college. Some receive on-the-job training or study at home by correspondence. Many occupations require continuous training so that technicians remain current with changing technology.
- *Electronic engineers* usually have a bachelor's degree or higher in engineering. As with technicians, engineers must constantly update their education to keep abreast of new components and techniques. A highly trained electronics engineer might design electronic equipment or large electronic systems.



Electronics Resources

Scouting Literature

Computers, Electricity, and Radio merit badge pamphlets

Visit the Boy Scouts of America's official retail Web site at <http://www.scoutstuff.org> for a complete listing of all merit badge pamphlets and other helpful Scouting materials and supplies.

Books

Bartholomew, Alan. *Electric Gadgets and Gizmos: Battery-Powered Buildable Gadgets That Go!* General Distribution Services, 1998. Includes directions for an assortment of electronics.

Bonnet, Bob. *Science Fair Projects With Electricity & Electronics*. Sterling Publishing, 1996. Includes nearly 50 projects on electricity and electronics.

Bridgman, Roger. *EyeWitness: Electronics*. DK Publishing, 2000. Traces the history, discoveries, and devices of this fast-moving science.

Chirico, Joann. *Electronics*. NTC Publishing, 1995. This book explores career possibilities in electronics and electricity.

Engelbert, Phillis. *Technology in Action: Science Applied to Everyday Life*. Gale, 1998. A general look at technology and technical applications of scientific knowledge, with a section on computers and electronics.

Leon, George deLuca. *Electronics Projects for Young Scientists*.

Franklin Watts, 1991. Introduces the basic principles of electronics and includes project ideas such as a crystal radio, an intercom, and a pair of electronic dice.

Maxfield, Clive Max. *Bebop to the Boolean Boogie: An Unconventional Guide to Electronics Fundamentals, Components, and Processes*. Hightext Publications, 1995. This book covers the basics of electronics clearly, simply, and in an entertaining style.

Predko, Myke. *Digital Electronics Guidebook: With Projects!* McGraw-Hill, 2001. Introduces the nuts and bolts of digital electronics.

Rowh, Mark, and Dick Glass.

Opportunities in Electronics Careers, revised ed. McGraw-Hill/Contemporary Books, 1999. Check out the many electronics-related career opportunities available, featured in this 160-page book.

Slope, G. Randy. *TAB Electronics Guide to Understanding Electricity and Electronics*. 2nd ed. McGraw-Hill, 2002. A learn-as-you-go guide for readers of any electronics skill level.

Vcgt, Greg L. *Robotix Robot Inventor's Workshop*. Running Press Book Publishers, 2000. A handbook on the science of robotics.

Magazines

Nuts & Volts

430 Princeland Court
Corona, CA 92879
Telephone: 951-371-8497

Web site: <http://www.nutsvolts.com>

Popular Science

P.O. Box 420235

Palm Coast, FL 32142-0235

Toll-free telephone: 800-289-9399

Web site: <http://www.popsci.com>

Organizations and Web Sites

American Microsemiconductor Inc.

Web site:

<http://www.americanmicrosemi.com/information/tutorial>

ePanorama.net

Web site:

<http://www.epanorama.net>

Howstuffworks

Web site:

<http://electronics.howstuffworks.com>

101science.com

Web site: <http://www.101science.com/Radio.htm>

Electronics Parts and Suppliers

In most places, **Radio Shack** stores can be the best source for electronics parts. However, most Radio Shacks have reduced their parts inventories, which means you might have to look elsewhere to find all the parts you need for a project (or check out their Web site, <http://www.radioshack.com>). Electronics parts and kits also can be ordered over the Internet or via mail or toll-free telephone from various suppliers.

Whenever you go online, be sure you have your parent's permission first.

Allied Electronics

7151 Jack Newell Blvd. S.

Fort Worth, TX 76118

Toll-free telephone: 866-433-5722

Web site: <http://www.alliedelec.com>

C and H Sales Company

2176 East Colorado Blvd.

Pasadena, CA 91107

Toll-free telephone: 800-325-9465

Web site:

<http://www.candhsales.biz>

Carl's Electronics

484 Lakepark Ave., Suite 59

Oakland, CA 94610

Toll-free telephone: 866-664-0627

Web site: <http://www.electronickits.com>

Digi-Key Corporation

701 Brooks Ave. S.
Thief River Falls, MN 56701
Toll-free telephone: 800-344-4539
Web site: <http://www.digi-key.com>

Electronic Courseware Interactive

P.O. Box 17640
Kyle, TX 78640
Toll-free telephone: 512-268-2766
Web site: <http://www.eki.com>

Hobbytron.com

1053 South 1675 West
Orem, UT 84058
Toll-free telephone: 800-494-1778
Web site: <http://www.hobbytron.com>

MCM Electronics

650 Congress Park Drive
Centerville, OH 45459
Toll-free telephone: 800-543-4330
Web site: <http://www.mcmelectronics.com>

Mouser Electronics

1000 North Main St.
Mansfield, TX 76063
Toll-free telephone: 800-346-6873
Web site: <http://www.mouser.com>

Acknowledgments

The Boy Scouts of America thanks Mary Wiggins, director of educational initiatives for the Electronic Industries Foundation, for her assistance with this new edition of the *Electronics* merit badge pamphlet. The EIF strives to create new ways to engage young people in the pursuit of science and technology, including electronics.

We appreciate the Quicklist Consulting Committee of the Association for Library Service to Children, a division of the American Library Association, for its assistance with updating the resources section of this merit badge pamphlet.

Photo and Illustration Credits

American Museum of Radio,
www.americanradiomuseum.org,
courtesy—page 6 (*all foreground*)
©Jupiterimages.com—cover (*top right*,
top left); pages 12 (*top three*), 58,
64, 75–76 (*both*), 81 (*both*), and 90
Oklahoma University, courtesy—
page 89
©Photos.com—cover (*center right*,
bottom right, *circuit board at*
bottom left, *tools at center left*);
pages 4, 6 (*background*), 14,
26–28 (*all*), 66 (*top*), 87 (*bottom*),
and 91–93 (*all*)

Ultimate Symbols Inc.,
©1996–2000—page 49
(*recycle symbol*)

Wikipedia.org, courtesy—pages 41
(*bottom*) and 66 (*bottom*)

All other photos and illustrations not mentioned above are the property of or are protected by the Boy Scouts of America.

John McDearmon—all illustrations
on pages 21–25, 29, 31–41, 55–56,
62–63, 68, 72–74, 79–80, and 84–87

MERIT BADGE LIBRARY

Though intended as an aid to Boy Scouts, Varsity Scouts, and qualified Venturers in meeting merit badge requirements, these pamphlets are of general interest and are made available by many schools and public libraries. The latest revision date of each pamphlet might not correspond with the copyright date shown below, because this list is corrected only once a year, in January. Any number of merit badge pamphlets may be revised throughout the year; others are simply reprinted until a revision becomes necessary.

If a Scout has already started working on a merit badge when a new edition for that pamphlet is introduced, he should continue to use the same merit badge pamphlet to earn the badge. He should fulfill the requirements listed in the pamphlet he was using when he began. In other words, the Scout need not start all over again with the new pamphlet and possibly revised requirements.

Year	Merit Badge Pamphlet	Year	Merit Badge Pamphlet	Year	Merit Badge Pamphlet
2002	American Business	2002	Engineering	2000	Photography
2005	American Cultures	2005	Entrepreneurship	2006	Pioneering
2005	American Heritage	2005	Environmental Science	2006	Plant Science
2006	American Labor	2006	Family Life	2004	Plumbing
2006	Animal Science	2006	Farm Mechanics	1997	Poetry
2006	Archaeology	2006	Fine Art	2003	Public Health
2004	Artery	2004	Fire Safety	2004	Public Speaking
2004	Architecture	2004	First Aid	2007	Pulp and Paper
2006	Astronomy	2004	Fish and Wildlife	2001	Radio
2006	Athletics	2004	Management	2004	Railroading
2000	Auto Mechanics	2006	Fishing	2002	Reading
2006	Aviation	2002	Fly-Fishing	2002	Reptiles and
2007	Backpacking	2005	Forestry	2005	Amphibian Study
2003	Basketry	2002	Gardening	2001	Rifle Shooting
2005	Bird Study	2003	Genealogy	2006	Rowing
2005	Bugling (see Music)	2005	Geology	2006	Safety
2005	Camping	2005	Golf	2002	Salesmanship
2004	Canoing	2006	Graphic Arts	2003	Scholarship
2004	Chemistry	2007	Hiking	2007	Scouting
2001	Chromatography	2002	Home Repairs	2007	Shotgun Shooting
2001	Citizenship in the	2004	Horsemanship	2005	Skating
2005	Community	2001	Indian Lore	2004	Small-Boat Sailing
2005	Citizenship in the Nation	2002	Insect Study	2002	Snow Sports
2005	Citizenship in the World	2006	Journalism	2002	Soil and Water
2006	Climbing	2002	Landscape Architecture	2004	Conservation
2003	Coin Collecting	2006	Law	2004	Spaces Exploration
2003	Collections	2002	Leatherwork	2006	Sports Collecting
2006	Composite Materials	2003	Lifesaving	2007	Stamp Collecting
2006	Computers	2003	Mammal Study	2002	Surveying
2007	Cooking	2006	Medicine	2002	Swimming
2005	Crime Prevention	2006	Metallurgy	2007	Textiles
2006	Cycling	2007	Model Design and Building	2003	Theater
2006	Disabilities Awareness	2005	Motorboating	1992	Traffic Safety
2003	Dog Care	2003	Music and Bugling	2006	Truck Transportation
1993	Drafting	2005	Nature	2005	Veterinary Medicine
2004	Electricity	2005	Nuclear Science	2007	Water Sports
2004	Electronics	1993	Oceanography	2006	Weather
2003	Emergency Preparedness	2004	Orientation	2005	Whitewater
2003	Energy	2004	Painting	2007	Wilderness Survival
2005	Pets	2003	Personal Fitness	2006	Wood Carving
		2003	Personal Management	2003	Woodwork

BOY SCOUTS OF AMERICA • SUPPLY DIVISION

NATIONAL DISTRIBUTION CENTER
2109 Westinghouse Boulevard
P.O. Box 7143
Charlotte, NC 28241-7143

www.scoutstuff.org

DIRECT MAIL CENTER
P.O. Box 909
Pineville, NC 28134-0909

For fast credit card orders—
call BSA operators toll-free
1-800-323-0732

VISA, MasterCard, American Express—